

Smart Professional Surveillance System User's Manual

Version 2.0.4

Table of Contents

CYBERSECURITY RECOMMENDATIONS	VIII
FOREWORD	XI
1. SMARTPSS OVERVIEW	1
1.1 SmartPSS Overview	1
1.2 SmartPSS Interface	1
2. LOGIN.....	4
2.1 Installing SmartPSS	4
2.2 Initializing Device	4
2.3 Login SmartPSS	6
2.4 Reset Password.....	8
3. DEVICES	11
3.1 Add Device	11
3.1.1 Auto Search	11
3.1.2 Manually Add	13
3.1.3 Batch Import and Add Device	14
3.2 Modify Device Info.....	15
3.3 Modify IP Address	15
3.4 Delete Device	17
3.4.1 Single Delete	17
3.4.2 Batch Delete	17
4. LIVE	19
4.1 Introduction to Interface	19
4.2 Live View	20
4.2.1 Start Live.....	20
4.2.2 Live Operation	21
4.2.3 Adjust Monitor Window Number	23
4.3 E-Map.....	25

4.3.1	New Map	25
4.3.2	Preview Map or Hot Zone	28
4.4	Config IVS Channel	28
4.4.1	Scene Config	29
4.4.2	General Behavior Analytics	31
4.4.2.1	Enable Behavior Analytics	31
4.4.2.2	Calibration	32
4.4.2.3	Set Detection Zone	33
4.4.2.4	IVS Rule	34
4.4.2.5	Parameters.....	54
4.4.3	Face Detection.....	55
4.4.3.1	Enabling Face Detection	55
4.4.3.2	Configuring Face Detection Rules	56
4.4.4	People Counting	61
4.4.4.1	Enabling People Counting	61
4.4.4.2	Calibration	62
4.4.4.3	Configuring People Counting	62
4.4.5	Heat Map	66
4.4.5.1	Enabling Heat Map.....	66
4.4.5.2	Configuring Heat Map Rule.....	67
4.5	Smart Track Config (Fisheye+Dome)	71
4.5.1	Calibration Requirement	71
4.5.2	Calibrating Camera.....	72
4.5.3	Achieving Smart Track (Fisheye and Dome).....	74
4.6	Smart Track Config (Dome+Bullet).....	76
4.6.1	Calibration Requirement	76
4.6.2	Calibrating Camera.....	77
4.6.3	Achieving Smart Track (Bullet and Dome)	80
4.7	Smart Tracking (Smart Capture System)	84
4.8	PTZ.....	85
4.8.1	Preset.....	87
4.8.2	Tour.....	88
4.8.3	Scan.....	89
4.8.4	Pattern	89
4.8.5	Enabling Windshield Wiper.....	89
4.9	Fisheye View Mode.....	90
4.10	Device Preview via NKB1000 Keyboard	91
5.	TOUR & TASK.....	93
5.1	Config Task Plan	93

5.2	Enabling Task	97
6.	PLAYBACK	98
6.1	Playback	98
6.2	Playback Device Record	100
6.3	Exporting Device Record	101
6.4	Playback Device Picture	103
6.5	Export Device Picture	104
6.6	Playback Local Record	105
6.7	Export Local Record	106
6.8	Playback Local Picture	108
7.	LOG SEARCH	110
7.1	Searching Client Log	110
7.2	Searching Device Log	110
8.	SYSTEM CONFIG	112
9.	USER	116
9.1	Role Info	116
9.2	User	118
10.	DEVICE CONFIG	120
11.	EVENT CONFIG	123
11.1	Event Type	123
11.2	Event Alarm Link Config	126
11.2.1	Link Notice	127
11.2.2	Link Video	128
11.2.3	Link Alarm Output	130
11.2.4	Arm Time	131
11.3	Event View	132
12.	VIDEO WALL	134

12.1	Video Wall	134
12.2	Config Favorites	136
12.2.1	Add Favorite.....	136
12.2.2	Delete Favorite	138
12.2.3	Delete Channel	138
12.2.4	Change Favorite Name.....	139
12.3	Set Video Wall and Output	139
12.4	Scheme Tour on Video Wall.....	142
12.5	Playback on Video Wall	144
12.6	Operating Video Wall by NKB1000.....	144
13.	PEOPLE COUNT	146
13.1	People Counting.....	146
13.2	Flow Statistics	148
14.	HEAT MAP.....	150
15.	PC-NVR.....	151
15.1	Disk Manager.....	151
15.2	Channel Management	152
15.3	Set Record Plan.....	153
15.4	Version Info	154
15.5	Modify Port	154
15.6	Modify Password.....	155
16.	ACCESS	157
16.1	Console	157
16.1.1	Organizations/Zones.....	158
16.1.1.1	E-Map.....	158
16.1.1.2	Device Control.....	158
16.1.2	List/View.....	161
16.1.2.1	Monitor and Control Access	161
16.1.2.2	Live Video/E-map.....	161
16.1.3	Event.....	164

16.2	User Management	164
16.2.1	Department Management	165
16.2.2	User Management	166
16.2.2.1	Set Card Type	166
16.2.2.2	Add User	166
16.2.2.3	Edit Personnel.....	173
16.2.2.4	Delete Personnel.....	174
16.2.2.5	Export Personnel Info.....	174
16.2.2.6	Issue Card	174
16.2.2.7	Freeze Card	176
16.2.2.8	Unfreeze Card.....	176
16.2.2.9	Card Loss Report	176
16.3	Permission Management.....	176
16.3.1	Period Setup	176
16.3.1.1	Normal Period	176
16.3.2	Holiday Setup	177
16.3.3	Holiday Management.....	178
16.3.4	Door Group Right.....	179
16.3.4.1	Add Door Group	180
16.3.4.2	Modify Door Group Info.....	181
16.3.4.3	Add Personnel Permission.....	181
16.3.4.4	Delete Info.....	183
16.3.5	User Right	183
16.3.6	First Card Unlock	185
16.3.7	Multi-card Unlock	187
16.3.8	Anti-pass Back	191
16.3.9	Inter-door Lock.....	194
16.3.10	Remote Verification	196
16.4	Event Configuration.....	197
16.5	Log.....	200
17.	ATTENDANCE.....	202
17.1	Console.....	202
17.1.1	Console Introduction.....	202
17.1.2	ACS Attendance Node Setup	203
17.1.3	Extract Card Info.....	204
17.2	User	204
17.2.1	Department/User	204
17.2.2	Permission	204
17.2.2.1	Enable Attendance Right	204
17.2.2.2	Disable Attendance Right	207

17.3	Set Attendance	208
17.3.1	Set Attendance Timezone	208
17.3.2	Set Attendance Shift	210
17.3.3	Set Holiday.....	213
17.3.4	Configuring Player	214
17.4	Shift	215
17.4.1	General Shift.....	215
17.4.2	Temporary Shift	218
17.4.3	Set Default Shift for New User.....	220
17.5	Report.....	221
17.5.1	Extract Attendance Info	221
17.5.2	Attendance Statistics	222
17.5.3	Exception Attendance Processing.....	223
18.	FACE RECOGNITION	225
18.1	Face Recognition Settings	225
18.1.1	Managing face library	225
18.1.1.1	Adding face library	225
18.1.1.2	Deleting Face Library	227
18.1.1.3	Editing Face Library	228
18.1.2	Person Management	229
18.1.2.1	Adding Person.....	229
18.1.2.2	Importing/Exporting Face Library Data	235
18.1.2.3	Modifying Person Information	237
18.1.2.4	Deleting Person.....	237
18.1.3	Arming Face Library	239
18.1.4	Face Collection	240
18.2	Face Recognition Applications	242
18.2.1	Video Preview	242
18.2.2	Searching for Snapshots	245
18.2.2.1	Search by Images	245
18.2.2.2	Conditional Search.....	248
18.2.3	Search Comparison Results	252

Welcome

Thank you for using our Smart Professional Surveillance System (SmartPSS)!
This user's manual is designed to be a reference tool for operation of your system.
Here you can find detailed operation information about SmartPSS.

Cybersecurity Recommendations

Mandatory actions to be taken towards cybersecurity

1. Change Passwords and Use Strong Passwords

The number one reason systems get “hacked” is due to having weak or default passwords. It is recommended to change default passwords immediately and choose a strong password whenever possible. A strong password should be made up of at least 8 characters and a combination of special characters, numbers, and upper and lower case letters.

2. Update Firmware

As is standard procedure in the tech-industry, we recommend keeping NVR, DVR, and IP camera firmware up-to-date to ensure the system is current with the latest security patches and fixes.

“Nice to have” recommendations to improve your network security

1. Change Passwords Regularly

Regularly change the credentials to your devices to help ensure that only authorized users are able to access the system.

2. Enable IP Filter

Enabling your IP filter will prevent everyone, except those with specified IP addresses, from accessing the system.

3. Forward Only Ports You Need

- Only forward the HTTP and TCP ports that you need to use. Do not forward a huge range of numbers to the device. Do not DMZ the device's IP address.
- You do not need to forward any ports for individual cameras if they are all connected to a recorder on site; just the NVR is needed.

4. Disable Auto-Login on SmartPSS

Those using SmartPSS to view their system and on a computer that is used by multiple people should disable auto-login. This adds a layer of security to prevent users without the appropriate credentials from accessing the system.

5. Use a Different Username and Password for SmartPSS

In the event that your social media, bank, email, etc. account is compromised, you would not want someone collecting those passwords and trying them out on your video surveillance system. Using a different username and password for your security system will make it more difficult for someone to guess their way into your system.

6. UPnP

- UPnP will automatically try to forward ports in your router or modem. Normally this would be a good thing. However, if your system automatically forwards the ports and you leave the credentials defaulted, you may end up with unwanted visitors.
- If you manually forwarded the HTTP and TCP ports in your router/modem, this feature should be turned off regardless. Disabling UPnP is recommended when the function is not used in real applications.

7. SNMP

Disable SNMP if you are not using it. If you are using SNMP, you should do so only temporarily, for tracing and testing purposes only.

8. Multicast

Multicast is used to share video streams between two recorders. Currently there are no known issues involving Multicast, but if you are not using this feature, deactivation can enhance your network security.

9. Physically Lock down the Device

Ideally, you want to prevent any unauthorized physical access to your system. The best way to achieve this is to install the recorder in a lockbox, locking server rack, or in a room that is behind a lock and key.

10. Isolate NVR and IP Camera Network

The network your NVR and IP camera resides on should not be the same network as your public computer network. This will prevent any visitors or unwanted guests from getting access to the same network the security system needs in order to function properly.

FCC Information



- Changes or modifications not expressly approved by the party responsible for compliance could void the user's authority to operate the equipment.

FCC conditions:

- This device complies with part 15 of the FCC Rules. Operation is subject to the following two conditions:

This device may not cause harmful interference.

This device must accept any interference received, including interference that may cause undesired operation.

FCC compliance:

- This equipment has been tested and found to comply with the limits for a digital device, pursuant to part 15 of the FCC Rules. This equipment generate, uses and can radiate radio frequency energy and, if not installed and used in accordance with the guide, may cause harmful interference to radio communication.

For class A device, these limits are designed to provide reasonable protection against harmful interference in a commercial environment. Operation of this equipment in a residential area is likely to cause harmful interference in which case the user will be required to correct the interference at his own expense.

For class B device, these limits are designed to provide reasonable protection against harmful interference in a residential installation. However, there is no guarantee that interference will not occur in a particular installation. If this equipment does cause harmful interference to radio or television reception, which can be determined by turning the equipment off and on, the user is encouraged to try to correct the interference by one or more of the following measures:

- Reorient or relocate the receiving antenna.
- Increase the separation between the equipment and receiver.
- Connect the equipment into an outlet on a circuit different from that to which the receiver is connected.
- Consult the dealer or an experienced radio/TV technician for help.





Foreword

General

This user's manual (hereinafter referred to be "the Manual") introduces the functions and operations of the XXX device (hereinafter referred to be "the Device").

Safety Instructions

The following categorized signal words with defined meaning might appear in the Manual.

Signal Words	Meaning
 DANGER	Indicates a high potential hazard which, if not avoided, will result in death or serious injury.
 WARNING	Indicates a medium or low potential hazard which, if not avoided, could result in slight or moderate injury.
 CAUTION	Indicates a potential risk which, if not avoided, could result in property damage, data loss, lower performance, or unpredictable result.
 TIPS	Provides methods to help you solve a problem or save you time.
 NOTE	Provides additional information as the emphasis and supplement to the text.

Revision History

No.	Version	Revision Content	Release Time
1	V2.0.2	<ol style="list-style-type: none">1. Update instruction icon.2. Optimize description of Installation and Login.3. Optimize chapter of Access Control.4. Add chapter of Attendance.5. Add chapter of Alarm Host.	February 27, 2018
2	V2.0.4	<ol style="list-style-type: none">1. Add people density menu introduction on the live interface.2. Add face acquisition function for the chapter of face recognition.3. Add the function of flow statistics.4. Revise the contents of event config, add alarm event.5. Add smart tracking (smart capture system)	January 30, 2019

Privacy Protection Notice

As the device user or data controller, you might collect personal data of others' such as face, fingerprints, car plate number, Email address, phone number, GPS and so on. You need to be in compliance with the local privacy protection laws and regulations to protect the legitimate rights and interests of other people by implementing measures include but not limited to: providing clear and visible identification to inform data subject the existence of surveillance area and providing related contact.

About the Manual

- The Manual is for reference only. If there is inconsistency between the Manual and the actual product, the actual product shall prevail.
- We are not liable for any loss caused by the operations that do not comply with the Manual.
- The Manual would be updated according to the latest laws and regulations of related regions.
- For detailed information, see the paper manual, CD-ROM, QR code or our official website. If there is inconsistency between paper manual and the electronic version, the electronic version shall prevail.
- All the designs and software are subject to change without prior written notice. The product updates might cause some differences between the actual product and the Manual. Please contact the customer service for the latest program and supplementary documentation.
- There still might be deviation in technical data, functions and operations description, or errors in print. If there is any doubt or dispute, please refer to our final explanation.
- Upgrade the reader software or try other mainstream reader software if the Guide (in PDF format) cannot be opened.
- All trademarks, registered trademarks and the company names in the Manual are the properties of their respective owners.
- Please visit our website, contact the supplier or customer service if there is any problem occurred when using the device.
- If there is any uncertainty or controversy, please refer to our final explanation.

About the Guide

- The Guide is for reference only. If there is inconsistency between the Guide and the actual product, the actual product shall prevail.
- We are not liable for any loss caused by the operations that do not comply with the Guide.
- The Guide would be updated according to the latest laws and regulations of related regions. For detailed information, see the paper manual, CD-ROM, QR code or our official website. If there is inconsistency between paper manual and the electronic version, the electronic version shall prevail.
- All the designs and software are subject to change without prior written notice. The product updates might cause some differences between the actual product and the Guide. Please contact the customer service for the latest program and

supplementary documentation.

- There still might be deviation in technical data, functions and operations description, or errors in print. If there is any doubt or dispute, please refer to our final explanation.
- Upgrade the reader software or try other mainstream reader software if the Guide (in PDF format) cannot be opened.
- All trademarks, registered trademarks and the company names in the Guide are the properties of their respective owners.
- Please visit our website, contact the supplier or customer service if there is any problem occurred when using the device.
- If there is any uncertainty or controversy, please refer to our final explanation.

1. SmartPSS Overview

1.1 SmartPSS Overview

SmartPSS is an abbreviation for Smart Professional Surveillance System.

The software is to manage small quantity security surveillance devices. It releases with the device and does not support the products from other manufacturers. It has the following features:

- Software password reset.
- View real-time video of several camera channels.
- View the playback video files from various cameras.
- Support multiple scheduled arms to realize auto PC guard.
- Support e-map; you can clearly view and manage all device locations.
- Video wall preview.
- People count and heat map.
- Search and export log.
- Support config and management of A&C device.
- Support config and management of intercom device.
- Support config and management of time attendance.
- Support config and management of alarm controller.

1.2 SmartPSS Interface

SmartPSS software interface includes 5 parts: function tab, system info, function list, shortcut, and help. See Figure 1-1.

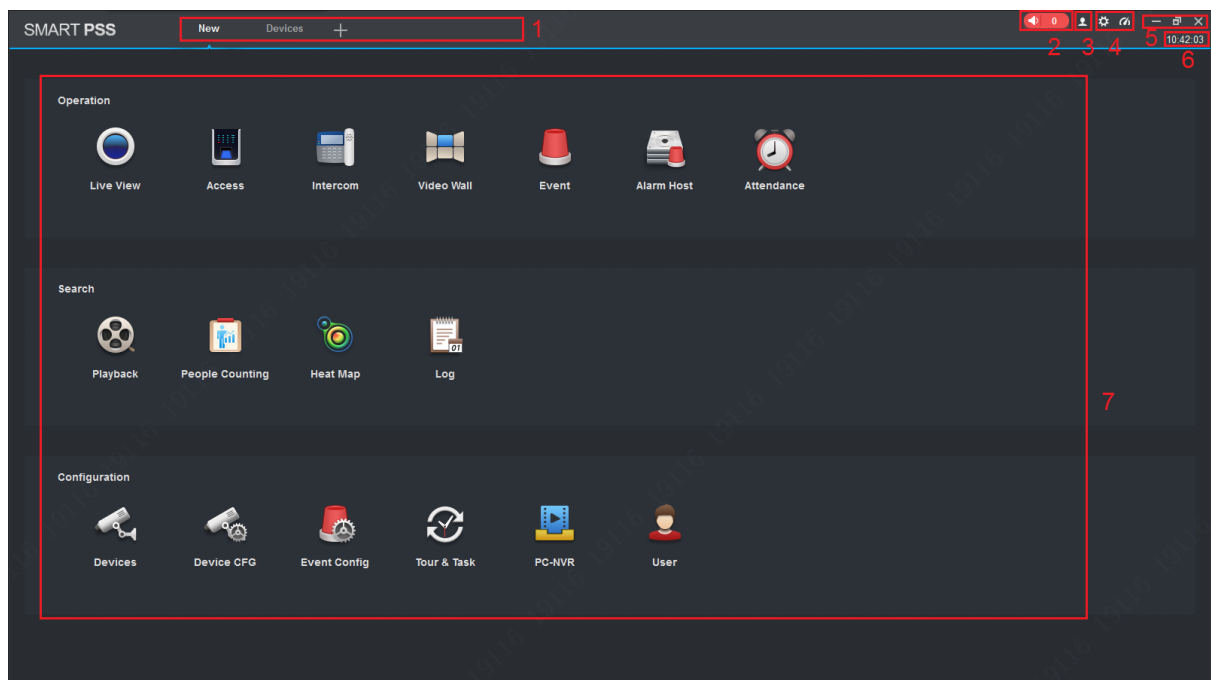

















Figure 1-1

No	Name	Note
1	Function tab	In default status, it shows Device tab, New tab and  . Click  , you can add new tab. If you open function in New tab, it enters corresponding function interface, and meantime tab name is updated to new function name.
2	Event	<ul style="list-style-type: none"> ●  and . Click icon to switch event alarm between mute and sound. ●  (Example only), click icon to enter Event interface.
3	User	<ul style="list-style-type: none"> ● Click , select lock screen. ● Click , select switch user. ● Click , select help manual. ● Click , select about, to show software version and date. ● Click , select user wizard to show new function and features.
4	System Management	<ul style="list-style-type: none"> ● Click , enter system config interface. It supports base, preview and playback, device manager and etc. ● Click , show system CPU occupancy status and memory. If CPU occupancy is high, the icon will become red as warning.
5	Window	<ul style="list-style-type: none"> ● Click , minimize window. ● Click , maximize window. ● Click , to restore window. ● Click , exit.
6	System Time	Current system time.

7	Function List	<p>Function list has operation area, search area and config area.</p> <ul style="list-style-type: none"> ● Live View Connect to camera, to achieve live preview. It supports local record, snapshot, audio on, talk, instant playback, zoom in video, switch stream, config device parameter, config intelligent channel and etc. ● Access Connect to access control device, support A&C monitoring, e-map, video link, user management and etc. ● Intercom Connect to intercom device, support call, live preview, remote unlock, send info and etc. ● Video Wall Video on wall. ● Event View, process and mark event. ● Playback Playback and export device record, device picture, local record and local picture. ● People Counting View and export people count info within a certain period, support contrast of different channels or people count info. ● Heat Map Search and export heat map within a certain period. ● Log Search and export client log and device log. ● Devices Search and add device, batch import or export device info, modify and delete device info. ● Device CFG Configure camera, network, event, storage and system. ● Event Config Include channel event, alarm controller event, external alarm and device event. You can set alarm notice, alarm link video, alarm output and arm time. ● Tour&Task Config and manage tour plan. ● PC-NVR Connect to NVR, manage NCR disk and set record plan. ● User Add, modify and delete user and role, and manage role and user right.
---	---------------	---

Chart 1-1

2. Login

The chapter introduces how to login SmartPSS. For first time login, you shall initialize the device, set login password. If you forget the password, you can reset password via password reset function.

2.1 Installing SmartPSS

Please make sure the package is unzipped before installation. Please contact technical support if necessary.

Double click installer, such as “SmartPSS_ChnEng_Win32_IS_V2.002.0000005.0.R.180803.exe”. Install by default according to the interface tips. The software name is only an example; please refer to the actual name for details.



After installation is completed, the shortcut  will be displayed on the desktop, double click it to open client and then installation is successfully.

2.2 Initializing Device

After SmartPSS installation is complete, you login it for the first time. Please follow system instructions to set admin login password and password security. This password set here is used to login system. Password security requires answering security questions to reset password.

Step 1



Double click . See Figure 2-1.

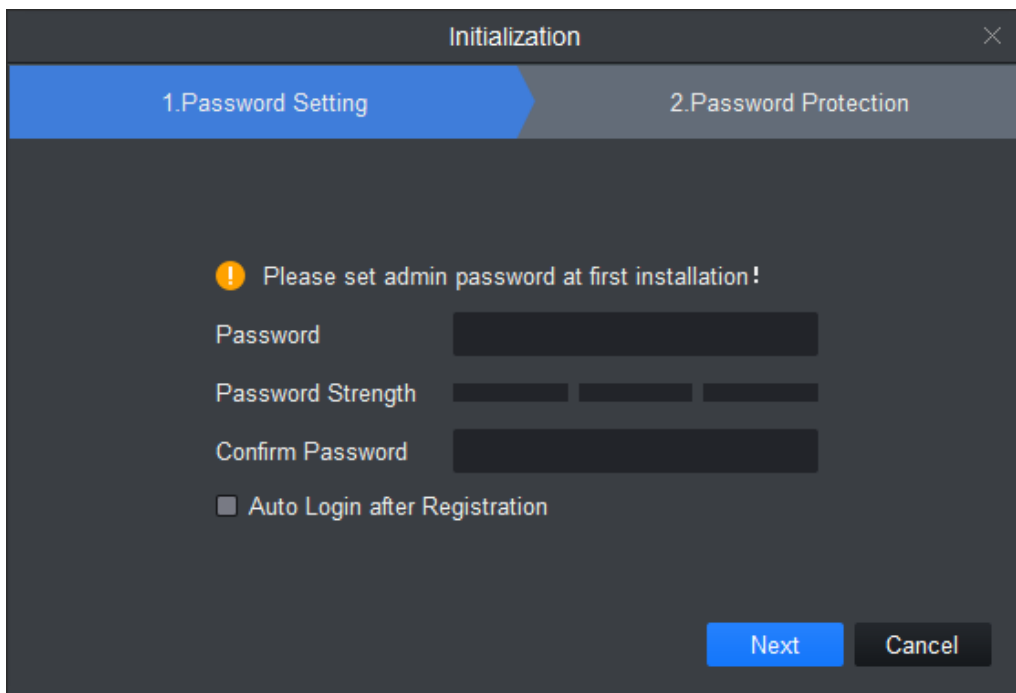

The image shows a screenshot of the 'Initialization' window in SmartPSS. The window has a dark grey background and a title bar with the text 'Initialization' and a close button. There are two tabs: '1.Password Setting' (active, highlighted in blue) and '2.Password Protection'. Below the tabs, there is a warning icon (exclamation mark in a yellow circle) followed by the text 'Please set admin password at first installation!'. There are three input fields: 'Password', 'Password Strength' (with a progress indicator), and 'Confirm Password'. Below these fields is a checkbox labeled 'Auto Login after Registration'. At the bottom right, there are two buttons: 'Next' (blue) and 'Cancel' (grey).

Figure 2-1

Step 2

Set password. See Figure 2-2.

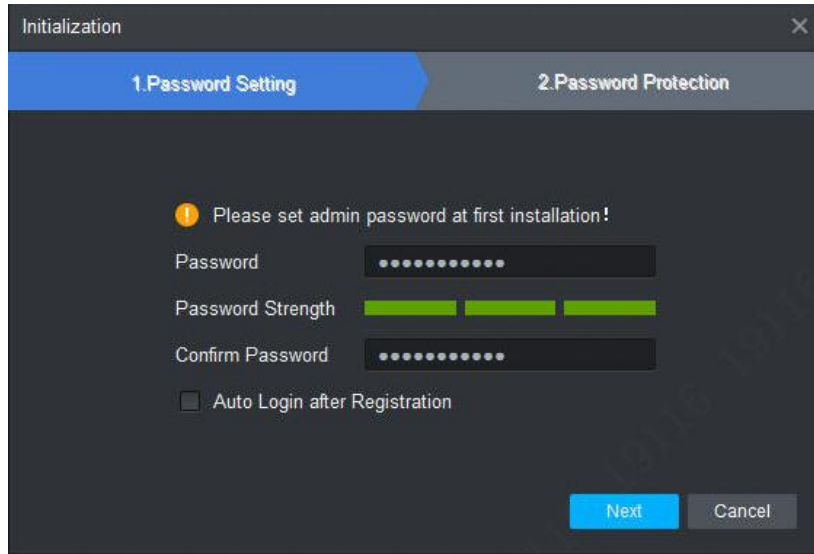

Figure 2-2

Parameter	Note
Password	Password can be 8~32 digits without space. It contains at least two types of upper case, lower case, number and symbol (except “” “” “.” “.” or “&”).
Password Strength	It feedbacks password complexity. Red means password is not complex enough, and greens means password complexity is OK. Please set password according to its strength.
Confirm Password	Match password set above.
Auto login after registration	Enable this option, so when registration complete, you will automatically log in the system.

Chart 2-1

Step 3

Click Next. The interface of Password Protection is displayed. See Figure 2-3.

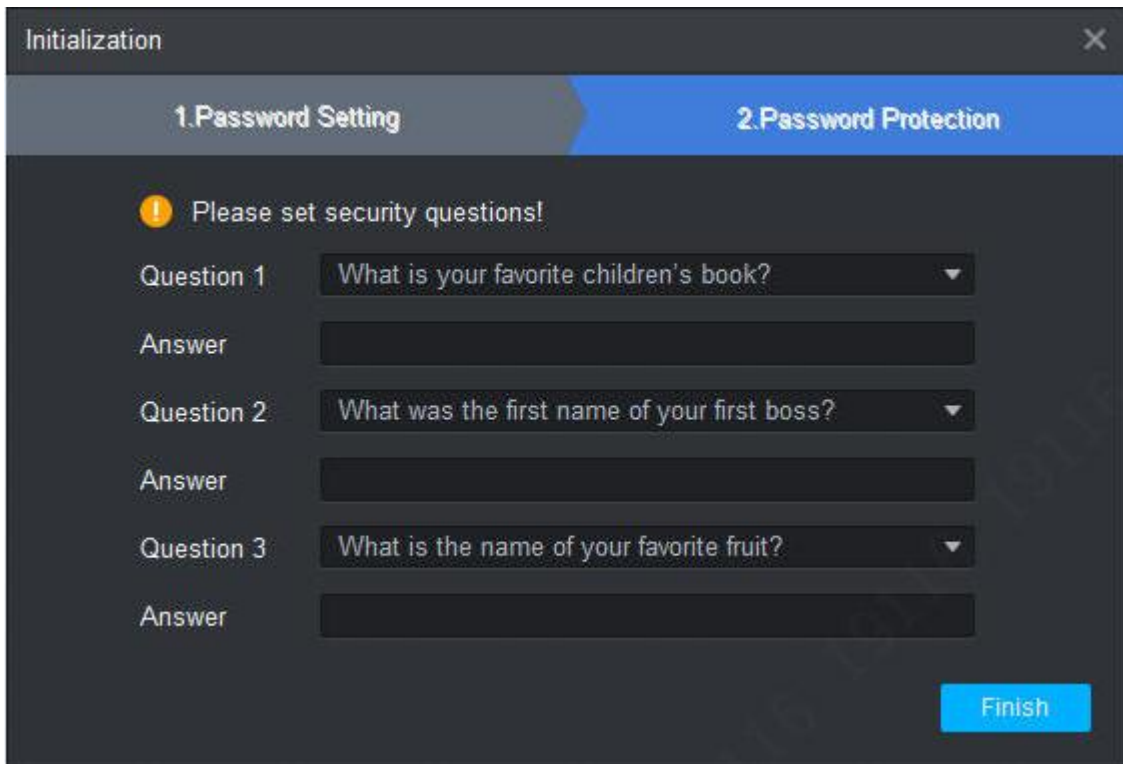

Figure 2-3

Step 4

Select questions and answer. In case you forget password, you may reset password through these questions.

Step 5

Click **Finish** and save config.

2.3 Login SmartPSS

After device initialization complete, enter username and login password.

Step 1



Double click . See Figure 2-4.

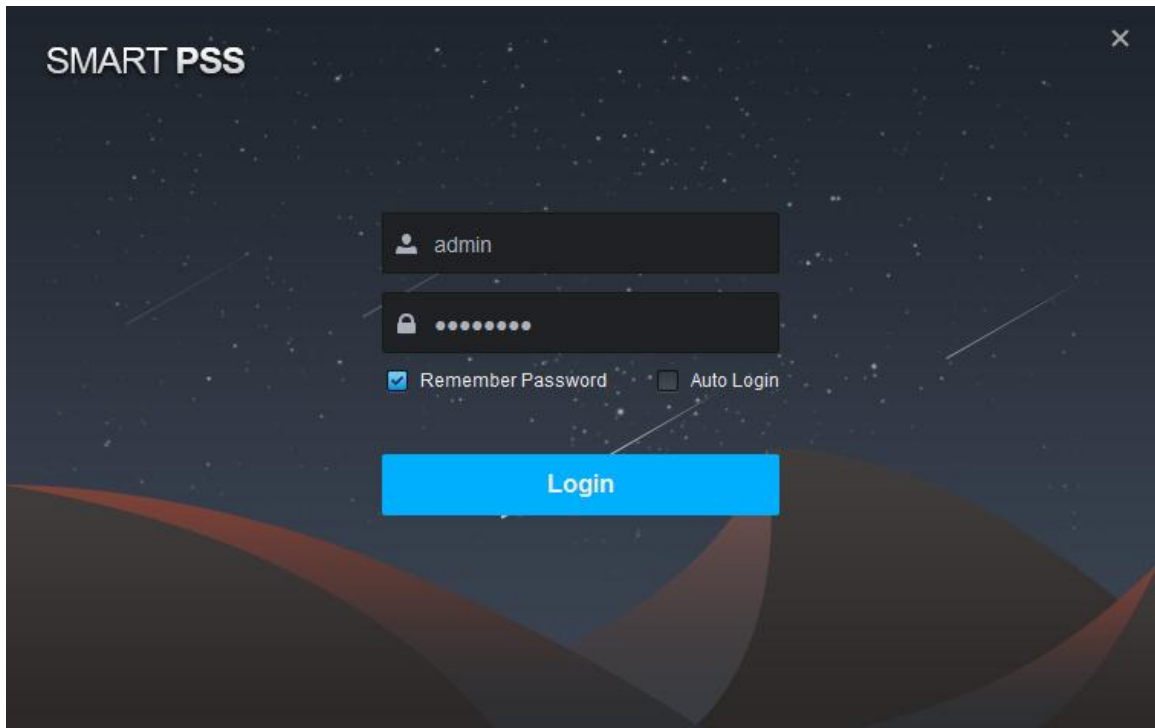

Figure 2-4

Step 2

Set parameters. See Chart 2-2.



Parameter	Note
	Enter username and password.
	
Remember password	Select it, system remember password and at next time of login, this password will be remembered.
Auto Login	Select it, it auto remember password, and it will auto login at next time.
Forget password	When you forget password, you can answer security question to reset password. See 2.4 Reset Password

Chart 2-2

Step 3

Click Login. The interface of device management is displayed. See Figure 2-5.



If it is the first time login, the system will show wizard of user to introduce new function and features.

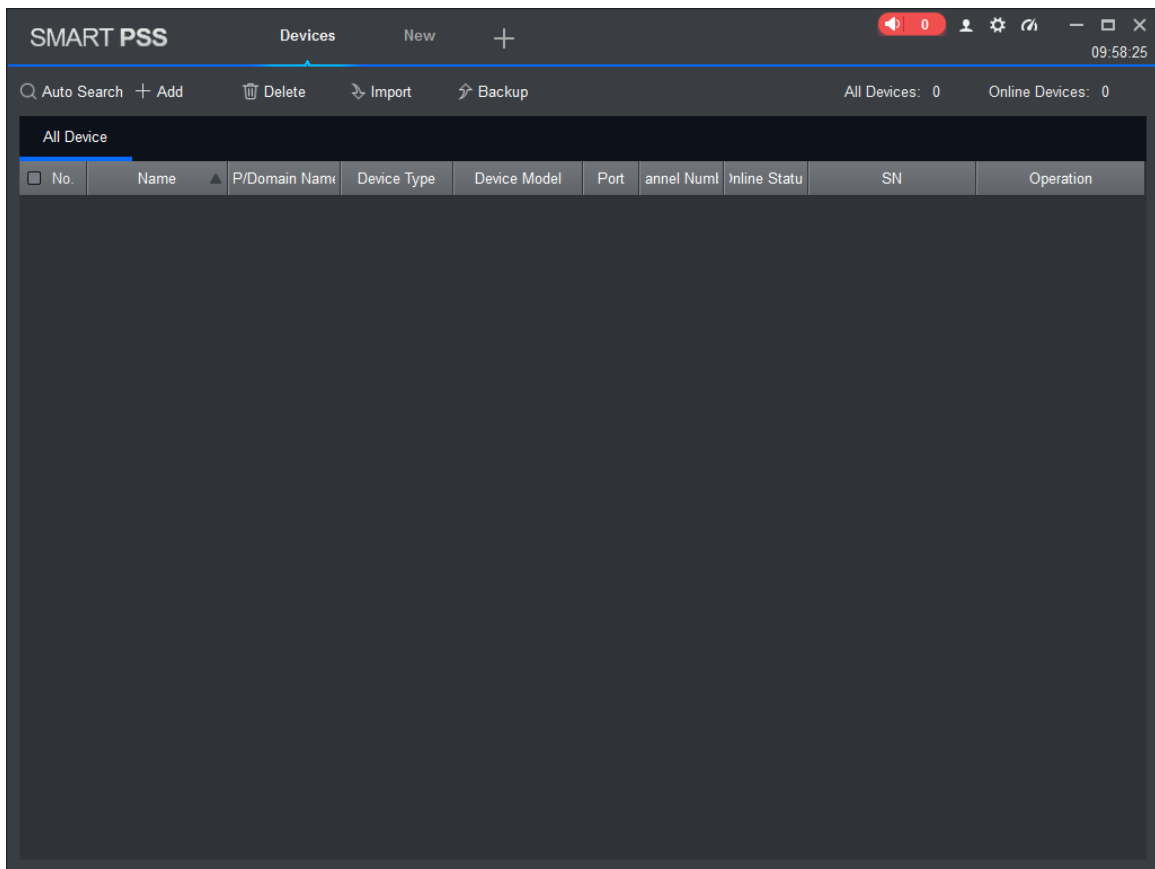

Figure 2-5

2.4 Reset Password

When you forget password, please answer security question to reset password.

Step 1



Double click . See Figure 2-6.

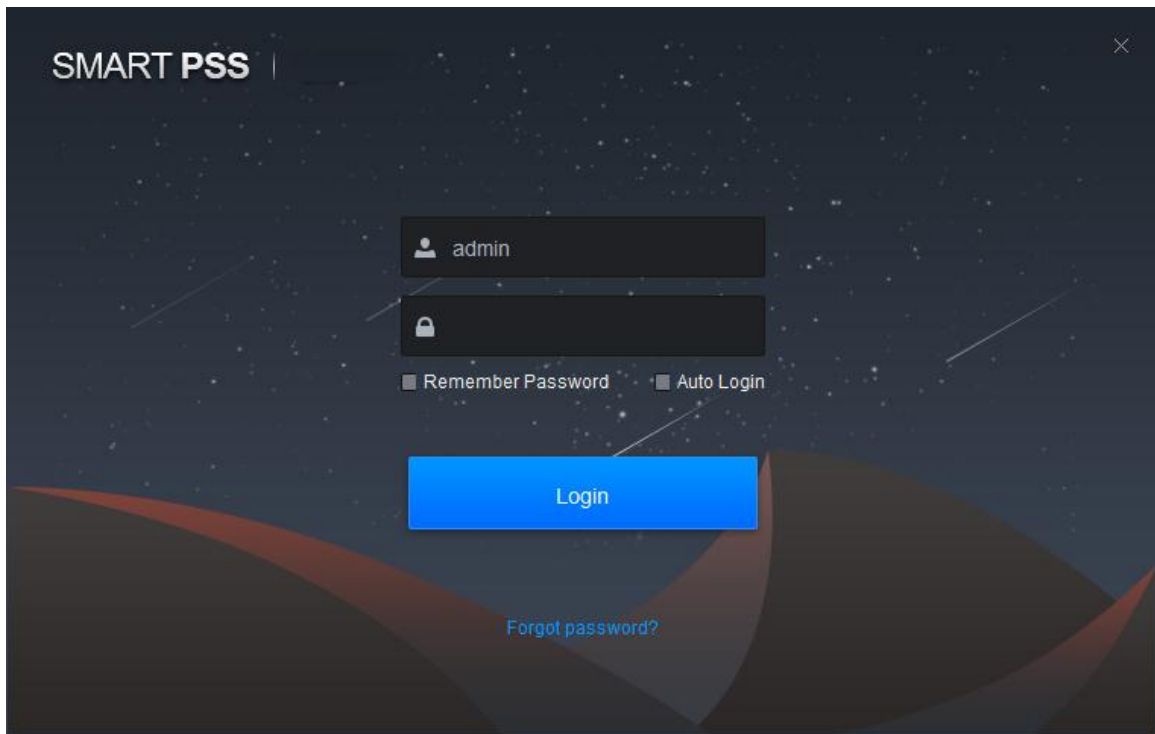

Figure 2-6

Step 2

Click **Forgot password?**. The interface of security question is displayed. See Figure 2-7.

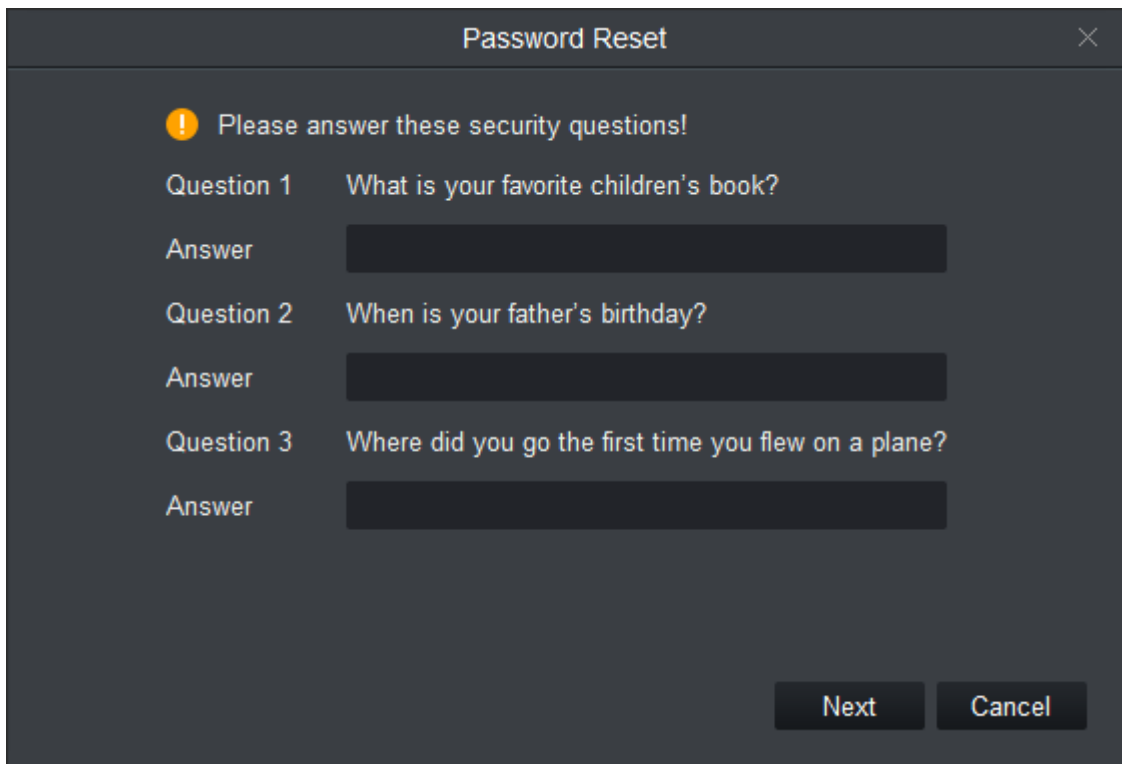

Figure 2-7

Step 3

Answer security question, click **Next**. See Figure 2-8.

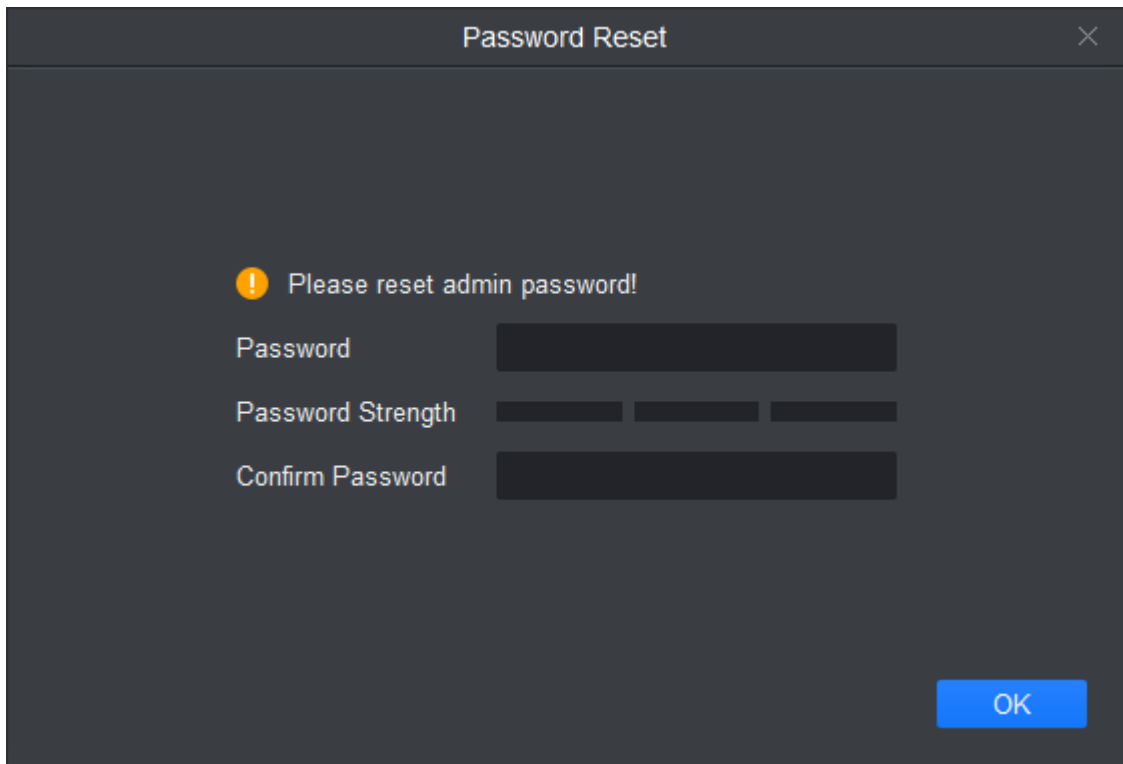

Figure 2-8

Step 4

Set password. For parameter details, see Chart 2-3.

Parameter	Note
Password	Password can be 8~32 digits without space. It contains at least two types of upper case, lower case, number and symbol (except “” , “” , “,” , “.,” or “&”).
Password Strength	Feedback password strength. Red means weak password and green means secure password.
Confirm Password	Match password set above.

Chart 2-3

Step 5

Click OK and save config.

3. Devices

SmartPSS supports to add a single device or batch device (i.e. IPC, NVR) via auto search. You also can config and operate device.

3.1 Add Device

SmartPSS supports to add device via multiple methods, please select method to add device according to device quantity, segment and etc.

3.1.1 Auto Search

You must add device as batch and make them in the same segment, or if you do not know device IP, you can uses this method to add device when you only know device segment.

Step 1

On the Devices interface, click Search.

Step 2

Set device segment and click Auto Search. See Figure 3-1.



- Click Refresh, to refresh searched device.
- Check device IP you want to modify, click Modify IP to change IP. See 3.3 Modify IP

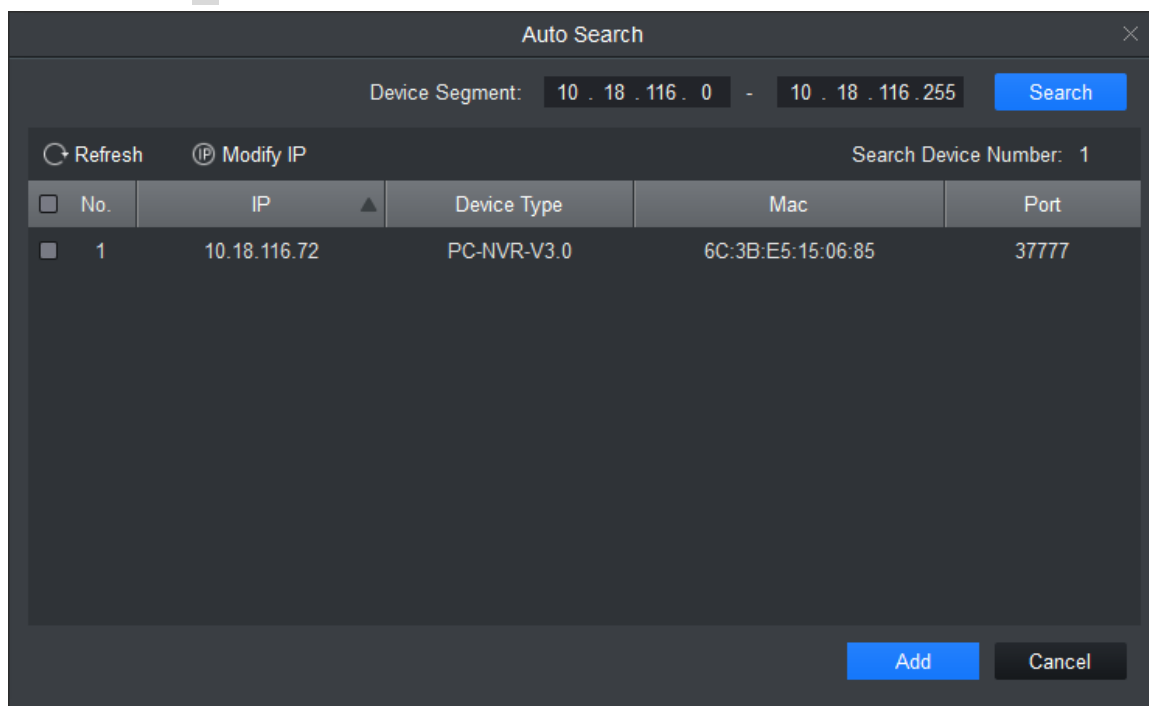

Figure 3-1

Step 3

Check device you want to add, click Add.

Step 4

Click OK. Login box pops up.

Step 5

Enter device username and password. Click OK. System shows device list added. See Figure 3-2.



After device is added, it stays at auto search page, you can continue to add device or click Cancel to exit.

After device is added, SmartPSS auto logins device. Login is successful, then online status changes to “online”, otherwise it is “offline”.

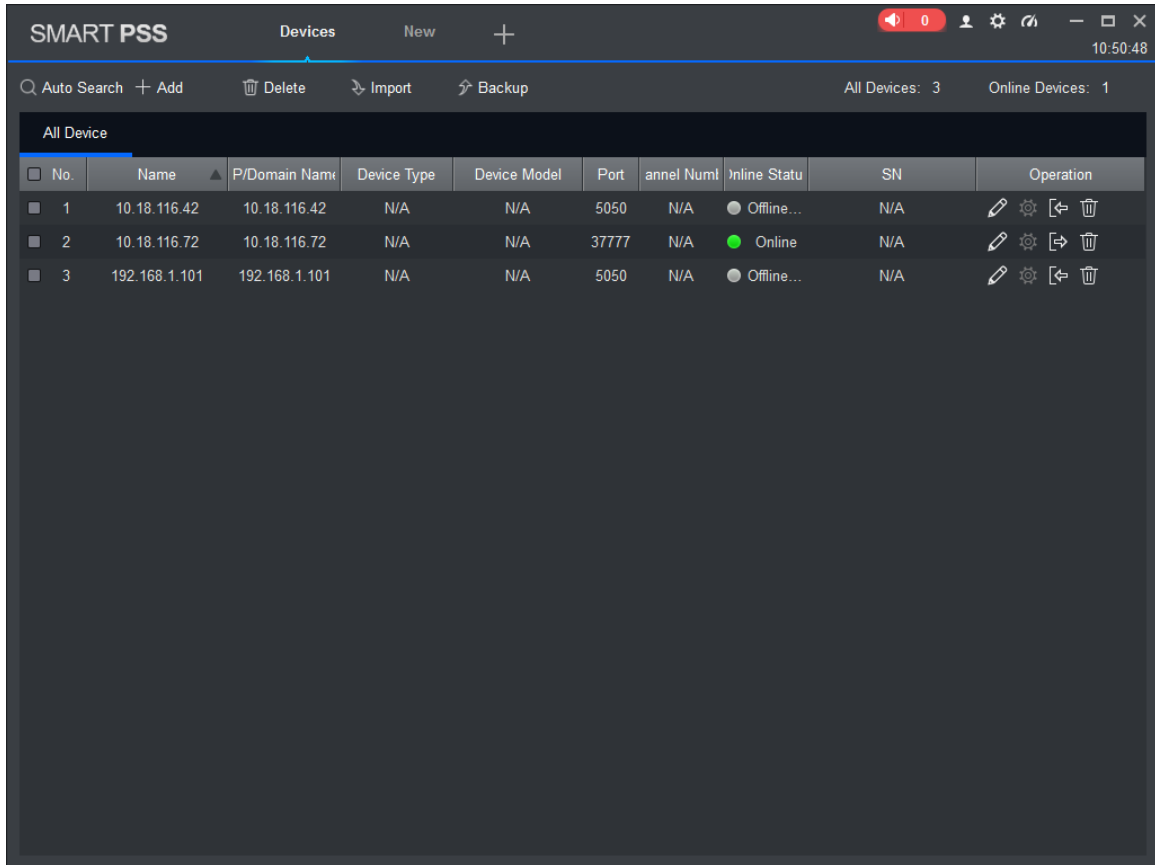

Figure 3-2

Icon	Note
	Click this icon, enter Modify Device interface, you can modify device info, including device name, IP/domain, port, username and password. You can double click device to enter Modify Device interface.
	Click this icon, enter Device Config interface, you can set its camera, network, event, storage and system info.
	<ul style="list-style-type: none"> Device in login status, icon is . Click this icon to exit device, it changes to . Device is offline, icon is . Click this icon, login device (with correct device info), icon changes to .
	Click this icon to delete device.
	When you select to show device code, this icon will be shown. Click this icon to custom device code for future keyboard pairing.

Chart 3-1

3.1.2 Manually Add

When you add a single device, and support device IP and domain name, we recommend you to manually add device.

Step 1

In Devices interface, click Add, see Figure 3-3.

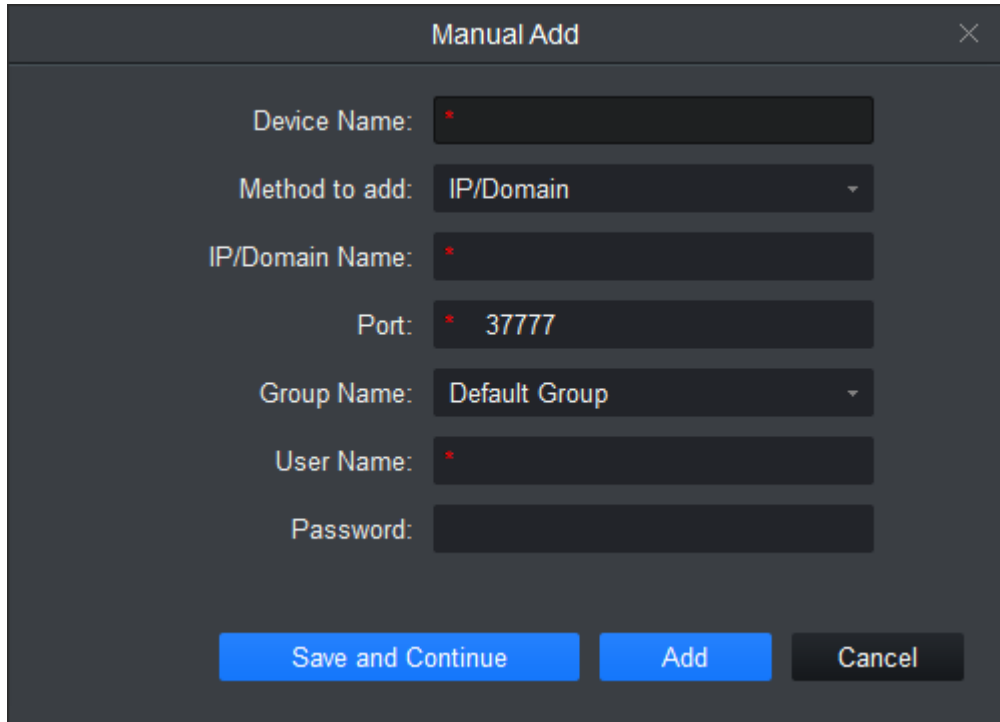

Figure 3-3

Step 2

Set device parameter, see the following chart.

Item	Function
Device name	Please input a device name here.
Method to add	By IP/domain and SN.
IP/Domain name	Device IP address or domain name. Note: You can add device of IPV6 address.
SN	Device SN. Note: For P2P device only.
Port	Device IP port. It is 37777 by default.
Group Name	You can choose one group.

Item	Function
User name	The user name you login the device.
Password	The password you login the device.

Chart 3-2

Step 3

Click Add, complete adding of device.



- If you continue to add device, then click **Save and Continue** to add device and save the manually added device.
- If you cancel adding, then click Cancel to exit.
- After device is added, SmartPSS auto logs in the device. When it successfully logs in, the device status becomes “online”, otherwise it is “offline”.

3.1.3 Batch Import and Add Device

If devices you want to add are not under the same segment, you can prepare device info file (.xml format) and import it into device. If you have management device on www.dahuap2p.com, then you can add device under your account by importing.



If you need a template of device info, you can export it in Device interface.

Step 1

In Devices interface, click Import. See Figure 3-4.

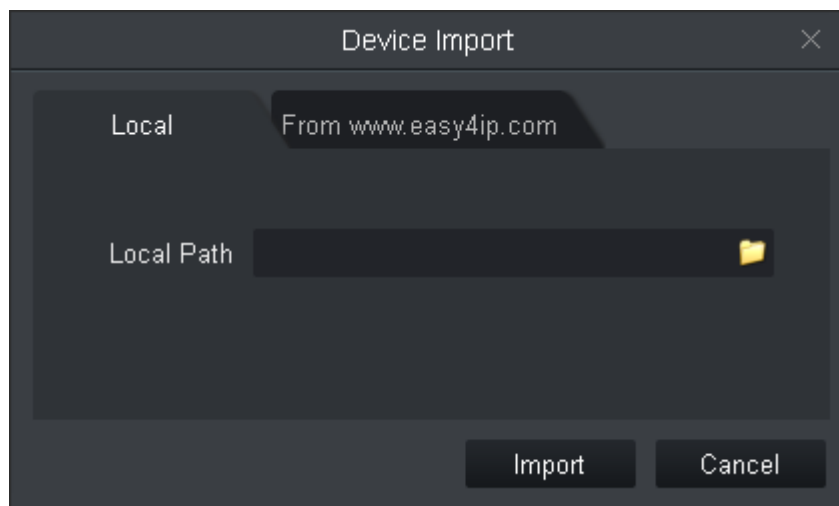

Figure 3-4

Step 2

According to actual condition, select import method.

- Select Local tab to select device info locally.
- Select From www.dahuap2p.com, enter username and password.

Step 3

Click Import. When successfully imported device, system shows a message, click OK.



After device is added, SmartPSS auto logs the device. When it successfully logs in, the device status becomes “online”, otherwise it is “offline”.

3.2 Modify Device Info

Add device info (username, password, IP/domain) which is wrong or shall be updated, you can change info here.



This chapter introduces how to change device info, please refer to 10 Device Config

Step 1

In Device interface, click  next to device you want to modify, or double click device.

See Figure 3-5.

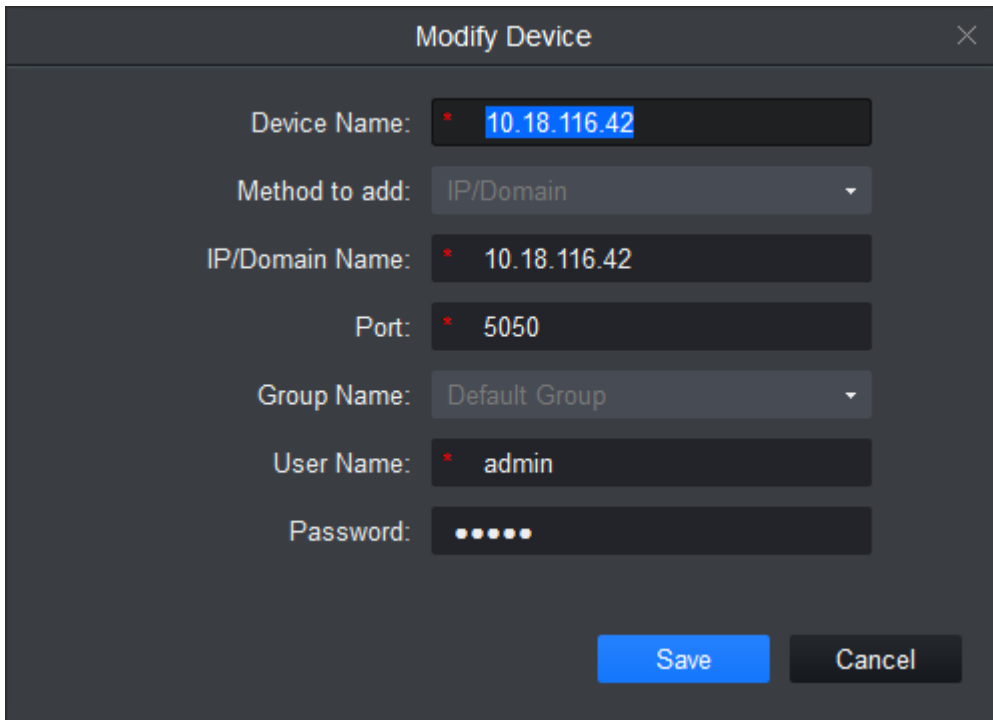

Figure 3-5

Step 2

Change device info, refer to Chart 3-2.

Step 3

Click Save.

3.3 Modify IP Address

Step 1

In Devices interface, click Auto Search.

Step 2

Set device segment and click Search. See Figure 3-6.

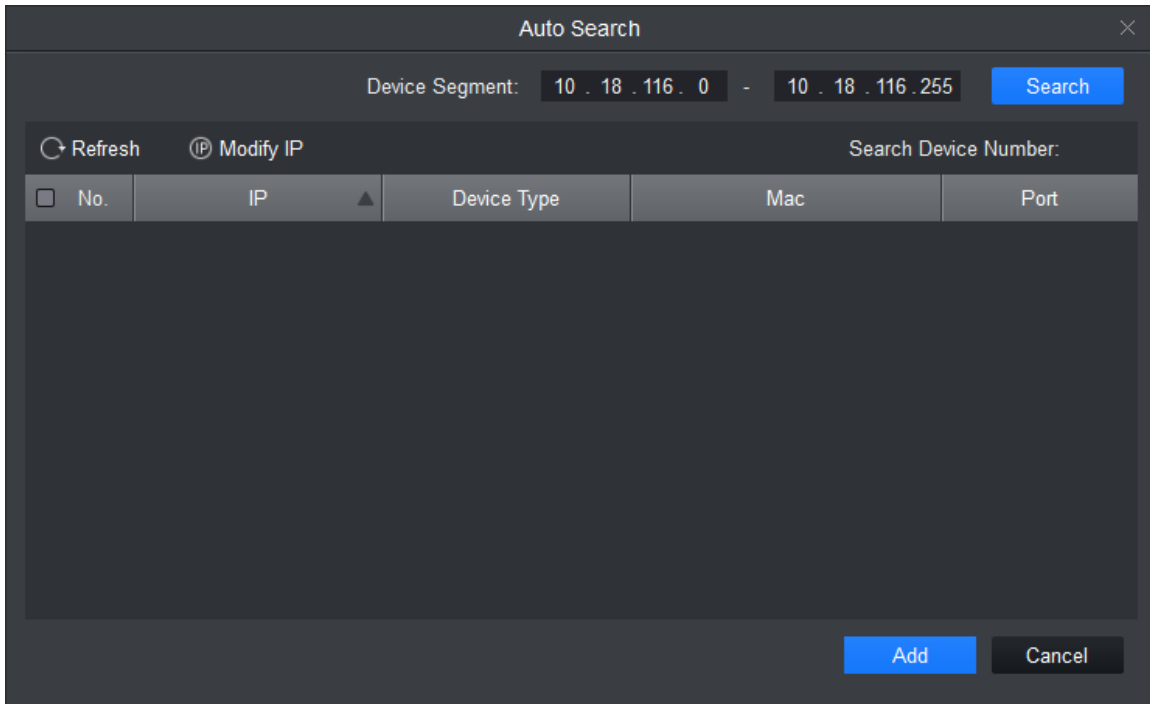

Figure 3-6

Step 3

Check device you want to modify IP, click Modify IP. System pops up modify device IP box.

Step 4

Enter device IP info. Click OK.

- When you check a single device, system pops up Modify IP box, see Figure 3-7.

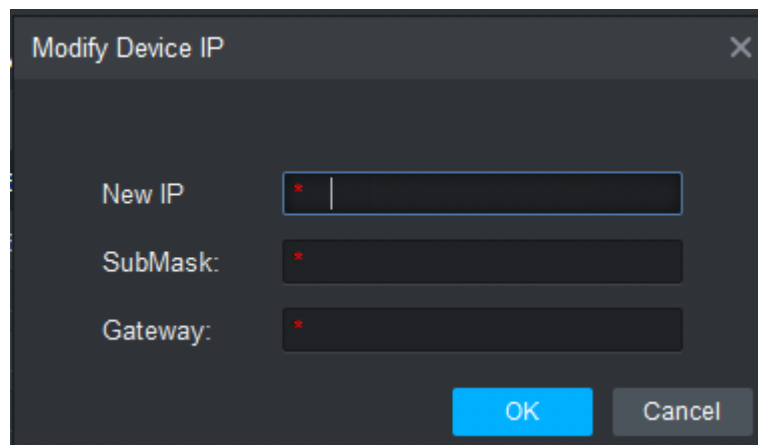

Figure 3-7

- When select more than one device, system pops up Batch Modify IP box, see Figure 3-8.

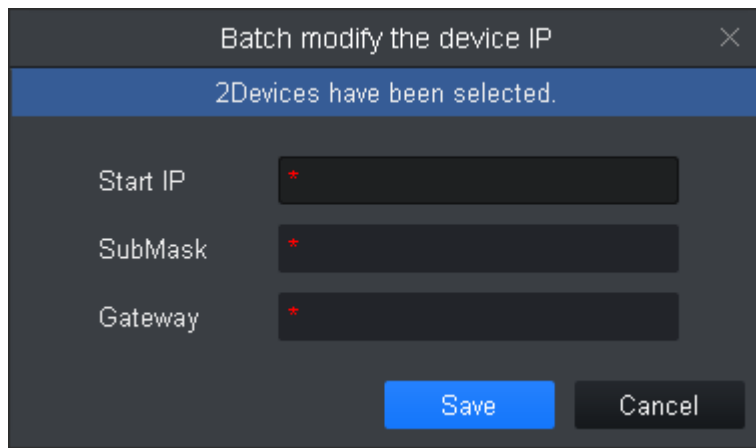

Figure 3-8

Step 5

Set device new IP start IP, subnet mask and gateway.

Step 6

Click Save.

3.4 Delete Device

If device added is no longer managed, please delete the device. You can delete one by one or by batch.

3.4.1 Single Delete

Step 1

In Device interface, click  next to device you want to delete, see Figure 3-9.

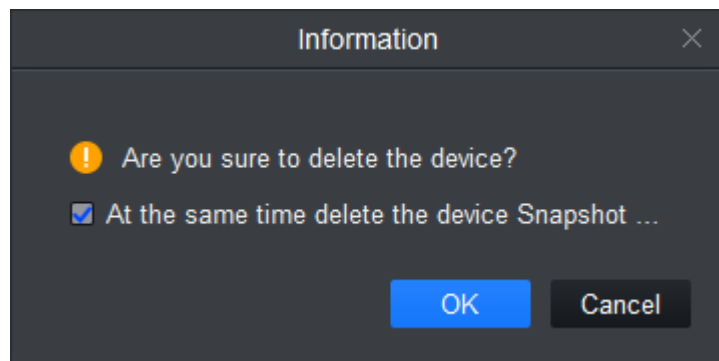

Figure 3-9

Step 2

According to actual condition, check select “at the same time delete the delete snapshot and record” or not.

Step 3

Click OK.

3.4.2 Batch Delete

Step 1

In Device interface, select device to delete.

Step 2

Click Delete. See Figure 3-9.'

Step 3

According to actual condition, check select "at the same time delete the delete snapshot and record" or not.

Step 4

Click OK.

4. Live

After you add device on SmartPSS, you can enter Live View interface to preview. You also can set e-map and etc.

4.1 Introduction to Interface

The following introduce each part and function of interface.

Click , in **New** interface select **Live View**, see Figure 4-1.

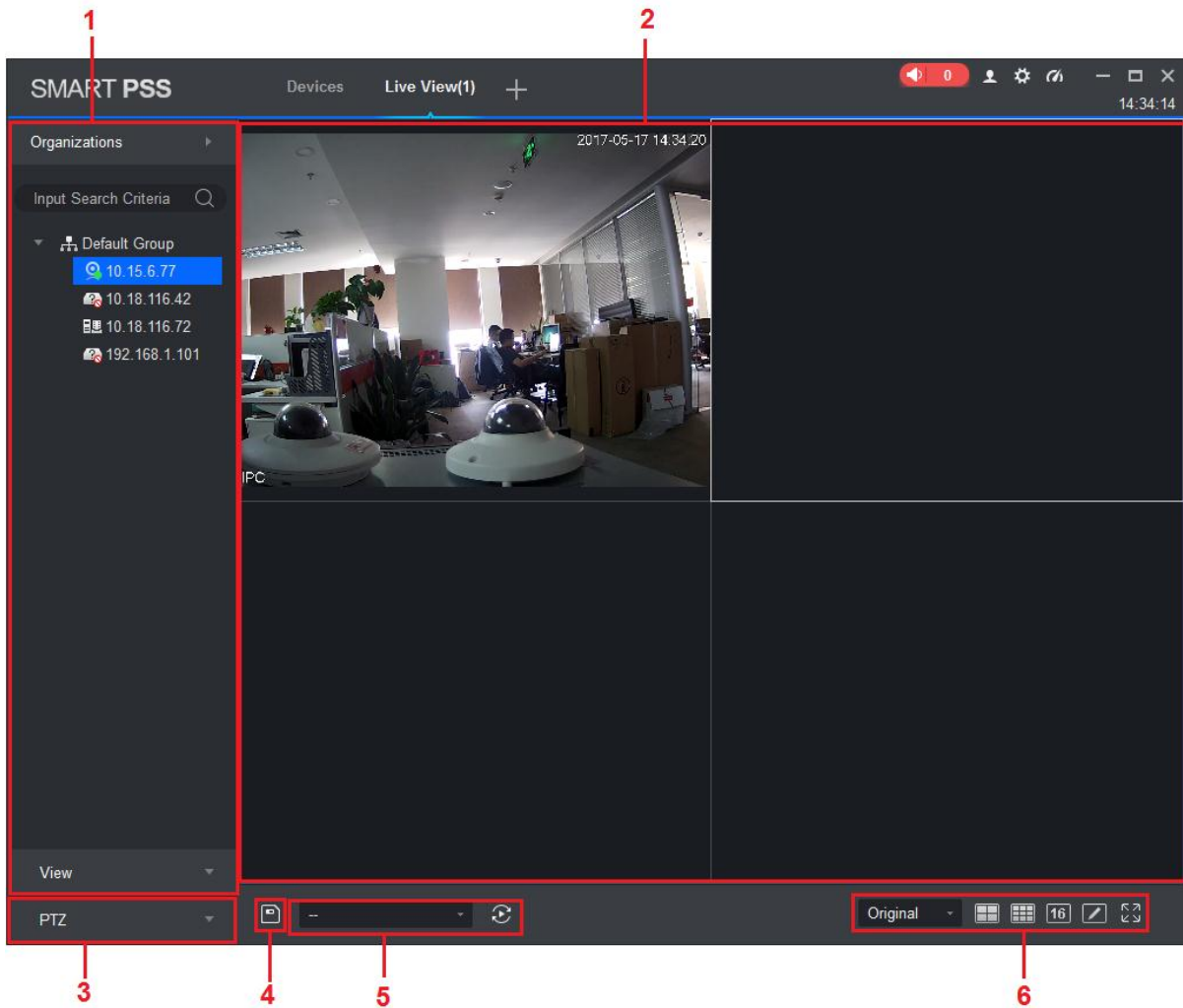

Figure 4-1

No.	Name	Note
1	Device list	<p>You can switch streams, create device groups, create new maps, update channel information, modify channel names, log off, and log in to devices.</p> <ul style="list-style-type: none"> ● When the Default Device Tree is set to Device Tree (by device), the device tree displays the grouping and channels for the device. ● When the Default Device Tree is set to Area Tree (by channel), the device tree displays the zones and channels. <p>Here makes organization tree as an example. Area tree is same with organization tree.</p> <p>Device list supports to manage device (rename and delete group), switch stream, create map, enter device config, master-slave config, intelligent default and etc.</p> <p>Steps:</p> <ul style="list-style-type: none"> ● Right click in space area, you can create group, same level with default group. ● Right click to create group (create group under selected group), rename group, select stream (apply to all channels in group), create map. ● Right click one channel (device is online), and you can switch stream, enable alarm output, update channel info, enter device config, intelligent default, master-slave config interface, log out. ● Right click channel (device is offline), log in device.
2	Preview Window	Browse this area; window can be split into various modes. You can snapshot, record during preview. It supports tour, talk, IVS overlay and etc., refer to 4.2 Live View
3	PTZ	<ul style="list-style-type: none"> ● For motorized zoom devices, focus, autofocus, or focus can be reset. ● For PTZ setting, you can simulate the mouse, open or close PTZ menu; adjust PTZ speed, direction, zoom, focus and iris. <p>Click More Features to set Preset, Tour, Horizontal Rotation, Scan, Track, and Accessibility. See 4.8 PTZ</p>
4	Save View	<p>When there are many devices connected, and you often preview more than once window at the same time, you can save preview as view of multiple devices, so when you enable this view in the future, it will auto open device preview saved.</p> <p>Saved views are shown below view tab under device list, and can be added to tour plan and the same time.</p>
5	Tour	When tour plan exists, you can select tour quickly here.
6	Aspect Ratio and Window Split	 <p>adjust adpest ratio</p> <p>adjust split</p>

Chart 4-1

4.2 Live View

You can live view video, local record, snapshot, enable audio, talk, instant playback, zoom in video, switch stream, config device parameter, config intelligent channel, config master-slave track, update channel info and etc.

4.2.1 Start Live

You can preview via:

- Select preview window, double click to preview in device list.
- Drag device you want to preview into window.

See Figure 4-2.

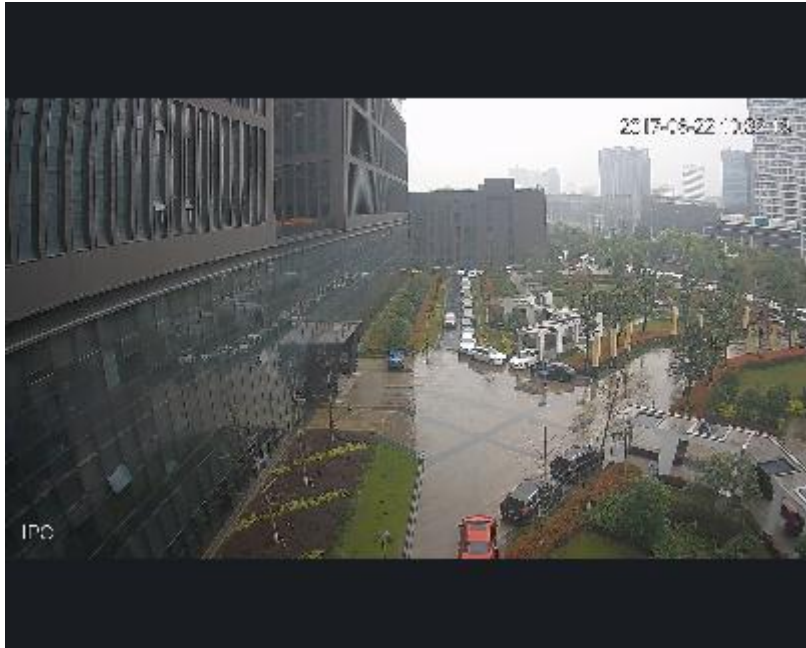











Figure 4-2

4.2.2 Live Operation

No.	Task	Note	Operation
1	Open record local	Save record to local	Select open video window which is ON, and click  or right click to select Start Record. Note: You can modify the saved path in System Configuration> File Settings.
2	Snapshot	Manually snapshot	Select open video window which is ON, and click  or right-click to select Snapshot, snapshot a single picture. Note: You can change the path where the image is saved in System Configuration> File Settings.
3	Triple Snapshot	Snapshot three pictures at once	Select the preview video window, right click Triple Snapshot, the system continuously snapshot three pictures.
4	Start audio	Start audio to get audio message sent to device	Select open video window which is ON, and click  or right-click to select Start Audio.
5	Talk	Talk to connected device	Select open video window which is ON, and click  or right-click to select Start Talk, you can talk between the client and the device.
6	Turn on the remote intercom	When you preview the channel under the storage device, and the device supports remote channel intercom, select the video window with preview opened, right-click to select Turn on the remote intercom, the remote channel on the client and the storage device can be speak.	Select open preview window, right click to select remote intercom.

No.	Task	Note	Operation
7	Start instant playback	Playback record 1-60 min prior of current channel	Select open video window which is ON, and click  or right-click to select Start Instant Playback.
8	Zoom in	Select area to zoom in	Select open video window which is ON, and click  .
9	Close window	N/A	Select open video window which is ON, and click  or right click to select Close Window.
10	Close windows all	N/A	Select the video window, right-click to select Close All Windows.
11	Playback	Playback record video.	Select the preview video window, right-click Playback to enter the Playback interface. See 6 Playback
12	Fisheye installation	For fisheye device only. Fisheye installation mode includes  (Ceiling),  (Wall mount) and  (GND).	Select the video window with preview ON, right click on Fisheye Installation Mode and select the installation mode according to the actual installation of the device.
13	Fisheye view mode	For fisheye device only. The view mode is different depending on the installation mode of the fisheye. See 4.9 Fisheye View Mode	Select the preview video window, right-click the Fisheye view mode, according to the actual situation to select the desired view mode.
14	Split screen tracking	Split screen tracking includes the normal mode, 1 +3 mode and 1 +5 mode three modes. <ul style="list-style-type: none"> ● Normal mode: Original image. ● 1+ 3 mode: the original image and 3 sub-window, the original image can be adjusted 3 sub-window position. ● 1 + 5 mode: the original image and 5 sub-window, the original image can be adjusted 5 sub-window position. 	Select enabled preview window, right click split screen tracking, and select split.
15	Adjust	It is used to adjust the preview effect of the video screen on the client and does not change the actual image parameters of the device. You can adjust the brightness, contrast, saturation and hue of the video screen.	<ol style="list-style-type: none"> 1. Select open preview window, right click select image adjust. 2. Adjust image, click exit.
16	Smart overlay	Make intelligent rules or intelligent object box displayed in the video screen.	Select the video window with the preview turned on, right-click on the Intelligent overlay> Intelligent rule or Intelligent object box.

No.	Task	Note	Operation
17	Set video scale	Adjust aspect ratio of video.	Select the video window, right-click to select Window Scale, select the video screen display ratio.
18	Switch play strategy	Play strategy includes balance, real-time and fluency.	Select enabled video window, right click window and select play strategy.
19	Switch stream	Support main stream, sub stream1 and sub stream 2.	Select enabled video window, right click stream type.
20	Full screen	Supports full screen display of live window.	Right click Full Screen on the live window.
21	Enable People Density picture	Display people density info on the overlay picture-in-picture at the live interface. Double click overlay picture-in-picture to hide it and blue dot appears on the personnel in the image.	Select the panoramic + PTZ video window which enabled live, right click and select Enable People Density Picture .

Chart 4-2

4.2.3 Adjust Monitor Window Number

Click , to adjust window number. The first three icons are commonly used for favorites, and the fourth window is custom window plus the fifth window is full screen.

- Favorites common windows

Click , in standard interface, you can select window split number. You may add number of split up to 3 favorites. When you see a star marked at upper right corner, it means favorite is successfully added. See Figure 4-3.

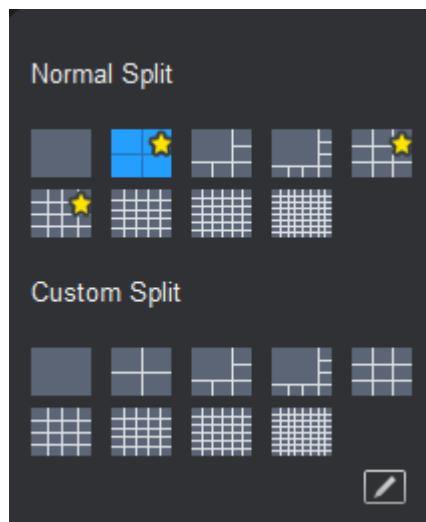

Figure 4-3

- Customize window split.

1. Click . See Figure 4-4.

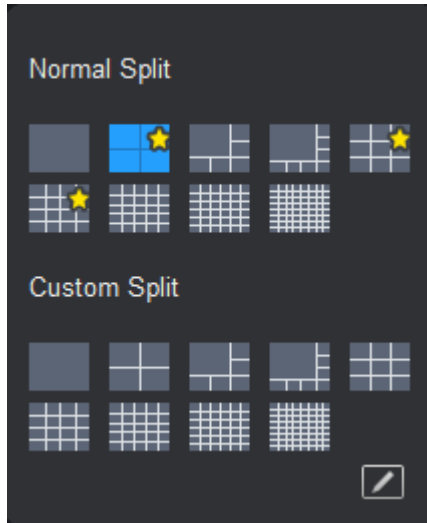



Figure 4-4

2. Customize window number.

- In custom area, there are 9 splits. Click icon to split into corresponding number of windows.
- If you want to split window again, click  to set, see Figure 4-5.

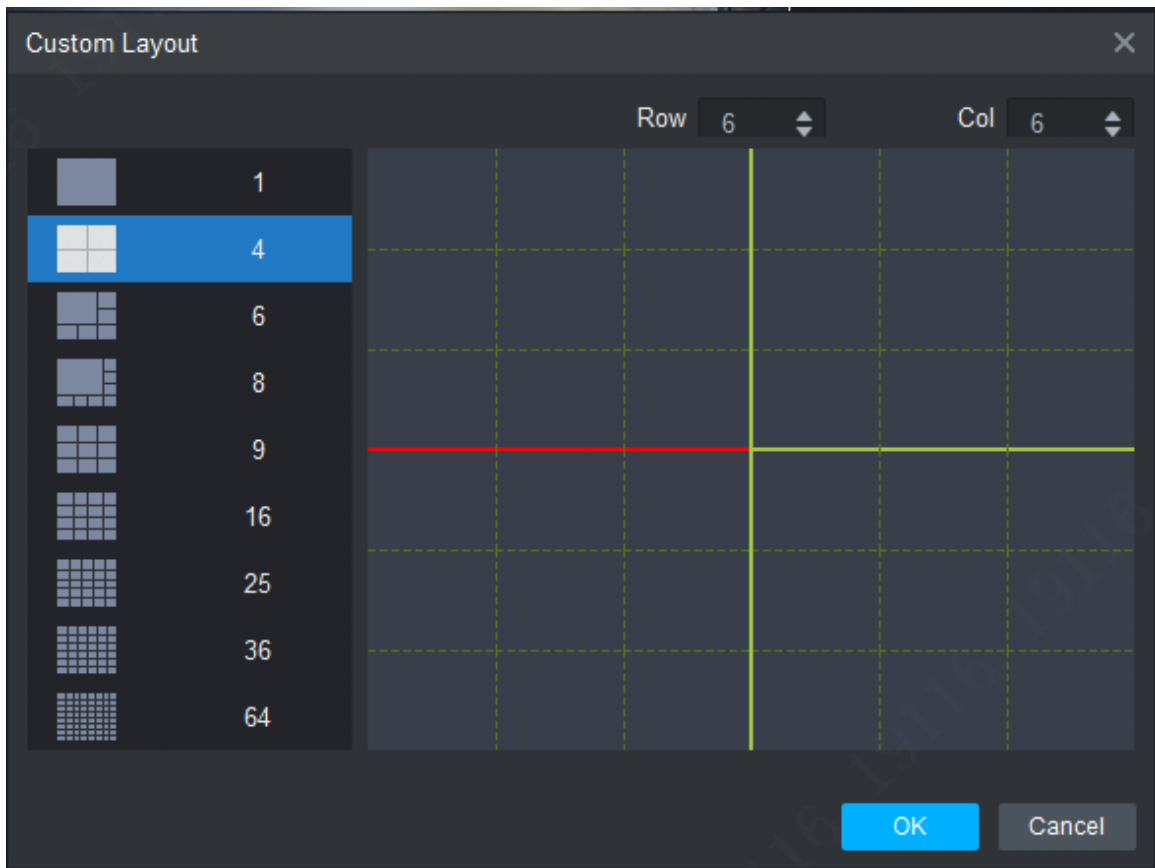

Figure 4-5

4.3 E-Map

Via E-map you can straightly know the location of video channel or alarm channel and live preview.

4.3.1 New Map

Step 1

Right click group in Organization Tree, select New Map. See Figure 4-6.

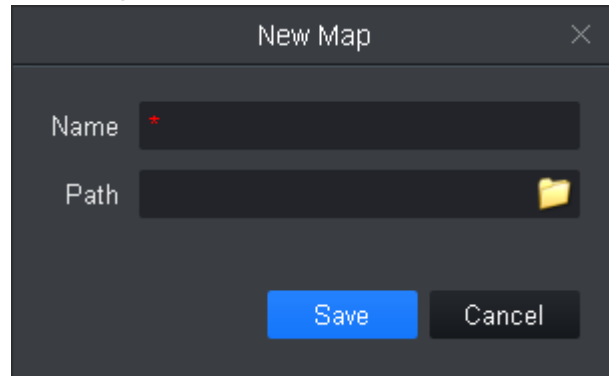

Figure 4-6

Step 2

Set map name, select path of picture.

Step 3

Click Save. See Figure 4-7.

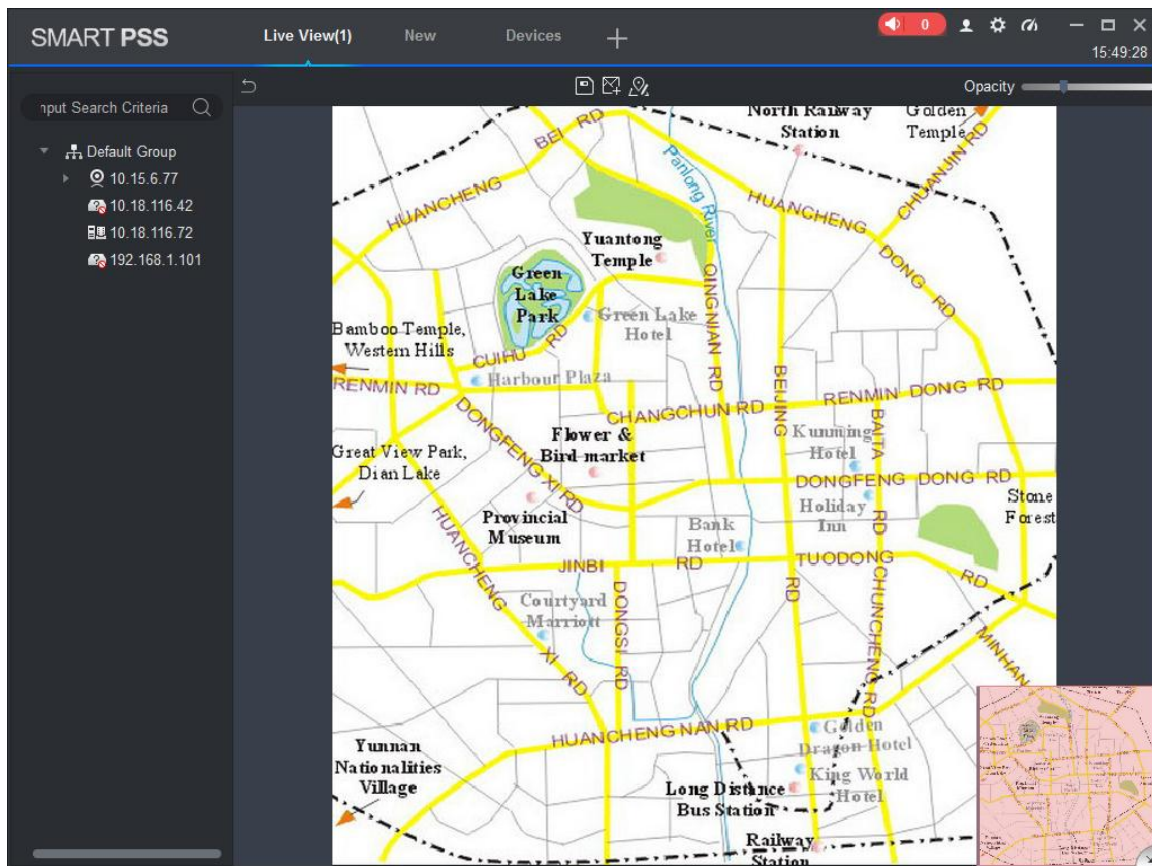







Figure 4-7



- Click , create new hot zone on map.
- Click , modify map name or replace map.
- Click  to adjust opacity.
- Click  and exit config interface of E-map.
- At the lower right corner, you can see aerial view of map. Click , to close aerial view and click  to open aerial view.

Step 4

Drag camera to corresponding monitor position on map to adjust camera monitor range, or drag camera alarm input into map. See Figure 4-8.

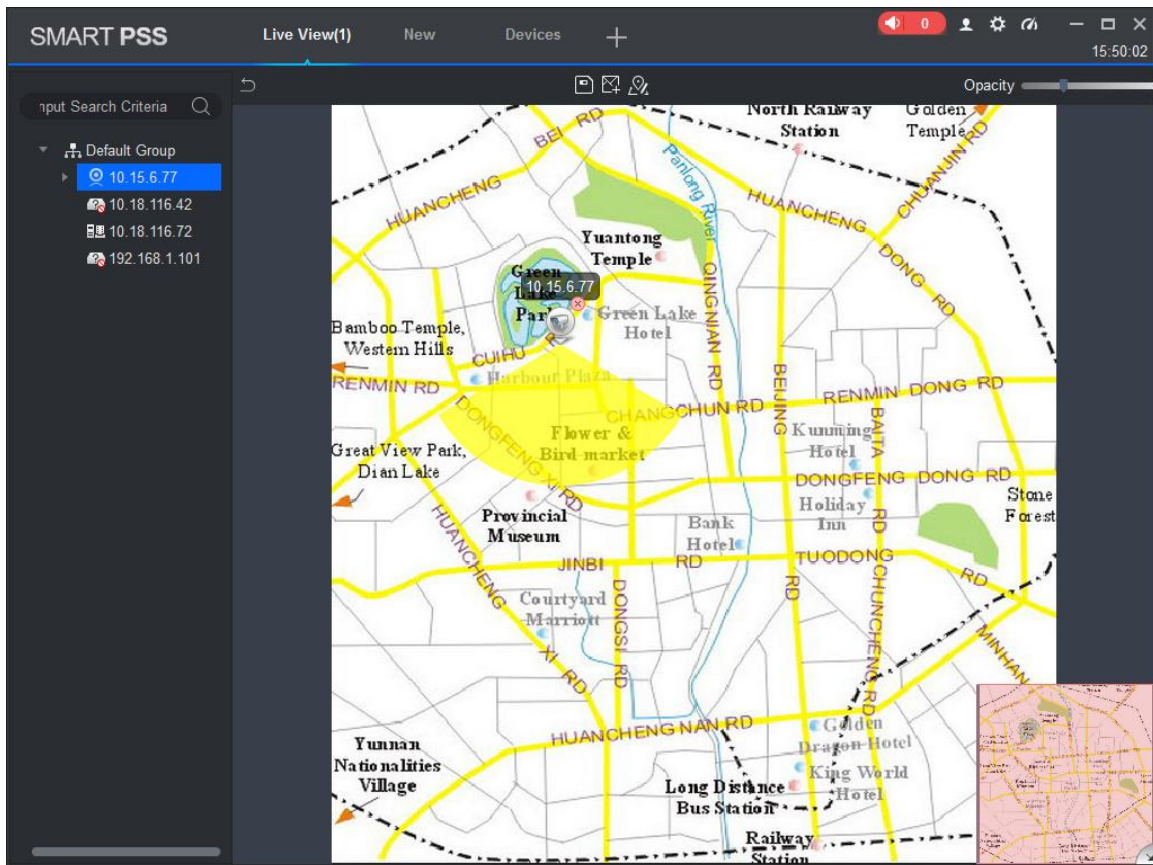



Figure 4-8

Step 5

Add new hot zone.

3. In e-map interface, click . See Figure 4-9.

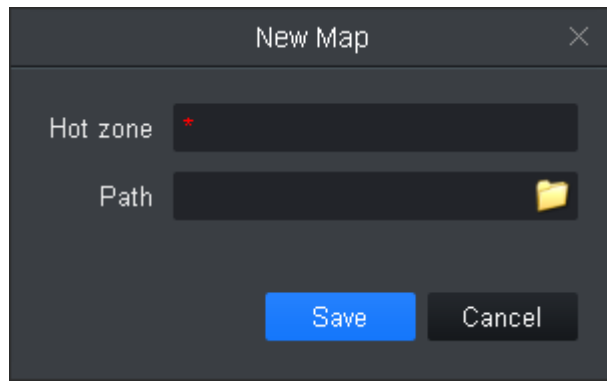

Figure 4-9

4. Set map name, select picture path. Click Save.
5. Double click hot zone, map switch to hot zone map, see Figure 4-10.

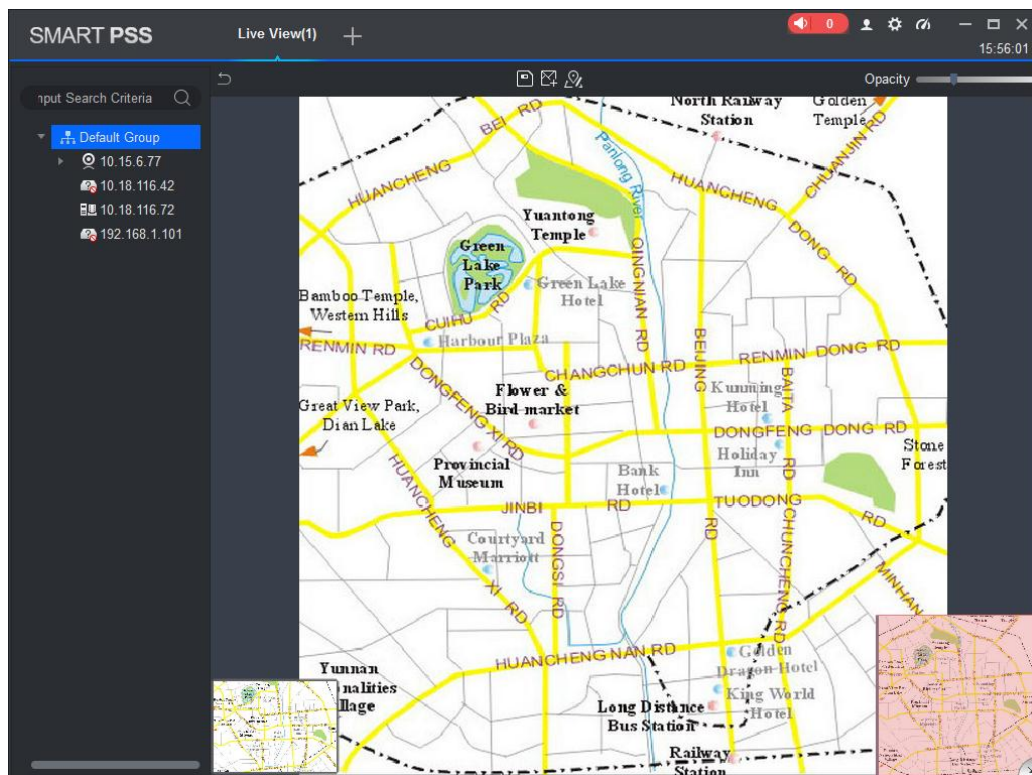

Figure 4-10



On map, click picture window at the lower-left corner, you can return to map or previous level of hot zone.

6. Drag device in list to map, and adjust camera monitoring range.

Step 6



Click  to save map. After config is complete, it shows created map and hot zone in it, see Figure 4-11.

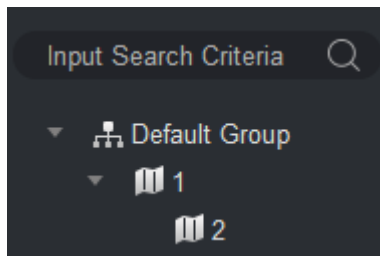

Figure 4-11

4.3.2 Preview Map or Hot Zone

It supports to add camera on map or hot zone, and here uses hot zone as an example.

Step 1

Open **Live** interface, in device list double click heat map or drag heat map into preview window.

Step 2

On map click camera or place mouse on camera for a few seconds, in the pop-up window you can view live preview.





- In hot zone preview window, click  to return to map preview.
- If current preview is map, double click hot zone mark on it to enter hot zone.
- Click hot zone preview window, right click and select Open All Channels, at bottom of preview window it shows live of all devices.
- Right click Video Wall, and in pop-up window it shows live of all devices.

4.4 Config IVS Channel

IVS includes general behavior analytics; face recognition, people count, heat map and etc., different devices support different IVS plans, which subject to actual interface.

In Live View interface, right click device in list, select IVS channel config, see Figure 4-12.



- IVS analytics only detects IVS analytics capacity of connected device.
- Speed dome or PTZ device support scene config and preset selection, IPC do not support scene config.
- Set IVS analytics refer to continuous setup in this chapter.
- If you need a static scene, you can click  to stop video; click  to continue playing.

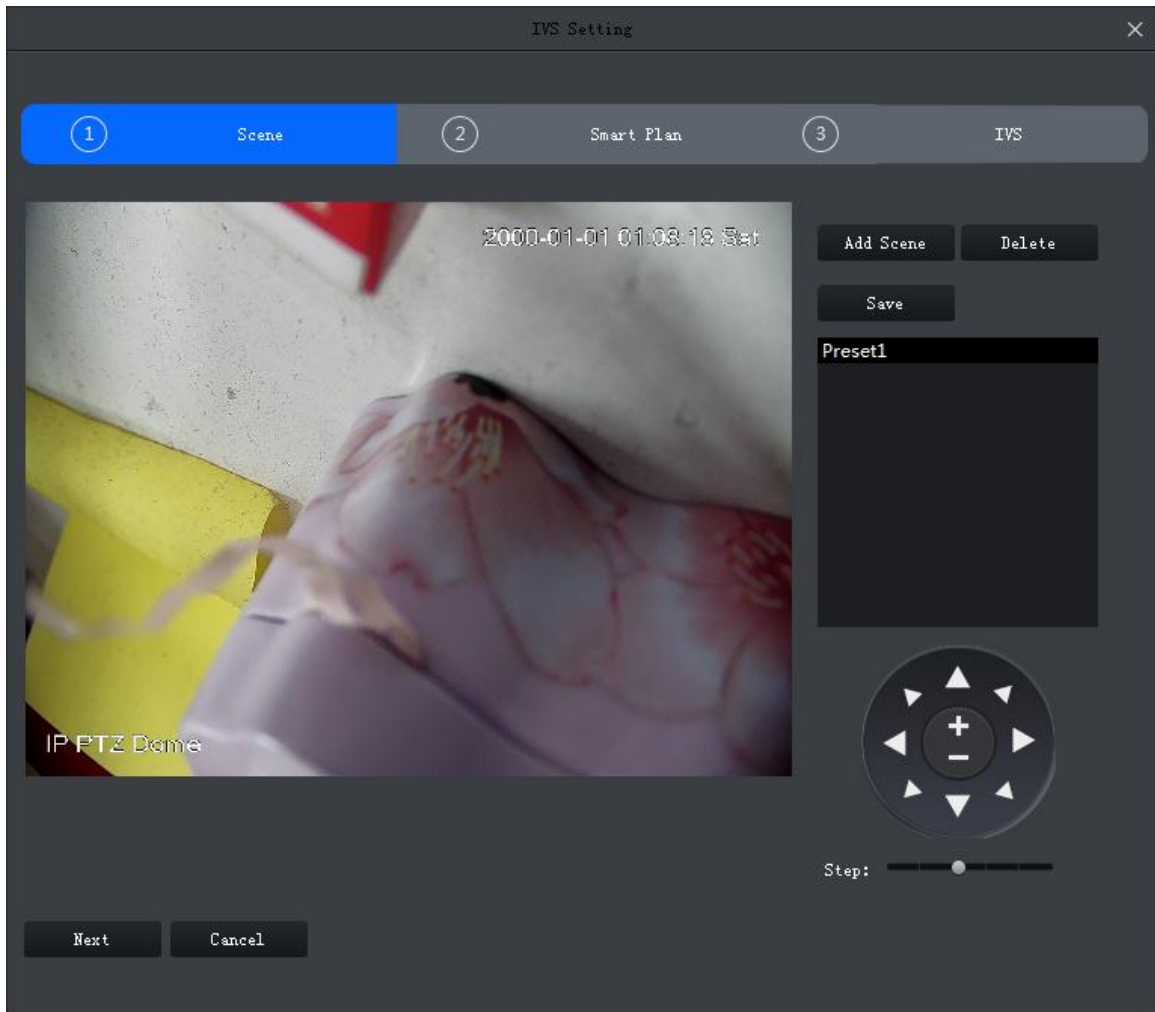

Figure 4-12

4.4.1 Scene Config

For example to device to add is speed dome or PTZ device, then it supports to set preset in scene config interface, and you can set different plans for preset.

Add Preset

Step 1

In Scene interface, click Add Scene, see Figure 4-13.

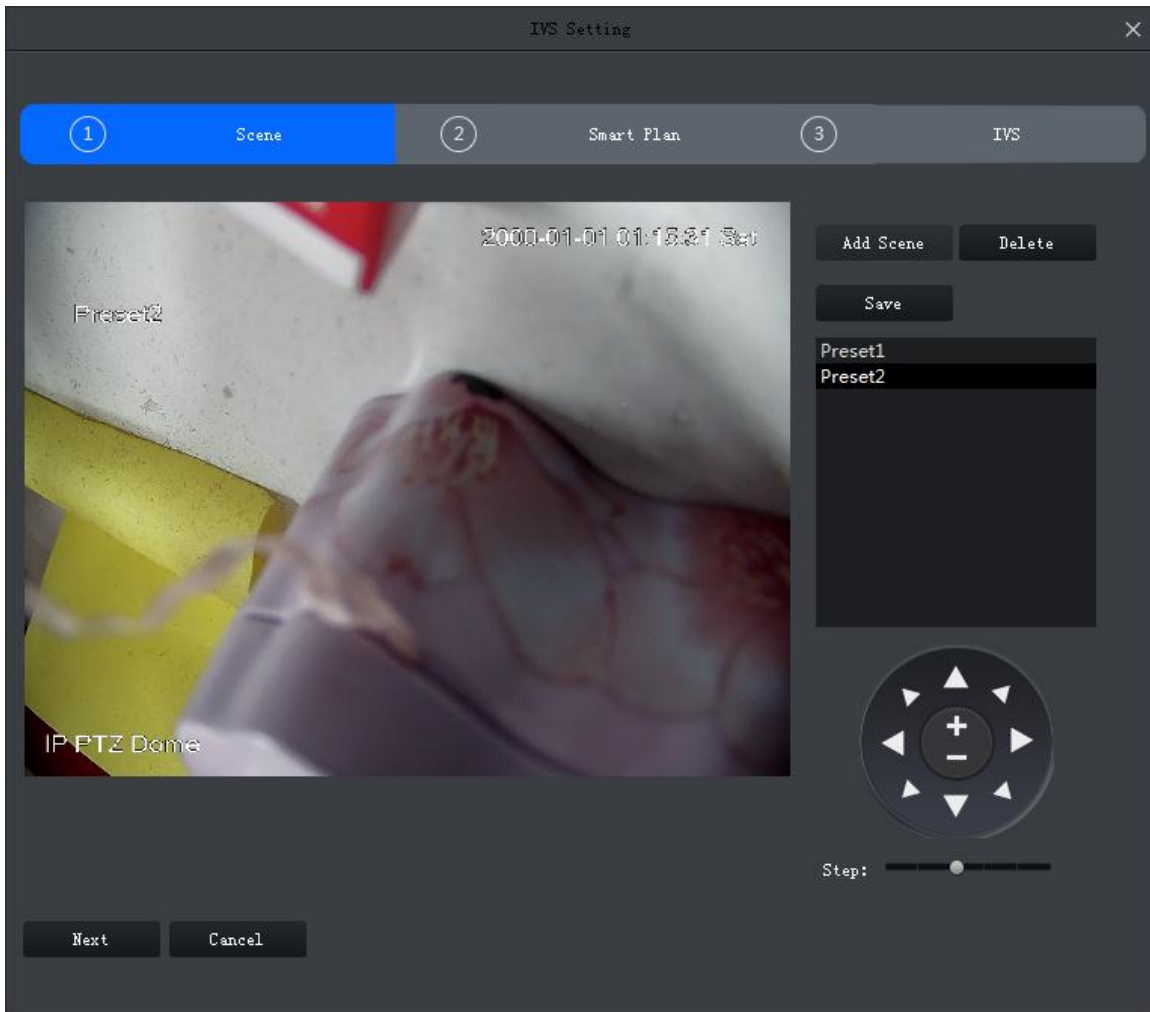

Figure 4-13

Step 2

Via PTZ direction control, rotate camera to designated position.



Step length can control PTZ speed, within 1~8 step length.

Step 3

Click Save.

Modify Preset

Step 1

In Scene interface, select preset to modify, see Figure 4-13.

Step 2

Via PTZ direction control, rotate camera to designated position.



Step length can control PTZ speed, within 1~8 step length.

Step 3

Click Save.

Delete Preset

Step 1

In Scene interface, select preset to delete, see Figure 4-13.

Step 2

Click Delete.

4.4.2 General Behavior Analytics

After you enable behavior analytics, you can tripwire, perimeter protection and etc. Refer to actual front-end device.

4.4.2.1 Enable Behavior Analytics

Step 1

In Scene interface, when preset setup is complete, click Next. See Figure 4-14.

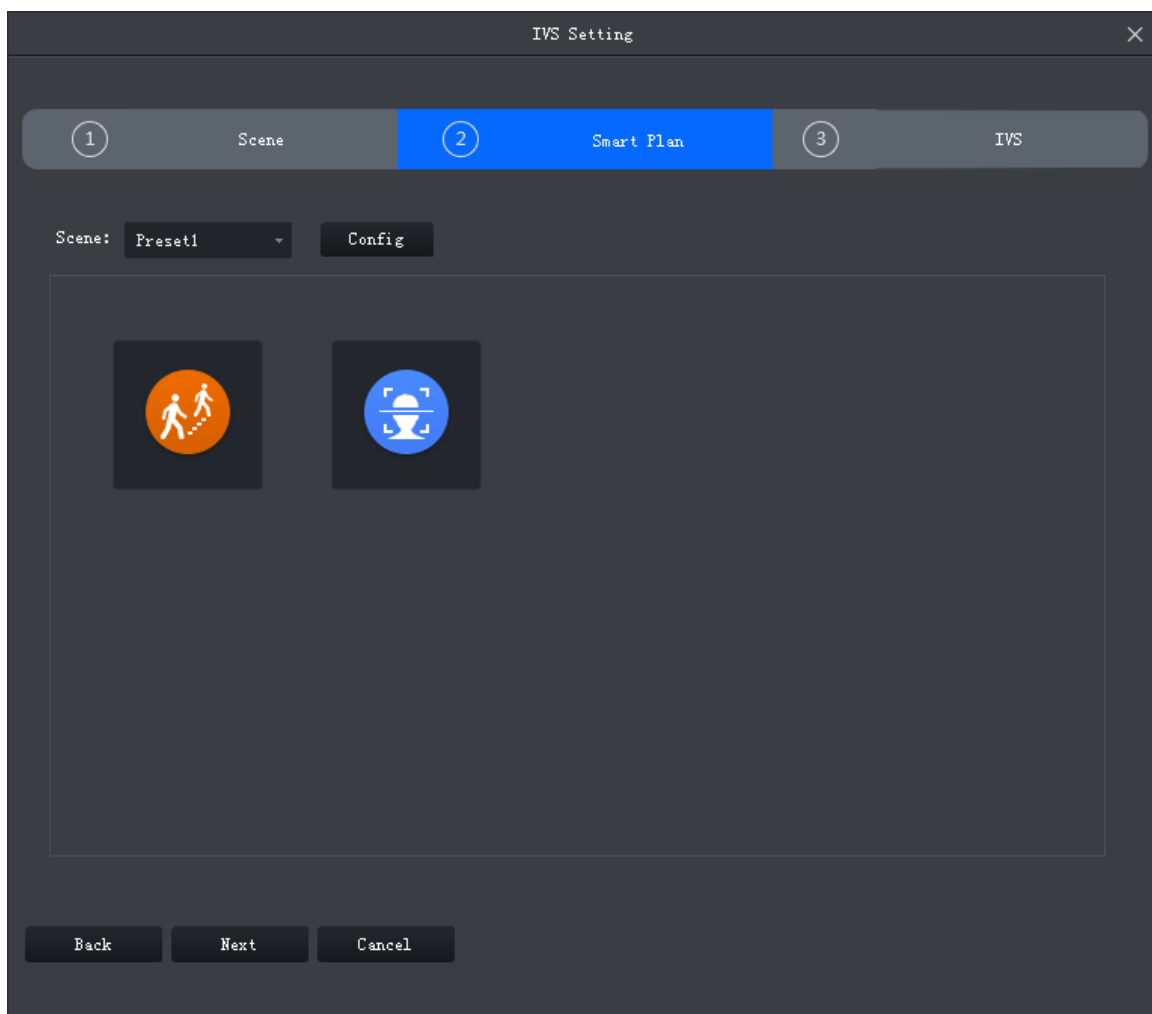



Figure 4-14

Step 2

Select scene.

Step 3

Click  and select IVS plan.

4.4.2.2 Calibration

According to user marked 1 horizontal line and 3 vertical lines, and corresponding actual distance, it can estimate internal parameter and external parameter in order to confirm relationship between gotten 2D image and 3D actual object.

Step 1

In Smart Plan interface select plan and click **Next** or config, see Figure 4-15.

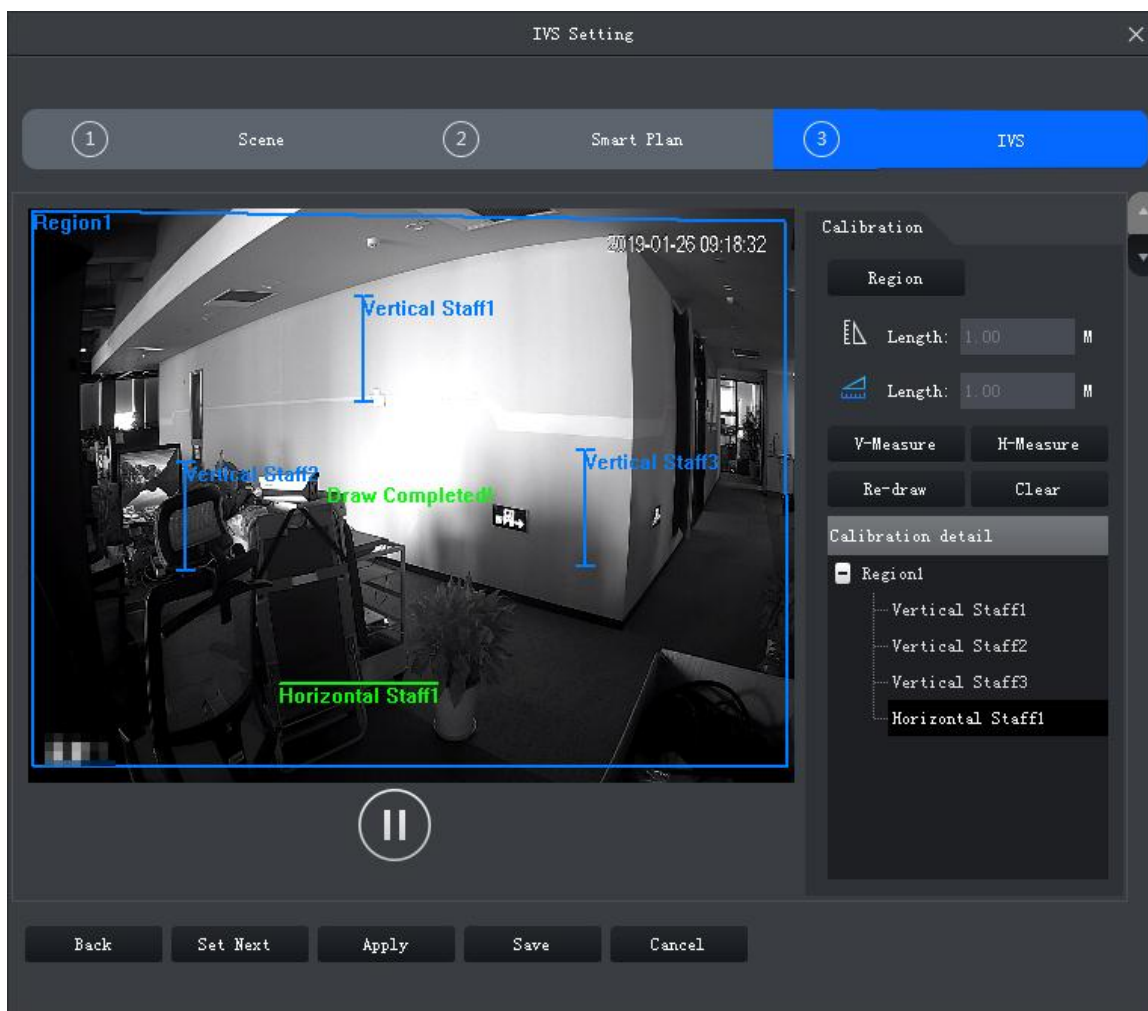

Figure 4-15

Step 2

Click Region, and draw region in window, when you complete, right click to end.

Step 3

Set ruler length, click , Draw vertical rule and left click to end drawing.

Repeat this step to draw 3 vertical rulers. Shape of triangle is recommended.

Step 4

Set horizontal rule angle, click , and draw 1 horizontal line in region, left click to end.



- Select vertical or horizontal rule, click redraw to draw rule. Select region, click redraw is you want to draw again region, vertical ruler and horizontal ruler.
- Select vertical or horizontal ruler, click Delete to delete ruler. Select region, click **Delete** to delete region, vertical ruler and horizontal ruler together.

Step 5

Click Apply to save.

Step 6

(Optional) vertically or horizontally measure distance.

- Click V-measure, and draw vertical line in region, system shows all drawn vertical line length.
- Click H-measure, and draw horizontal line in region, system shows all drawn horizontal line length.

4.4.2.3 Set Detection Zone

You can set region of IVS analysis.

Step 1

Click . See Figure 4-16.

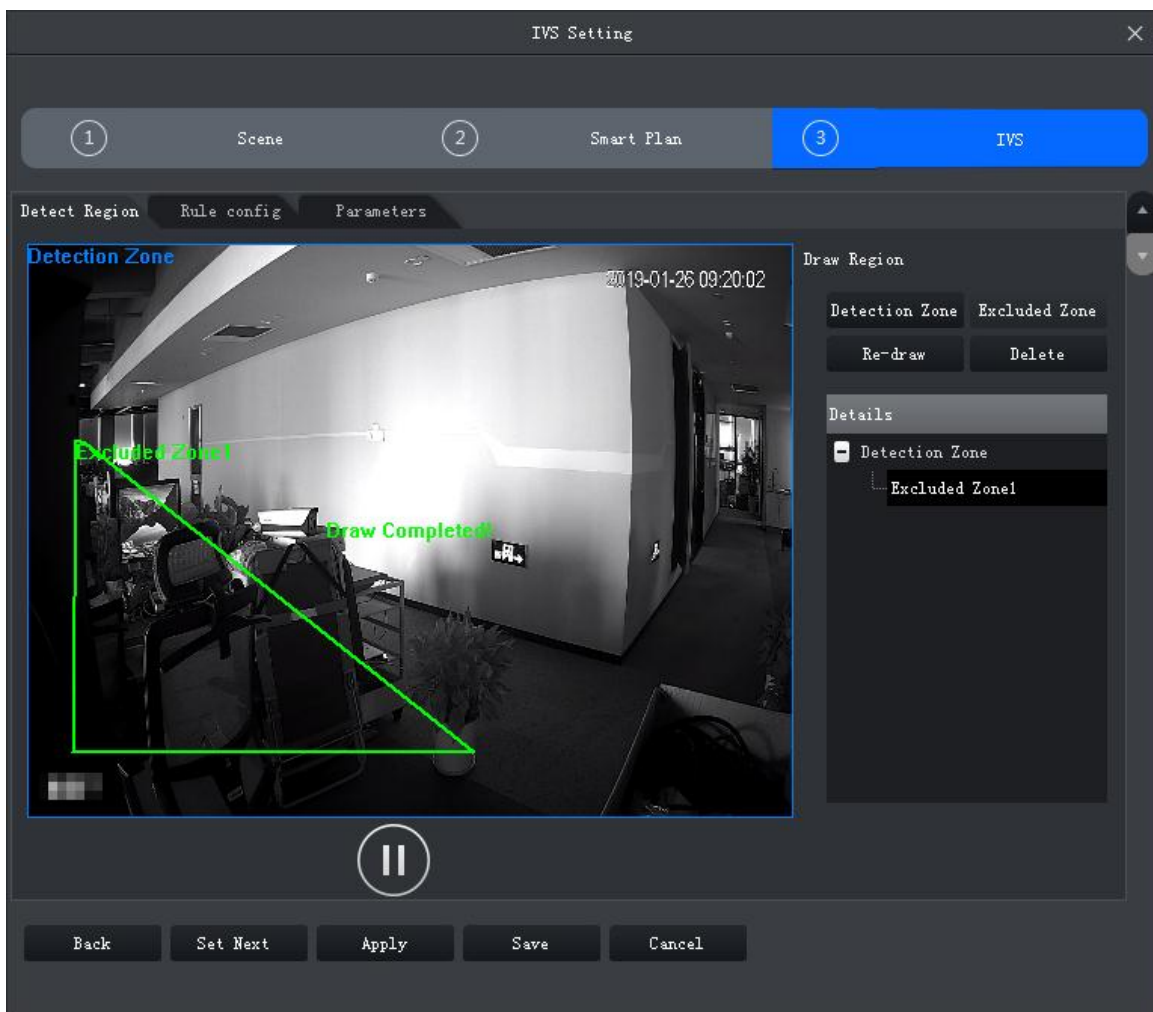

Figure 4-16

Step 2

Click Detection Zone, in video window, draw detection zone and right click to stop drawing.

Step 3

Click Excluded Zone, in detection zone draw excluded zone, and right click to stop drawing.



- Select excluded zone, click Re-draw to draw again. Selected detection, click Re-draw to redraw detection and excluded zone.
- Select excluded zone, click Delete to delete zone. Selected detection, click Delete to delete detection and excluded zone.

4.4.2.4 IVS Rule

Here you can set IVS rule.

In Smart Plan interface, select Next or config, see Figure 4-17.

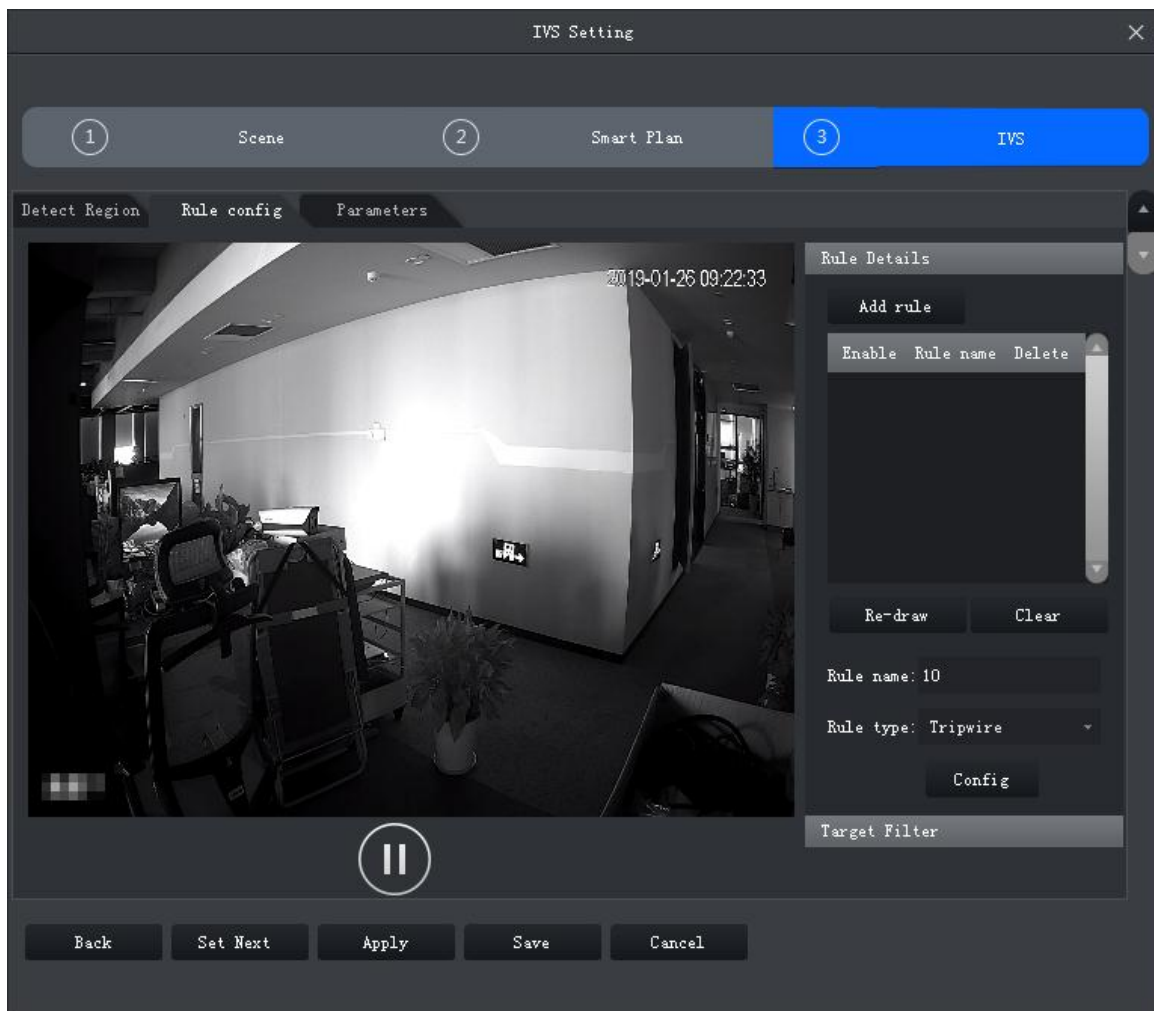

Figure 4-17

4.4.2.4.1 Crossing Virtual Fence

When a target crosses upper and lower fences, alarm is triggered.

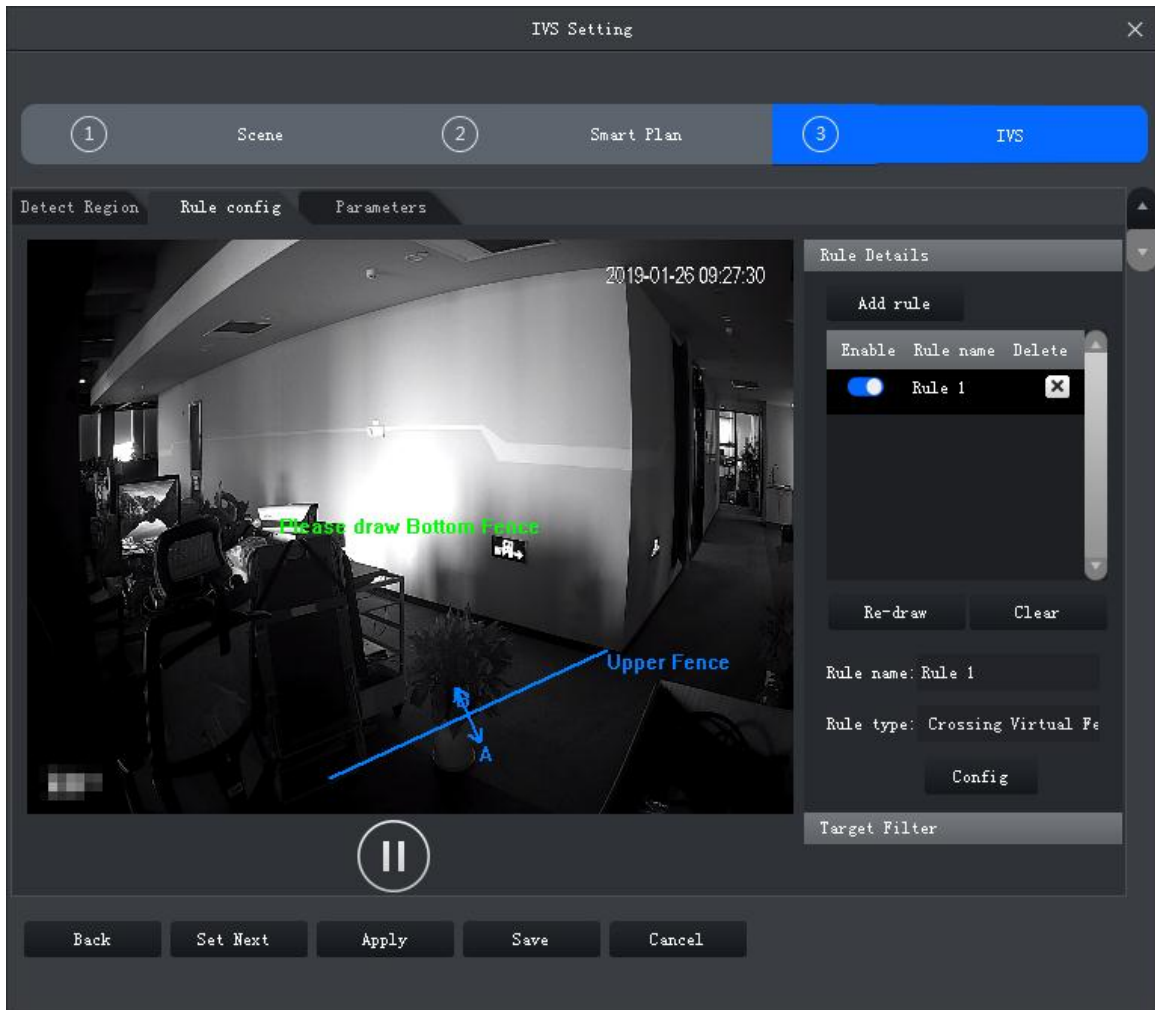



Figure 4-18

Step 1

Click Add rule.

Step 2

Enable rule and modify rule name and type.

1. Enable rule,  means to enable corresponding IVS rule.
2. Modify rule name.
3. In Rule type dropdown list, select **Crossing Virtual Fence**.

Step 3

In monitoring video, draw fence, and right click to stop drawing.



- In drawing status, click Clear to delete existing fence.
- Select upper or lower fence, click Re-draw to draw again.

Step 4

Set parameter, arm time and alarm link.

1. Click Config, set parameter, see Figure 4-19. See Chart 4-3.

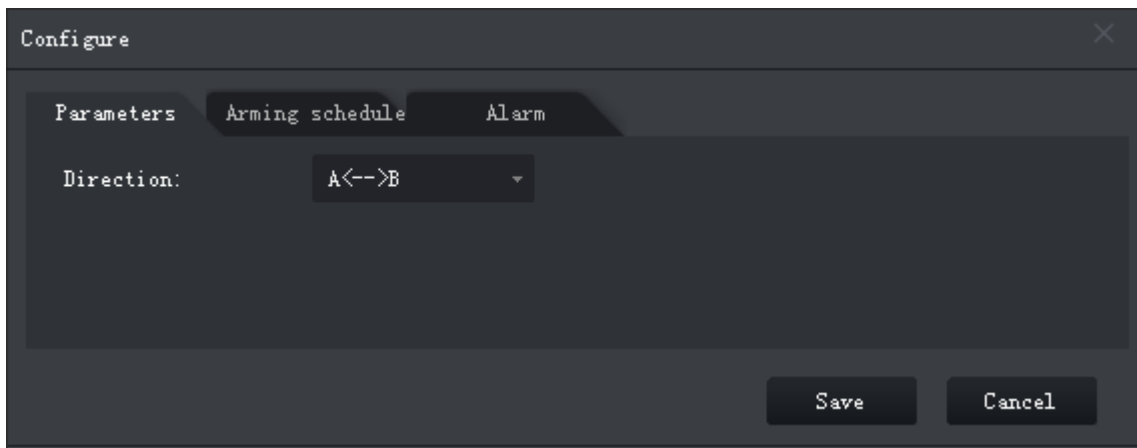

Figure 4-19

Parameter	Note
Direction	Movement of target and setup direction are the same, as intrusion. It supports setup direction of A→B, B→A, A↔B.

Chart 4-3

2. Click Arming Schedule, select week and period, enter start time and end time. See Figure 4-20.



Default is 24-hour every day.

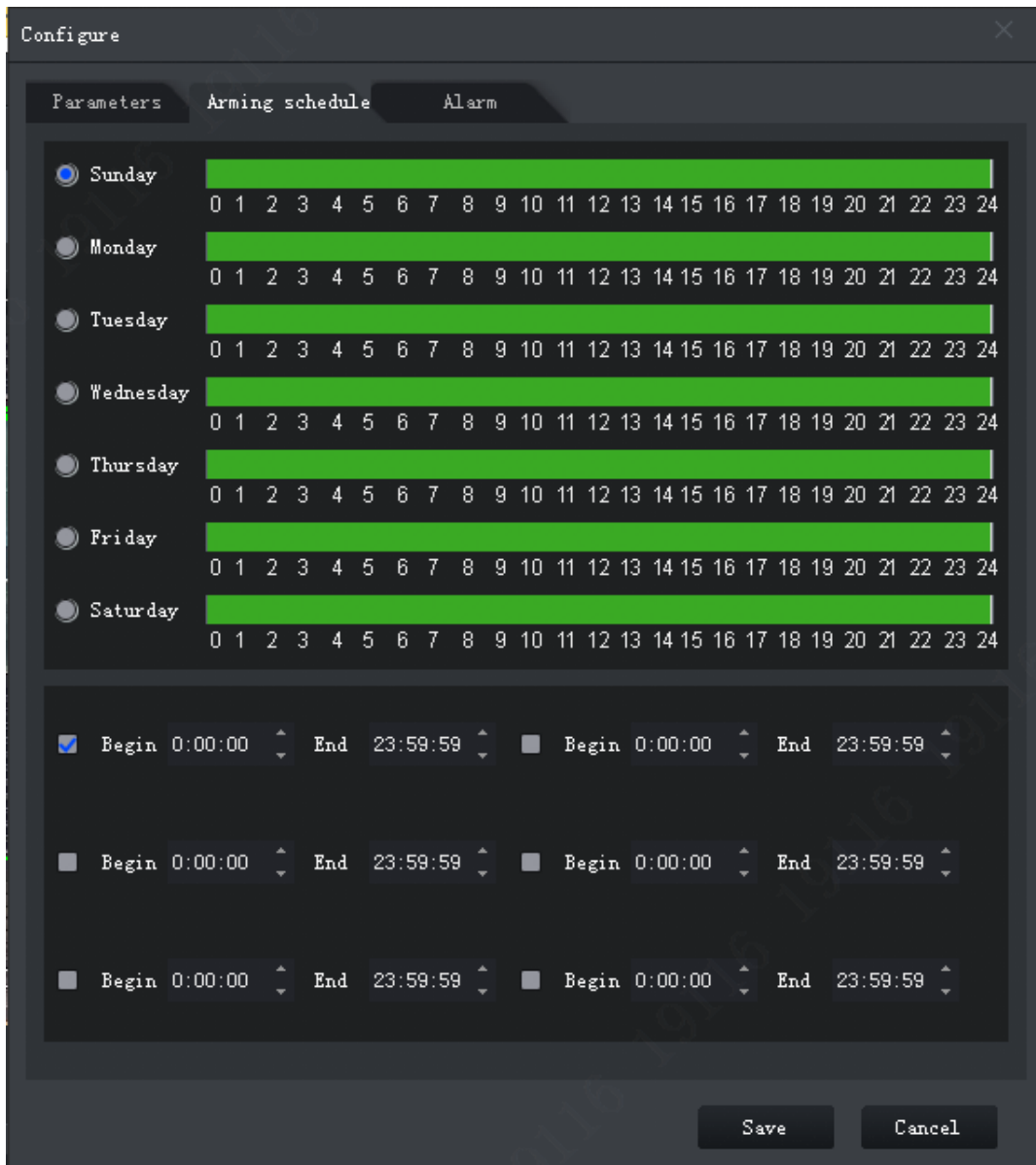

Figure 4-20

3. Click Alarm tab, set link and see Figure 4-21.

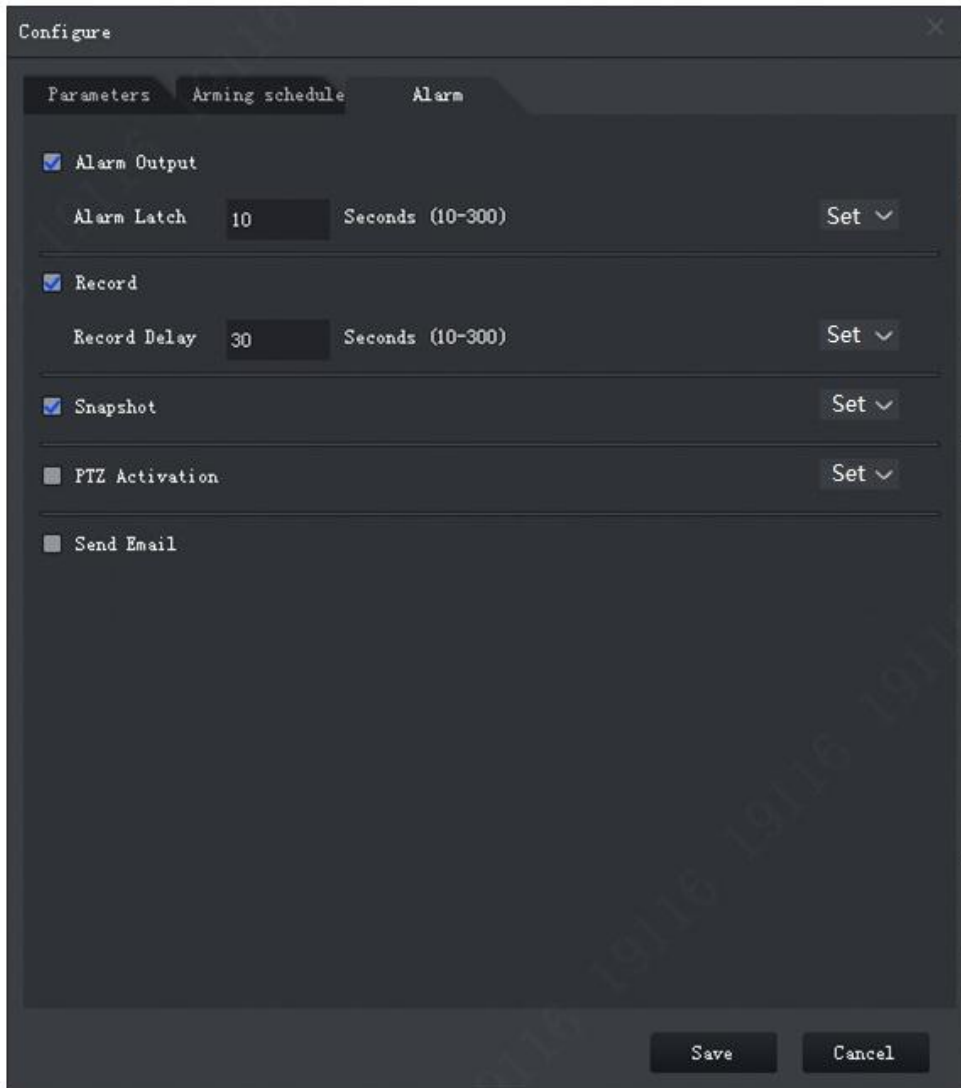



Figure 4-21

Parameter	Note
Alarm Output	At alarm output port, connect to device (such as light, siren and etc. When alarm is triggered, system will send alarm info to alarm device.
Alarm Latch	Alarm will be on for a while after alarm ends.
Record	When alarm is triggered, system auto records.  Please enable auto record function, otherwise record will fail.
Record Delay	Record will be on for a while after alarm ends.
Snapshot	When alarm is triggered, snapshot.  Refer to 8 System Config
	Click Setup next to alarm latch, and select alarm output channel.
	Click Setup next to record and select record channel.
	Click Setup next to snapshot, you can select snapshot channel.

Parameter	Note
PTZ Activation	When alarm is triggered, link to PTZ. Click Setup net to PTZ Activation, select activation method, including presser, track and pattern. Meantime input no. correspondingly.
Send Email	When face detection alarm occurs, send email to set email adress.  Complete setup of Email, refer to 8 System Config

Chart 4-4

4. Click OK to save.

Step 5

Draw target filter box, see Figure 4-22. Filter box is used to filter object that is too big or too small, so only when a target is inside the box, it will alarm.

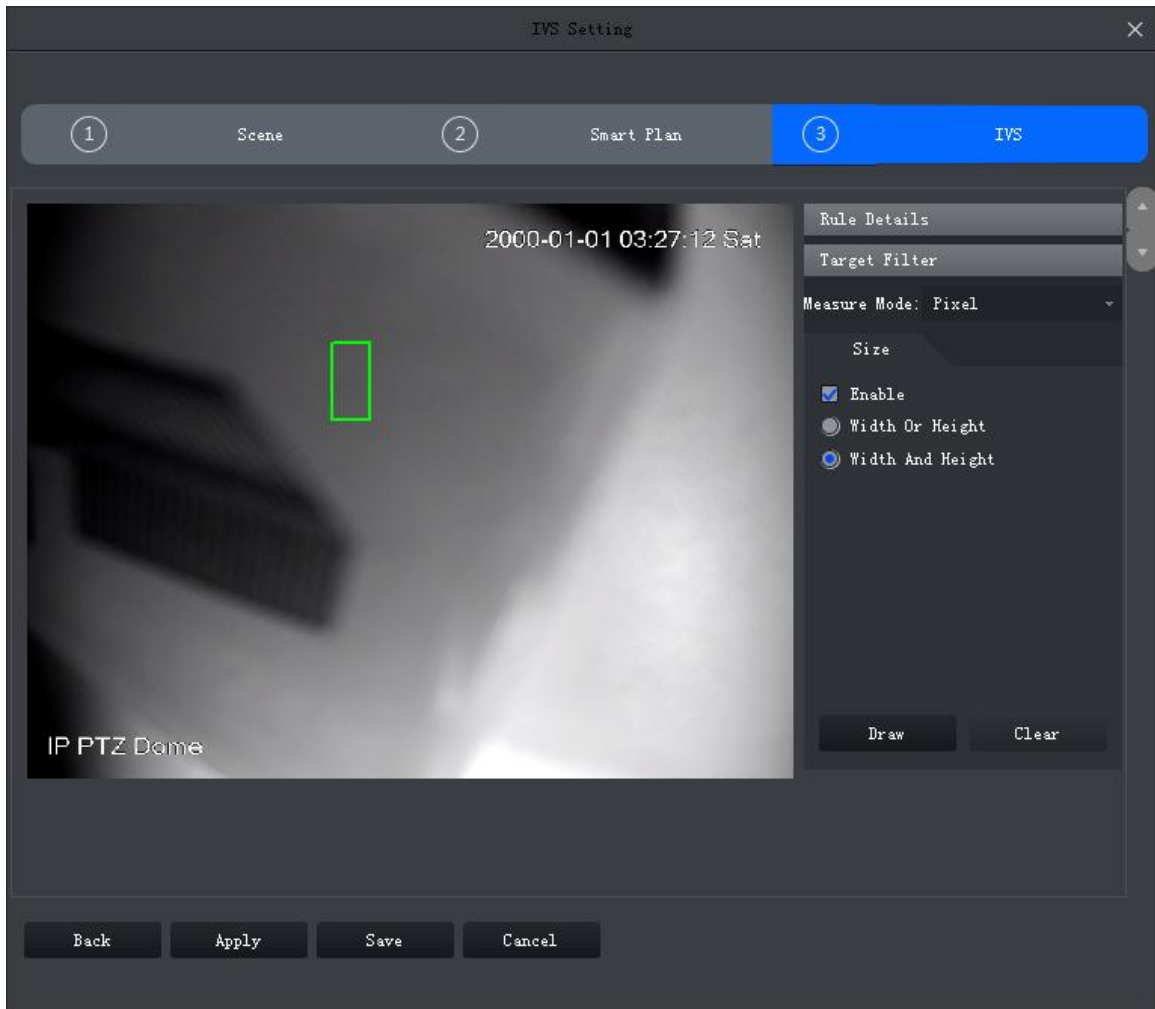

Figure 4-22

1. Select Enable.

2. Select filter method:

Width or height, as any of the two factors is matched, target will be kept.

Width and height, as both of the two factors are matched, target will be kept.

3. Click Draw, and draw filter box in video window. Select filter box, drag four angles to zoom in or out.



Select filter box, click Clear to delete box.

Step 6

Click Save.

4.4.2.4.2 Tripwire

When target enters tripwire in set direction, alarm is triggered. See Figure 4-23.

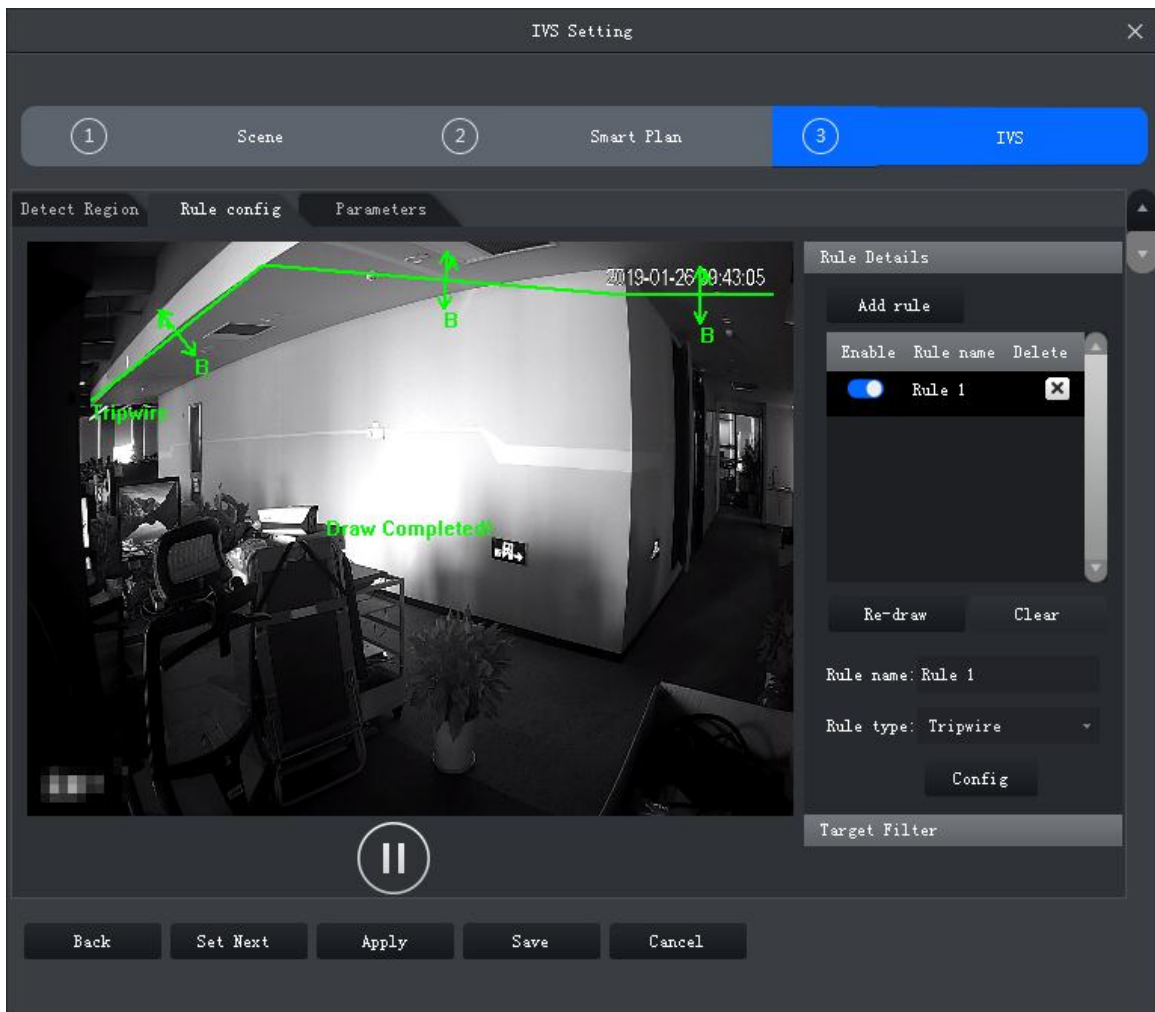



Figure 4-23

Step 1

Click Add rule.

Step 2

Enable rule and modify rule name and type.

1. Enable rule,  means to enable corresponding IVS rule.
2. Modify rule name.

3. In Rule type dropdown list, select Tripwire.

Step 3

In monitoring video, draw tripwire, and right click to stop drawing.



Select existing tripwire rule, click **Clear** or Re-draw to draw again.

Step 4

Set parameter, arm time and alarm link. Draw target filter, see **4.4.2.4.1 Crossing Virtual Fence**

Step 5

Click Apply.

4.4.2.4.3 Intrusion

When a target enters exits or appears in detection zone, alarm is triggered.

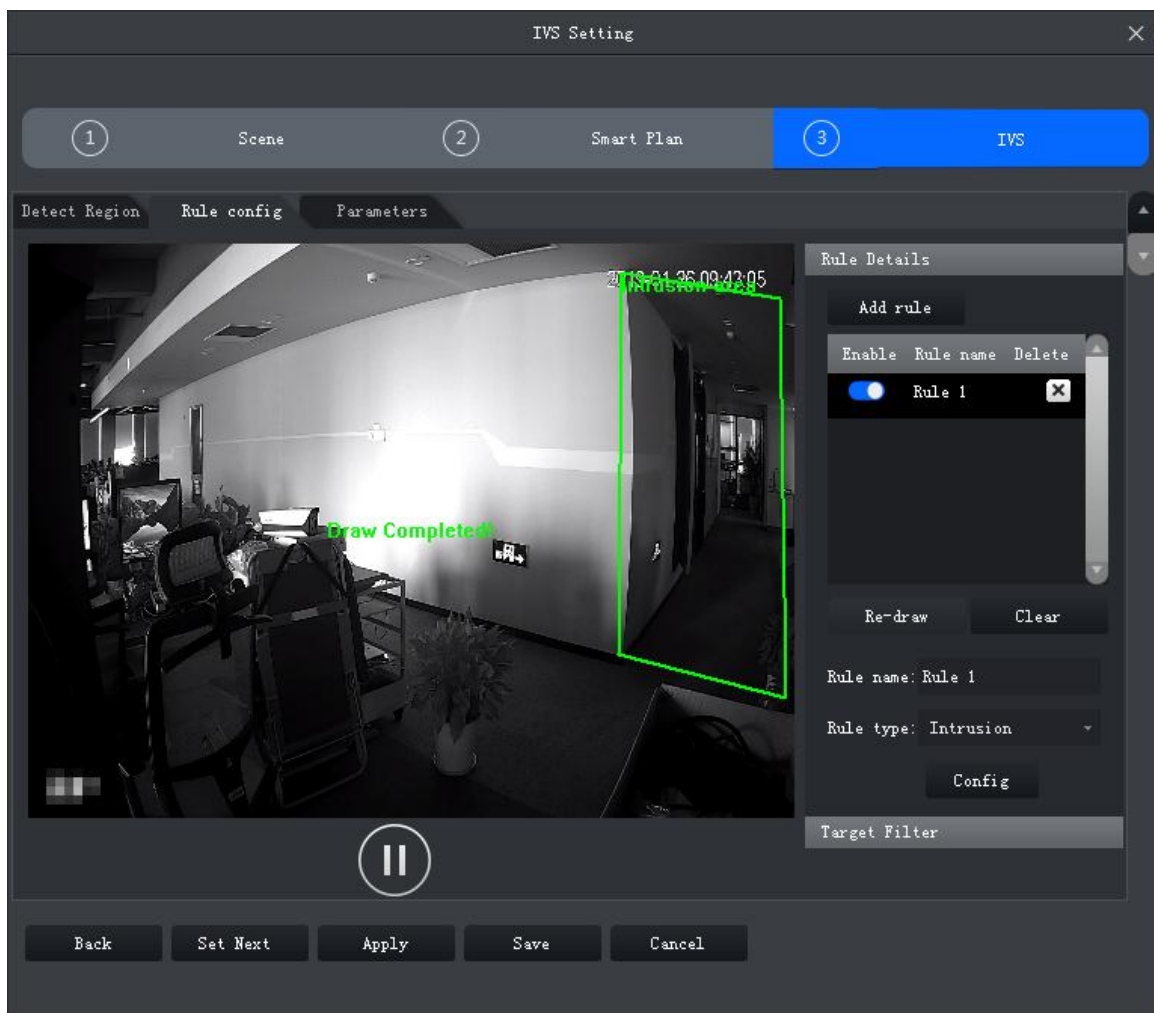



Figure 4-24

Step 1

Click Add rule.

Step 2

Enable rule and modify rule name and type.

1. Enable rule,  means to enable corresponding IVS rule.
2. Modify rule name.
3. In Rule type dropdown list, select Intrusion.

Step 3

In monitoring video, draw detection zone, and right click to stop drawing.



Select existing detection zone, click **Clear** or Re-draw to draw again.

Step 4

Set parameter, arm time and alarm link. Draw target filter, see **4.4.2.4.1 Crossing Virtual Fence**

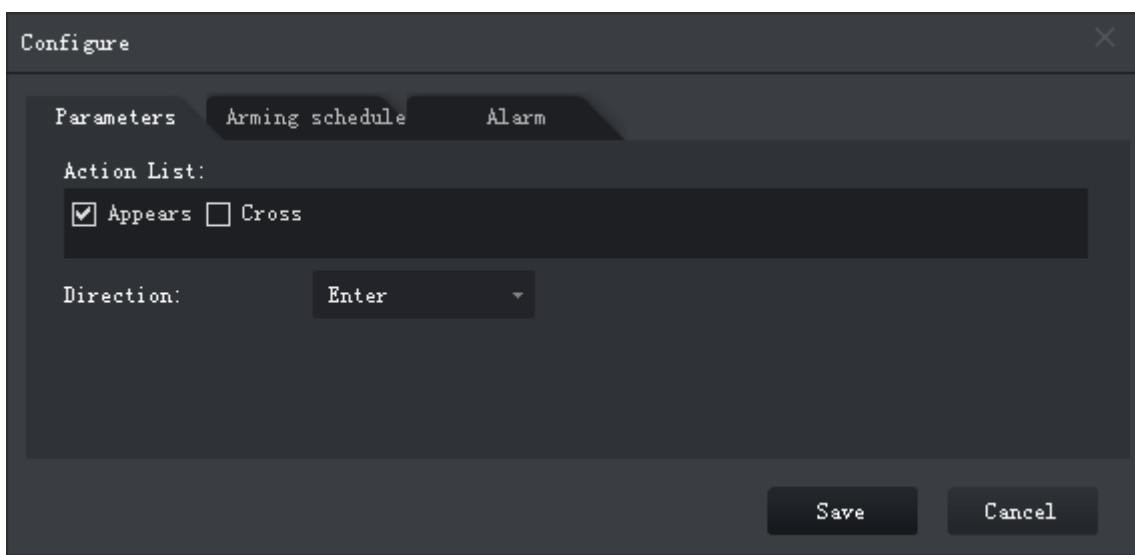

Figure 4-25

Parameter	Note
Action List	Include appears zone and cross zone.
Direction	When detection action is set to cross, this direction is valid. Direction includes enter, leave and bidirectional.

Chart 4-5

Step 5

Click Apply.

4.4.2.4.4 Abandoned Object

When a target stays in detection zone over a certain period of time, alarm is triggered.

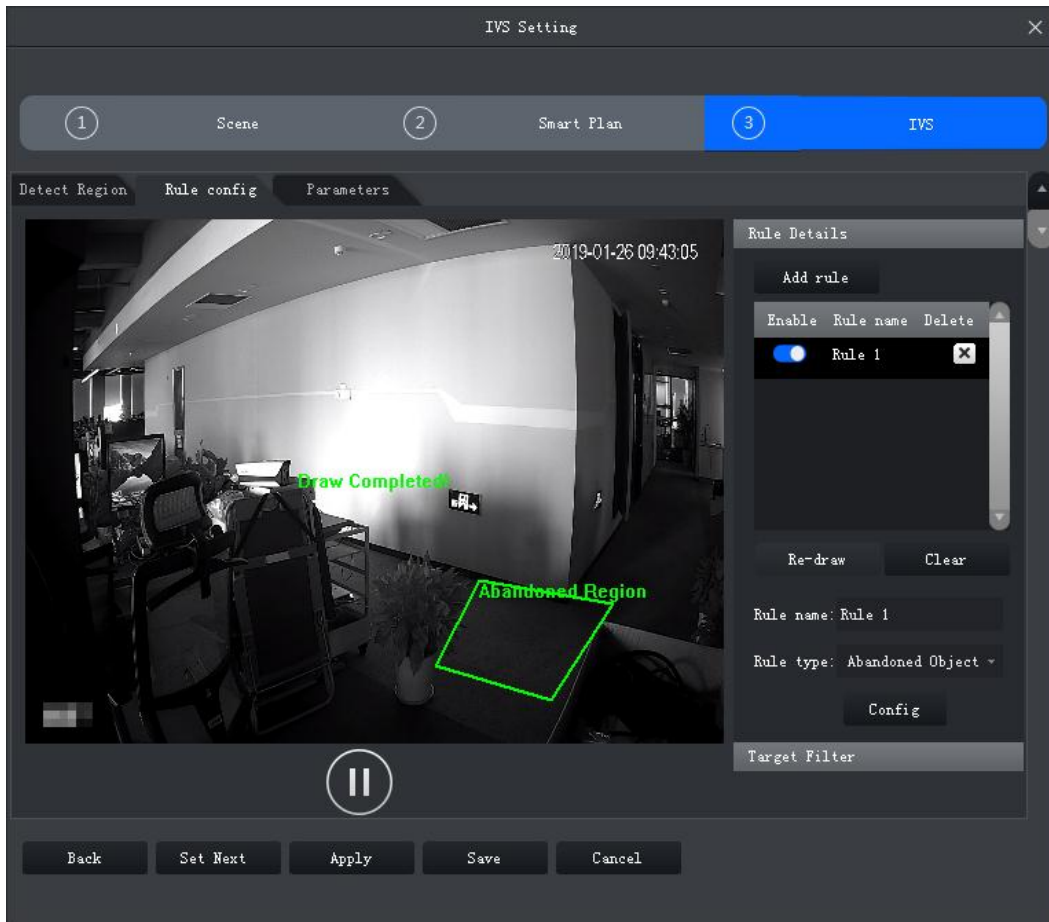



Figure 4-26

Step 1

Click Add rule.

Step 2

Enable rule and modify rule name and type.

1. Enable rule,  means to enable corresponding IVS rule.
2. Modify rule name.
3. In Rule type dropdown list, select **Abandoned Object**.

Step 3

In monitoring video, draw detection zone, and right click to stop drawing.



Select existing detection zone, click **Clear** or Re-draw to draw again.

Step 4

Set parameter, arm time and alarm link. Draw target filter, see **4.4.2.4.1 Crossing Virtual Fence**

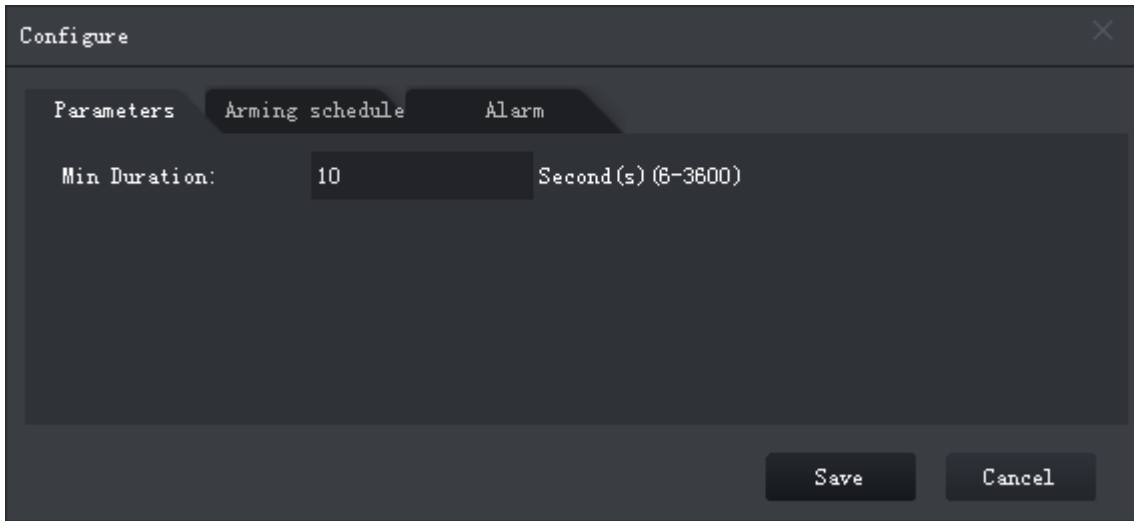

Figure 4-27

Parameter	Note
Min Duration	Min duration from a target appears in detection zone to trigger of alarm.

Chart 4-6

Step 5

Click Apply.

4.4.2.4.5 Fast Moving

When a target moves at speed reaching preset value and duration of movement reaches preset time length, alarm is triggered.



Only when calibration of global variable is complete, fast moving judgment is accurate, see 4.4.2.2 Calibration

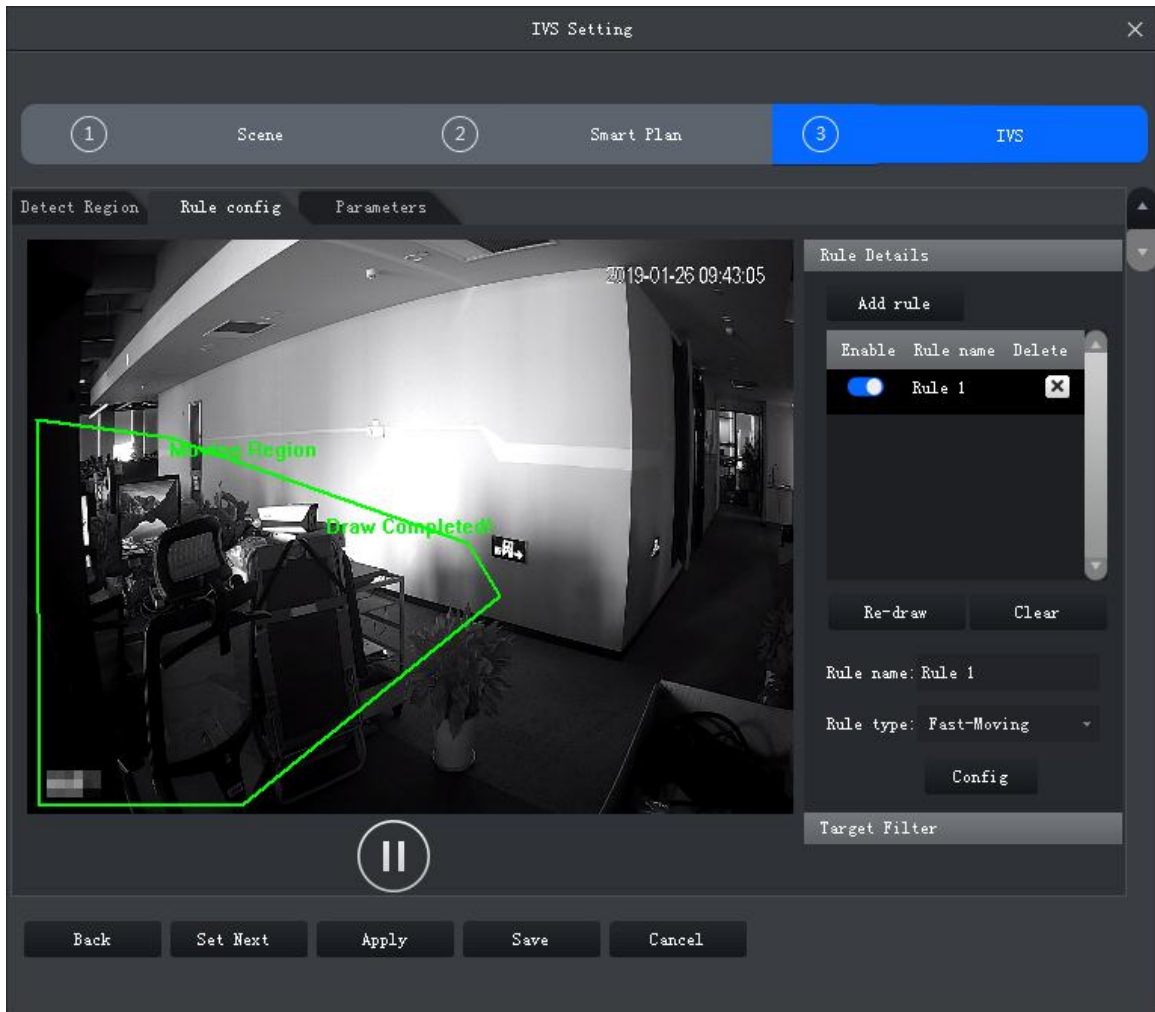



Figure 4-28

Step 1

Click Add rule.

Step 2

Enable rule and modify rule name and type.

1. Enable rule,  means to enable corresponding IVS rule.
2. Modify rule name.
3. In Rule type dropdown list, select Fast-moving.

Step 3

In monitoring video, draw detection zone, and right click to stop drawing.



Select existing detection zone, click **Clear** or **Re-draw** to draw again.

Step 4

Set parameter, arm time and alarm link. Draw target filter, see **4.4.2.4.1 Crossing Virtual Fence**

See Figure 4-29.

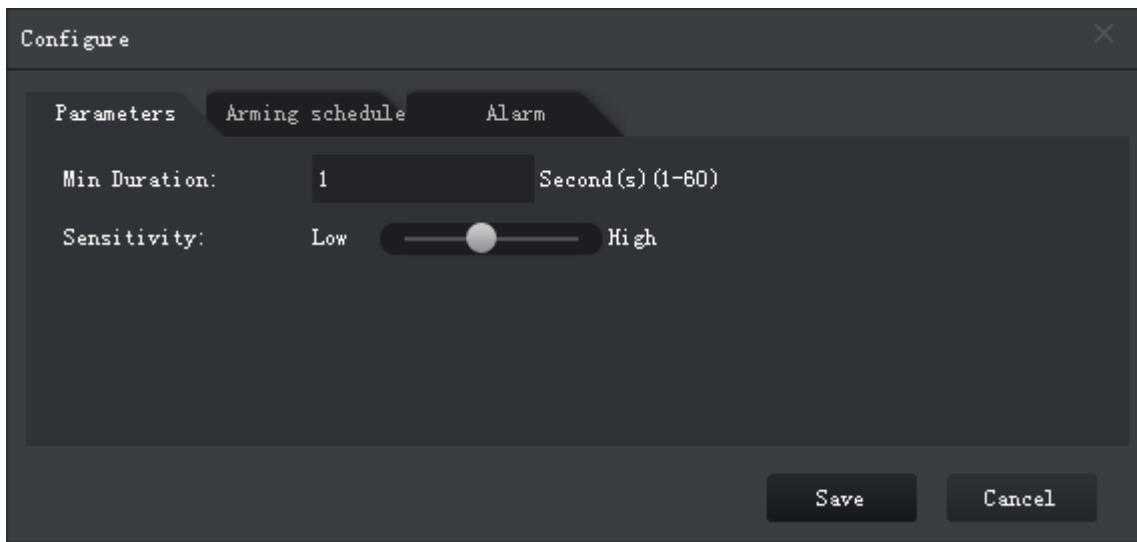

Figure 4-29

Parameter	Note
Min Duration	Min duration of target fast moving in detection zone.
Sensitivity	The higher the sensitivity is, the easier to trigger alarm while more interference will be caused. Default setup is recommended.
Sensitivity	The higher the value is, the easier it is to trigger alarm, but meanwhile it causes more disturbances upon alarm. It is recommended to adopt default setting.

Chart 4-7

Step 5

Click Apply.

4.4.2.4.6 Parking Detection

When a target parks in detection area over a certain time, alarm is triggered.

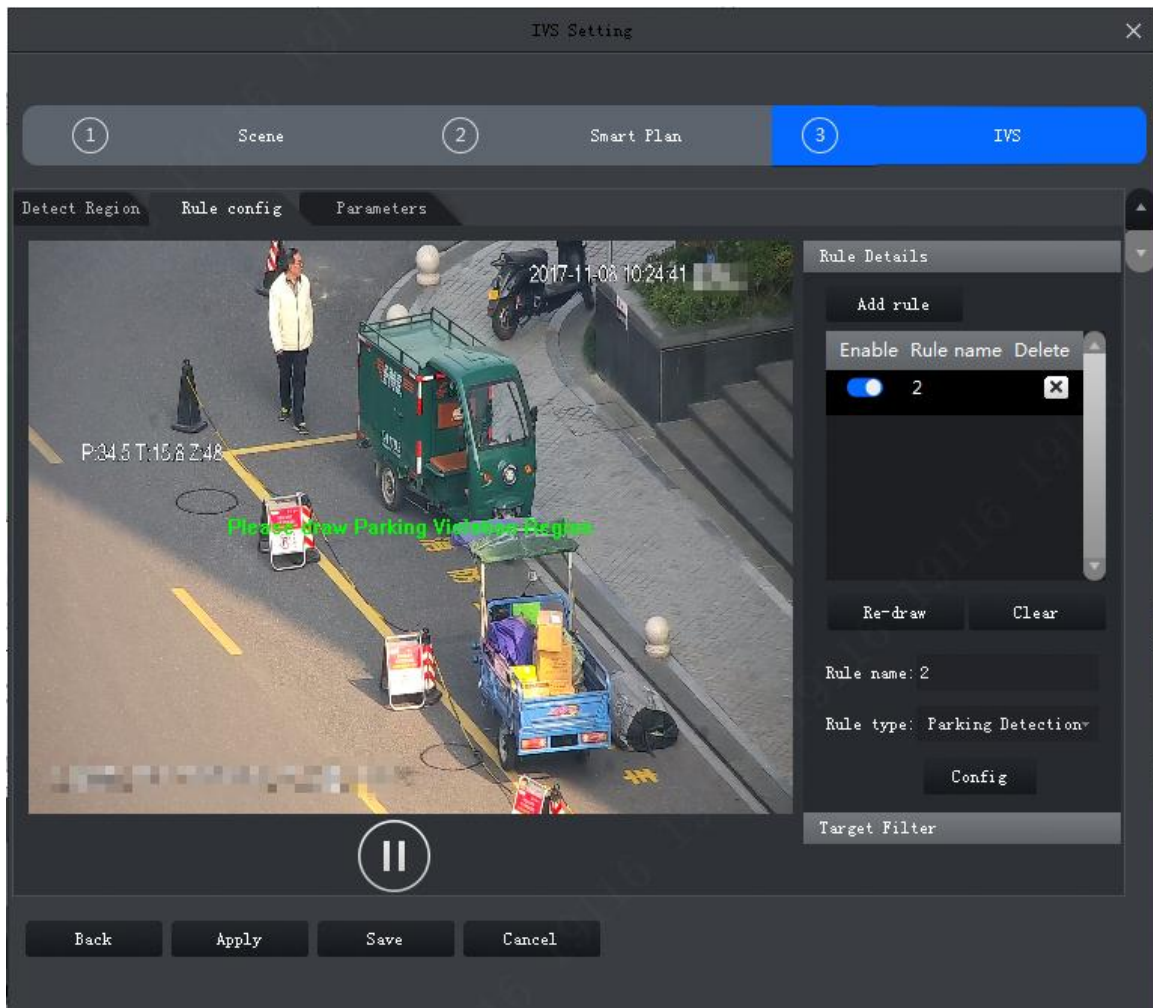



Figure 4-30

Step 1

Click Add rule.

Step 2

Enable rule and modify rule name and type.

1. Enable rule,  means to enable corresponding IVS rule.
2. Modify rule name.
3. In Rule type dropdown list, select Parking detection.

Step 3

In monitoring video, draw detection zone, and right click to stop drawing.



Select existing detection zone, click **Clear** or **Re-draw** to draw again.

Step 4

Set parameter, arm time and alarm link. Draw target filter, see 4.4.2.4.1 Crossing Virtual Fence

See Figure 4-31.

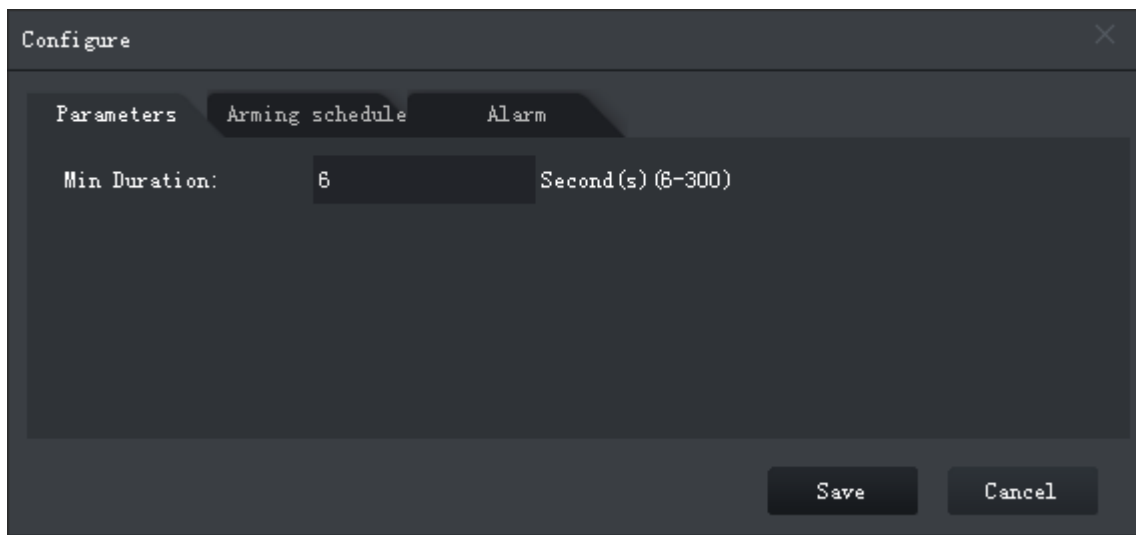

Figure 4-31

Parameter	Note
Min Duration	Min time period between target vehicle appearance in detection and alarm trigger.

Chart 4-8

Step 5

Click Apply.

4.4.2.4.7 Crowd Gathering

When crowd gathers in detection zone and exceeding set quantity of people, alarm is triggered.

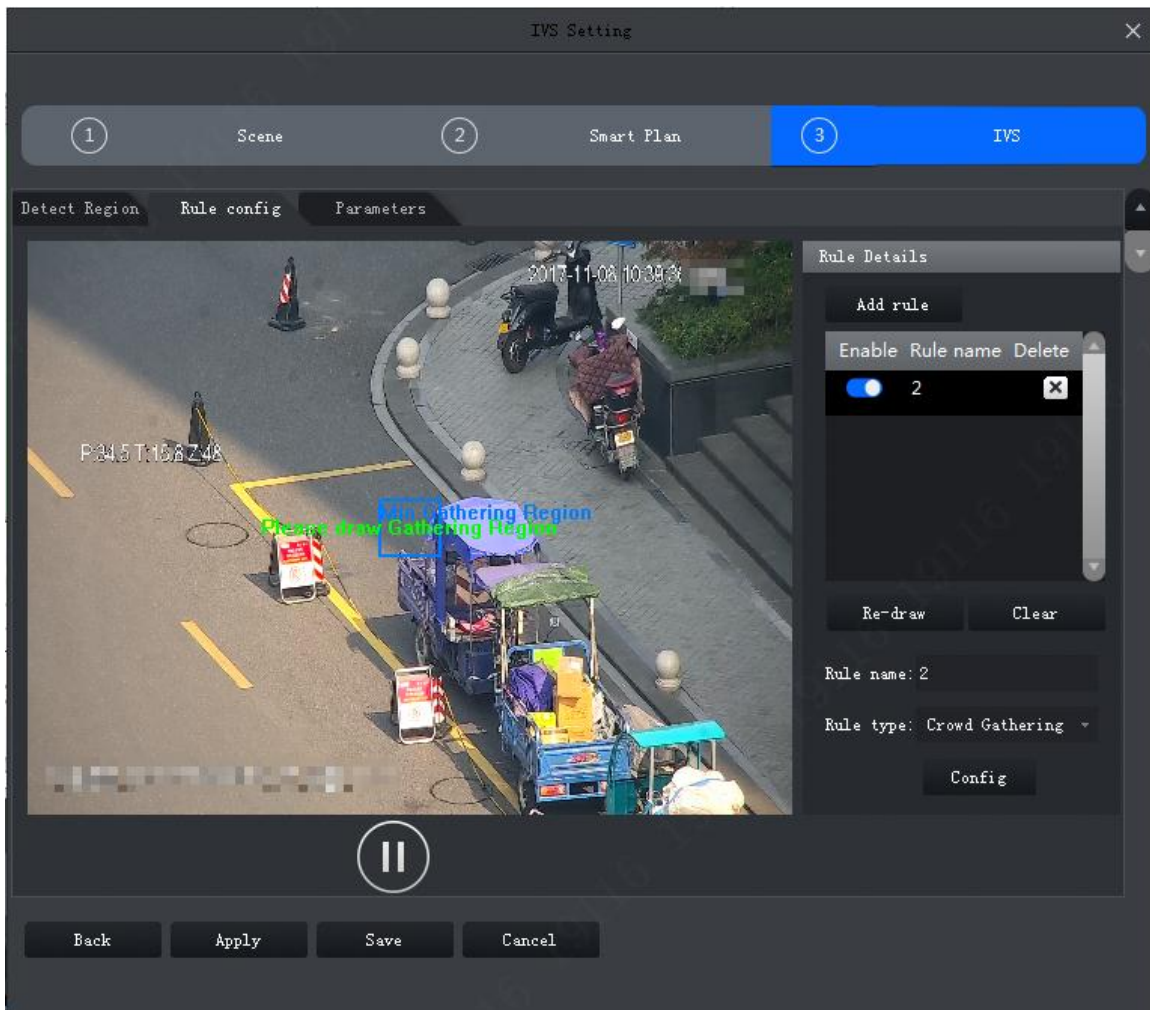



Figure 4-32

Step 1

Click Add rule.

Step 2

Enable rule and modify rule name and type.

1. Enable rule,  means to enable corresponding IVS rule.
2. Modify rule name.
3. In Rule type dropdown list, select Crowding gathering.

Step 3

In monitoring video, draw detection zone, and right click to stop drawing. Click min crowd gathering zone, adjust size by dragging the four angles.



- Select gathering zone or min gathering zone; click Clear to delete gathering zone and min gathering zone.
- Select gathering zone or min gathering zone, click Re-draw to draw again.

Step 4

Set parameter, arm time and alarm link. Draw target filter, see **4.4.2.4.1 Crossing**

Virtual Fence

See Figure 4-33.

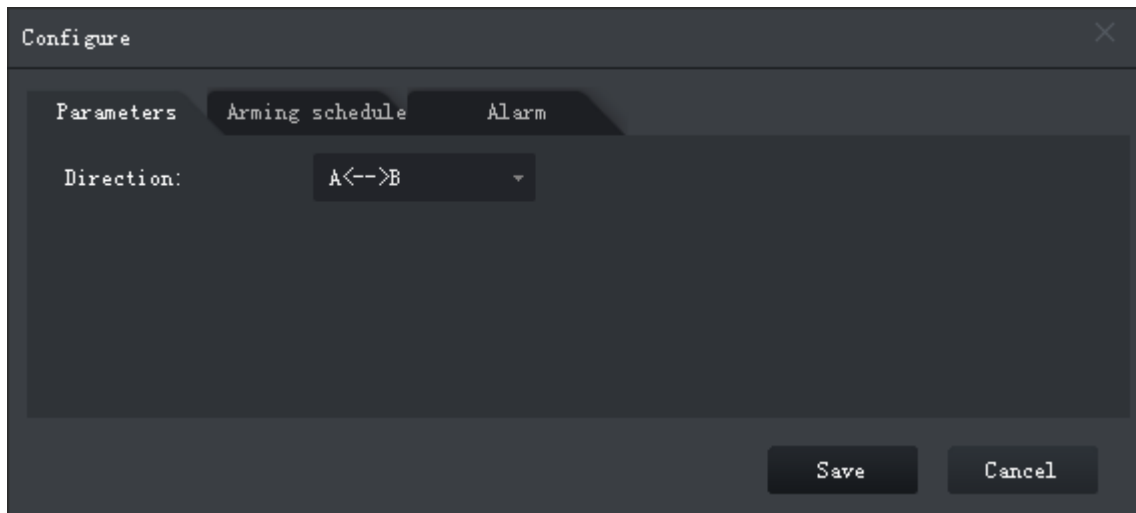

Figure 4-33

Parameter	Note
Min Duration	Min time period between people gathering in detection and alarm trigger.
Report Interval	When alarm is triggered, if alarm event still exists, then you can set interval to alarm again and again.
Sensitivity	The higher the sensitivity is, the easier to trigger alarm while more interference will be caused. Default setup is recommended.

Chart 4-9

Step 5

Click Apply.

4.4.2.4.8 Missing Object

When an object is moves out from detection zone, alarm is triggered.

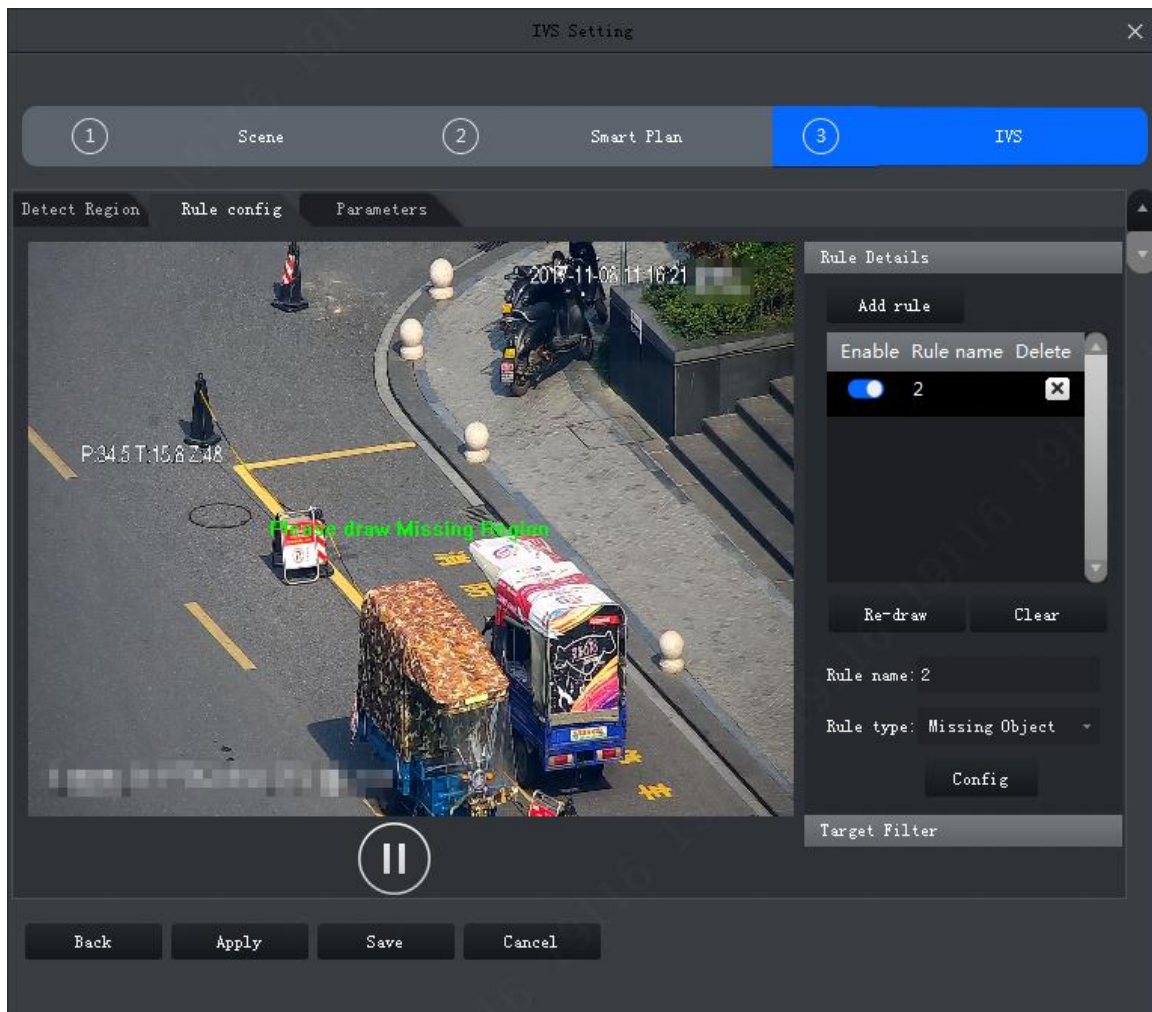



Figure 4-34

Step 1

Click Add rule.

Step 2

Enable rule and modify rule name and type.

1. Enable rule,  means to enable corresponding IVS rule.
2. Modify rule name.
3. In Rule type dropdown list, select Missing object.

Step 3

In monitoring video, draw detection zone, and right click to stop drawing.



Select existing detection zone, click Clear or Re-draw to draw again.

Step 4

Set parameter, arm time and alarm link. Draw target filter, see 4.4.2.4.1 Crossing Virtual Fence.

See Figure 4-35.

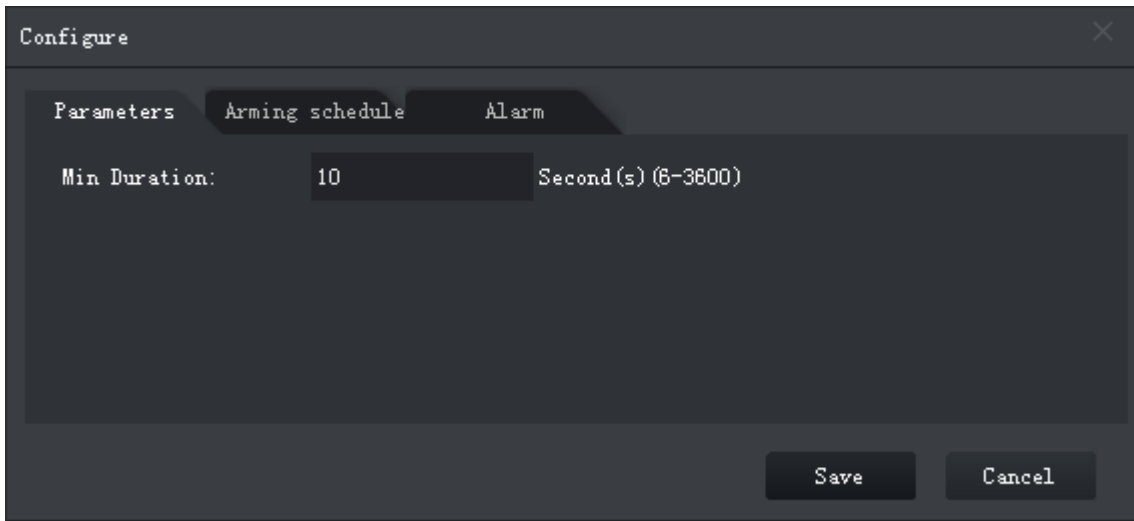

Figure 4-35

Parameter	Note
Min Duration	Min time period between the object leaves detection zone and alarm trigger.

Chart 4-10

Step 5

Click Apply.

4.4.2.4.9 Loitering Detection

When a target stays too long over set time length in detection zone, alarm is triggered.

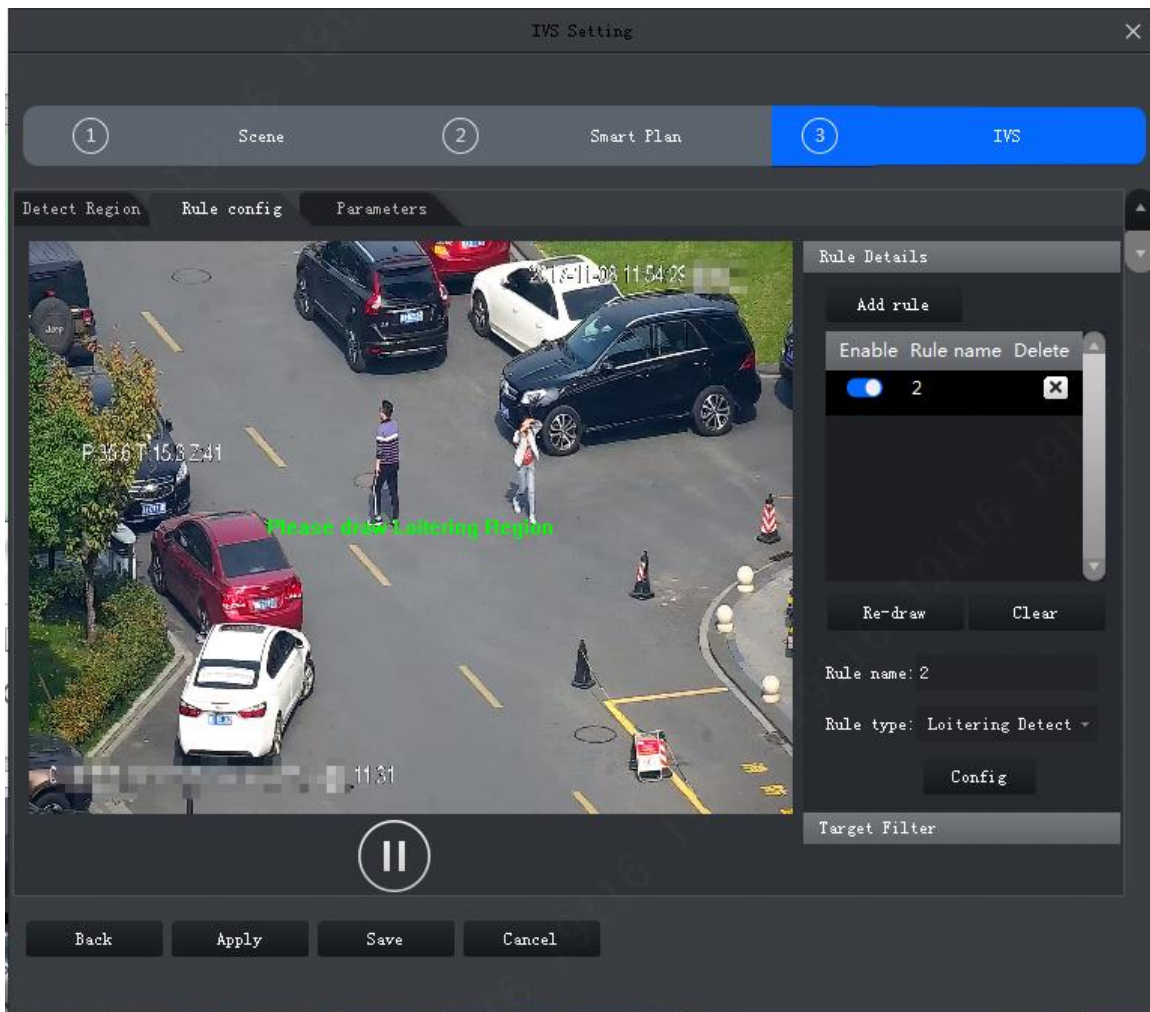



Figure 4-36

Step 1

Click Add rule.

Step 2

Enable rule and modify rule name and type.

1. Enable rule,  means to enable corresponding IVS rule.
2. Modify rule name.
3. In Rule type dropdown list, select Loitering detection.

Step 3

In monitoring video, draw detection zone, and right click to stop drawing.



Select existing detection zone, click **Clear** or **Re-draw** to draw again.

Step 4

Set parameter, arm time and alarm link. Draw target filter, see 4.4.2.4.1 Crossing Virtual Fence

See Figure 4-37.

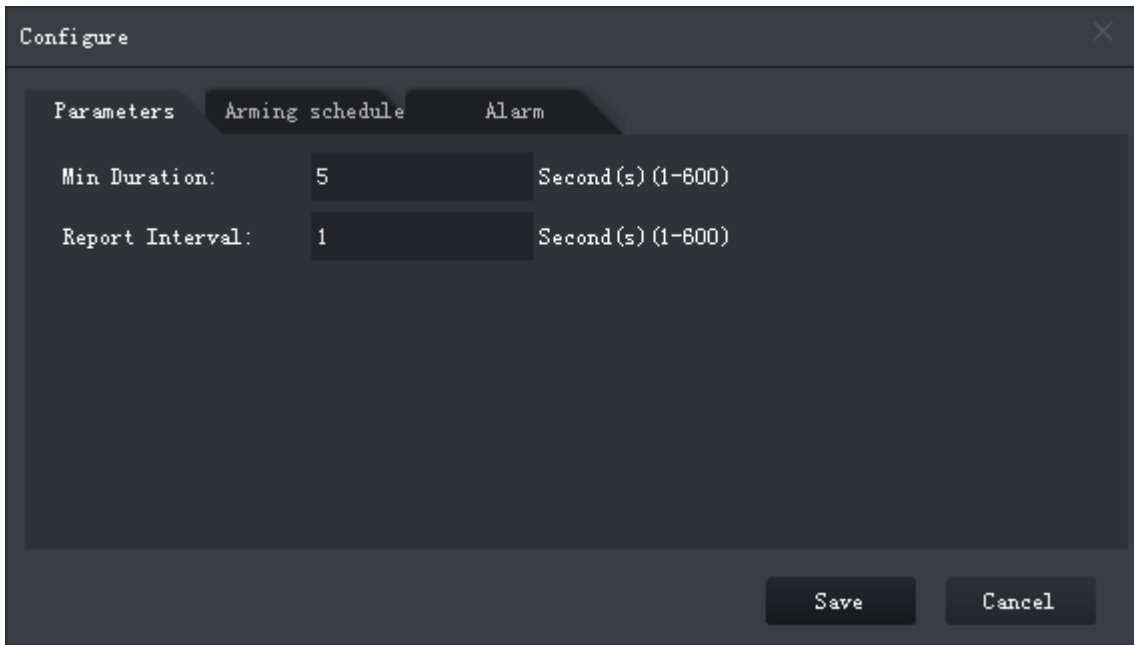

Figure 4-37

Parameter	Note
Min Duration	Min time period between the object loiters in detection zone and alarm trigger.
Report Interval	When alarm is triggered, if alarm event still exists, then you can set interval to alarm again and again.

Chart 4-11

Step 5

Click Apply.

4.4.2.5 Parameters

Set global parameters for general behavior analysis, including whether to anti-jitter and add shadow in video and set sensitivity.

Step 1

In Rule config tab, complete IVS rule setting and click Parameters tab. See Figure 4-38.

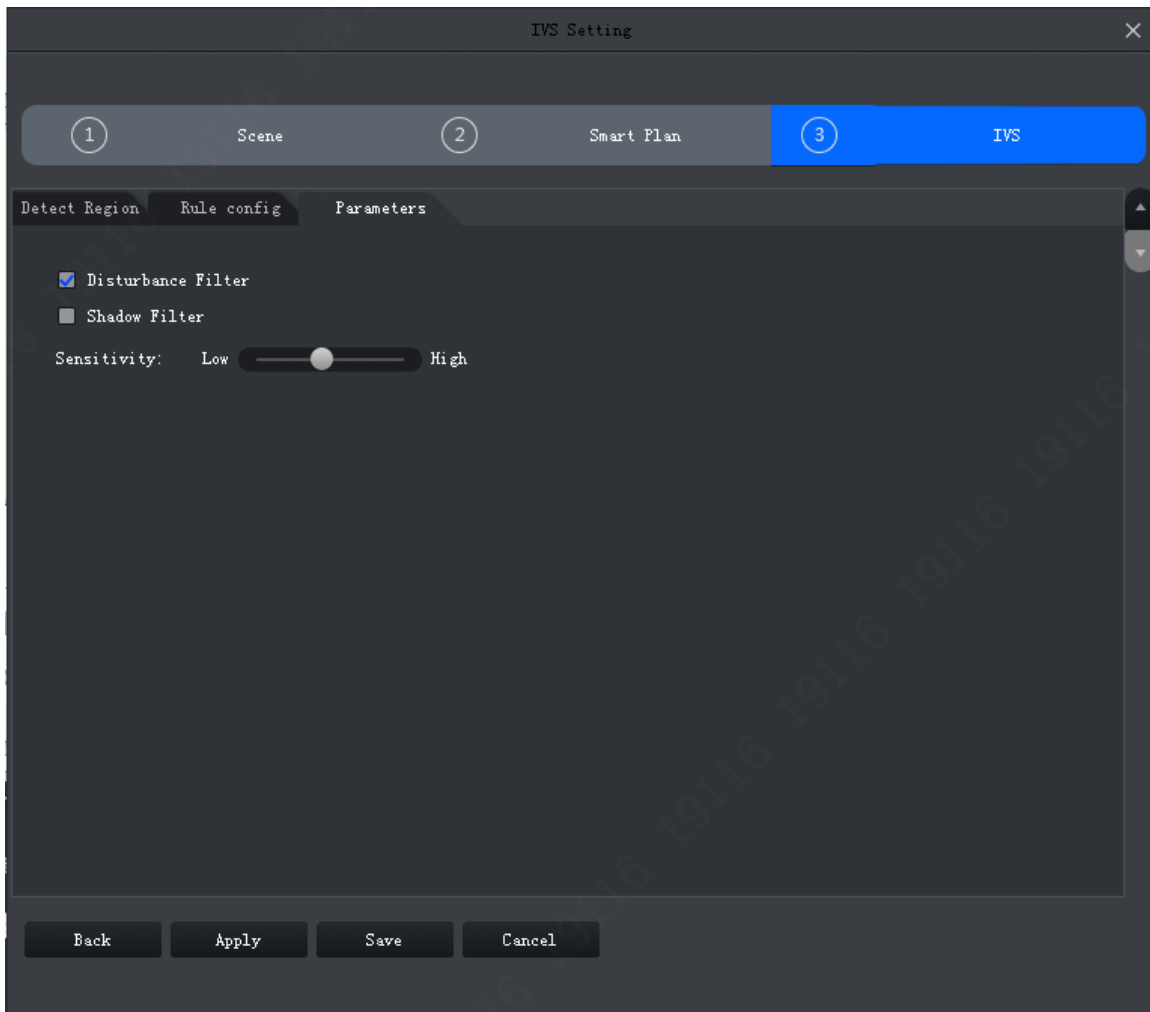

Figure 4-38

Step 2

Set parameter, see Chart 4-12.

Parameter	Note
Disturbance Filter	Filter disturbance of random swing (i.e. water wave and etc.), generally used in outdoor environment. This function may cause miss-detection.
Shadow Filter	Filter shadow, if not enabled, then system will auto detect target shadow.
Sensitivity	Sensitivity of control target. The lower the value, the less wrong detection will be, but missed detection will be more. Sensitivity is from low to high with scene from fewer to more.

Chart 4-12

Step 3

Click Save.

4.4.3 Face Detection

Face detection supports detecting pedestrians in the specific area and capture clear face picture; besides, facial features can be clearly captured and recognized, including gender, age, expression and wearing glasses or not.

4.4.3.1 Enabling Face Detection

Step 1

Click **Next** after setting preset on the Scene interface.

The interface of Smart Plan is displayed. See Figure 4-39.

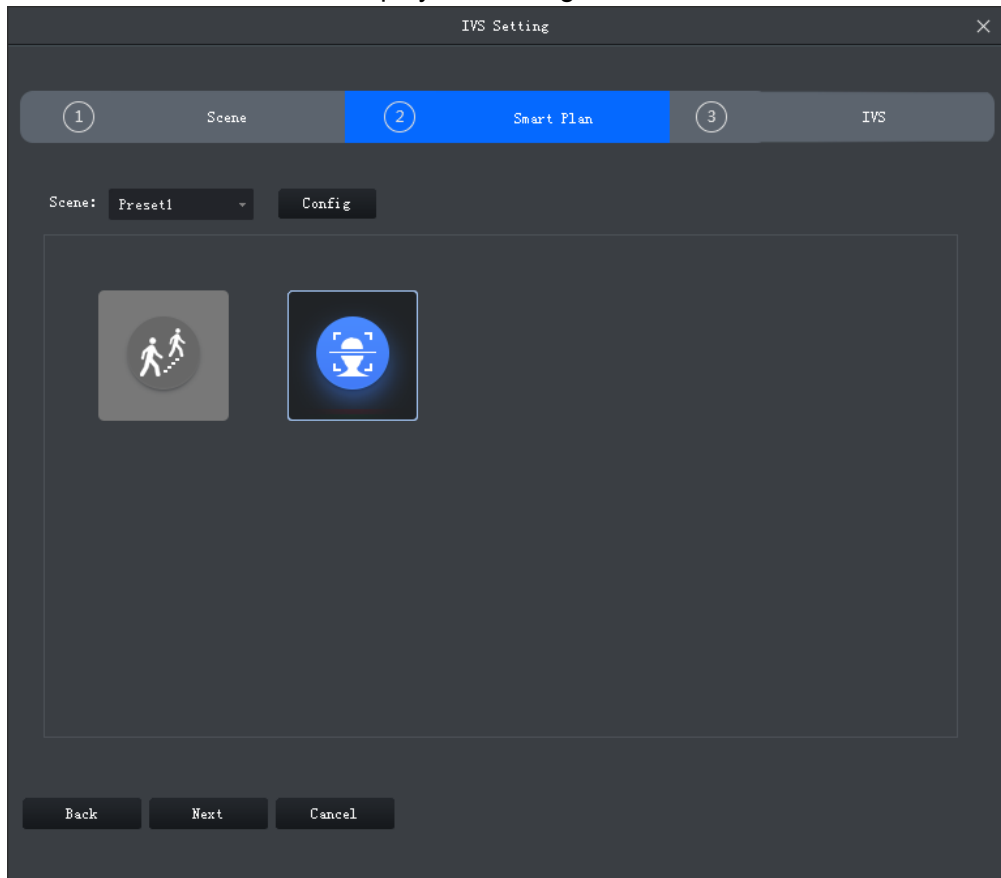



Figure 4-39

Step 2

Select scene according to your needs.

Step 3

Click  and select smart plan of face detection.

The smart plan is selected when the white frame appears next to the icon. If you select other smart plans (mutually exclusive with face detection), first it needs to click corresponding icon to cancel selection, then click  to select smart plan of face detection.

4.4.3.2 Configuring Face Detection Rules

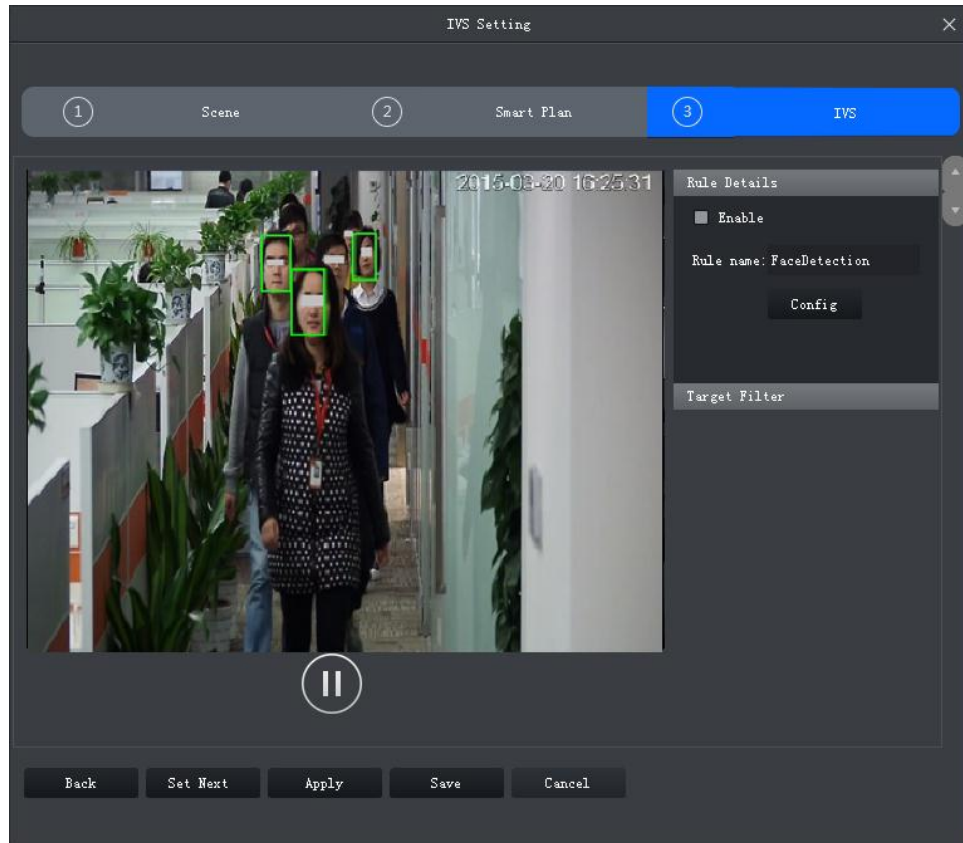

Figure 4-40

Step 1

Click Enable to enable face detection.

Step 2

Modify Rule Name.

Step 3

Configure arm time and alarm linkage.

1. Click Config and the interface of Config is displayed. See Figure 4-41.



Figure 4-41

2. Click Arming Schedule, select week and period according to actual requirement, input start time and end time.



The factory default arm time is 24 hours every day.

3. Click Alarm, set alarm linkage mode. See Figure 4-42. For more parameter details. See Chart 4-13

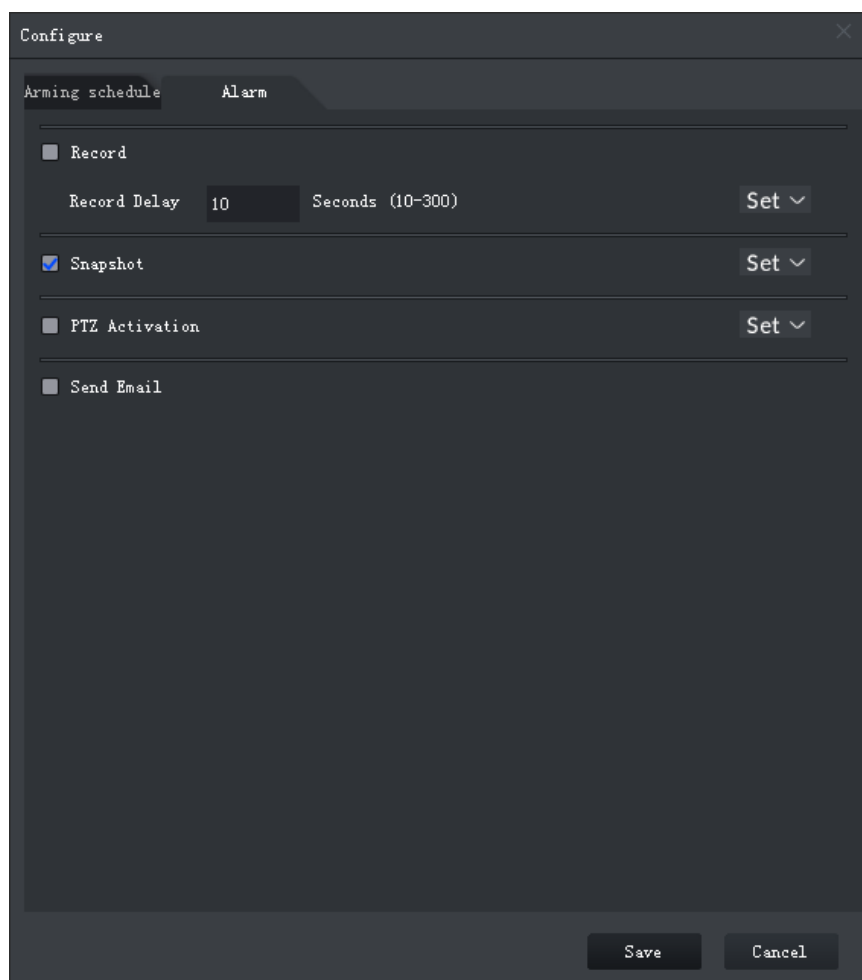



Figure 4-42

Parameter	Description	
Record	The system logs in automatically when alarm is triggered.  Please enable auto record; otherwise it will fail to record.	Click Set and you can select recording channel.
Record Delay	After alarm is over, it will continue to record for a period of time before stop.	
Snapshot	Capture picture when triggering alarm.  Please refer to 8 System Config for snapshot storage path query and setting.	Click Set and you can select snapshot channel.
PTZ Activation	Activate PTZ operation when triggering alarm.	Click Set and select linkage mode, including preset, tour and pattern, meanwhile inputting corresponding number.

Parameter	Description	
Send Email	Send email to designated mailbox and inform users when face detection alarm occurs.  Email can be successfully sent after Email setting is completed. For more config details, refer to 8 System Config	None

Chart 4-13

4. Click Save.

Step 4

Draw target filter box, see Figure 4-43.

Filter box is used to filter bigger or smaller targets, it will trigger alarm when the target size is within the range.

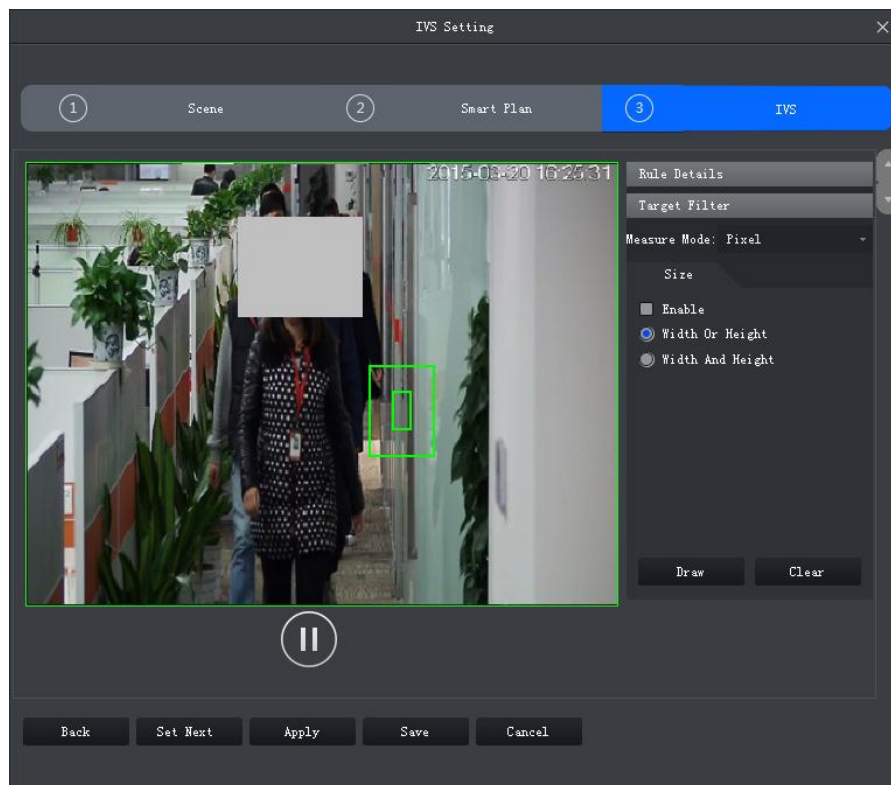

Figure 4-43

1. Click Enable.

2. Select filter mode.

Filter mode includes following two types:

- ✧ Width or height, the target is kept if either height or width meets condition.
- ✧ Width and height, the target is kept if both width and height meet condition.

3. Click Draw and you can draw filter box in the video window.

Select filter box, drag four corners to enlarge or shrink filter box to suitable size.



Select filter box, click Clear and draw again.

Step 5

Click Save.

4.4.4 People Counting

It is to count the people who enter and exit the detection area.

4.4.4.1 Enabling People Counting

Step 1

Click **Next** after setting preset on the interface of Scene Config.

The interface of **Smart Plan** is displayed. See Figure 4-57.

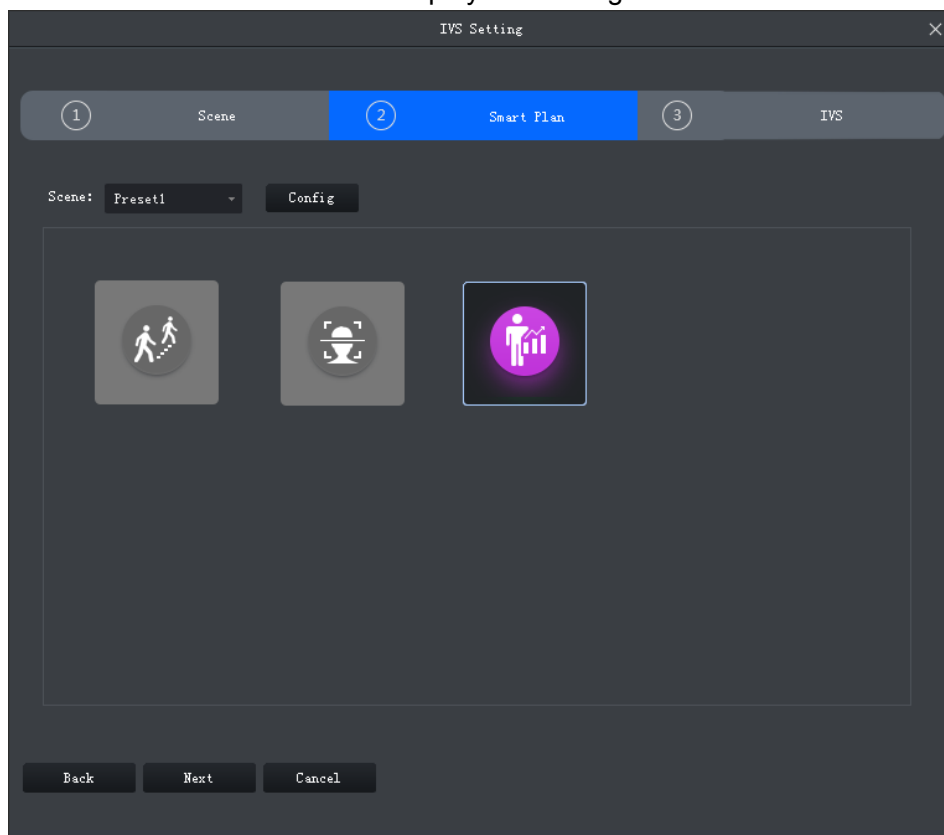



Figure 4-44

Step 2

Click  and select the smart plan of people counting.

The smart plan is selected when the white frame appears next to the icon. If you select other smart plans (mutually exclusive with people counting), first it needs to click corresponding icon to cancel selection, then click  to select smart plan of people counting.

4.4.4.2 Calibration

Please refer to **4.4.2.2 Calibration** for more details.

4.4.4.3 Configuring People Counting

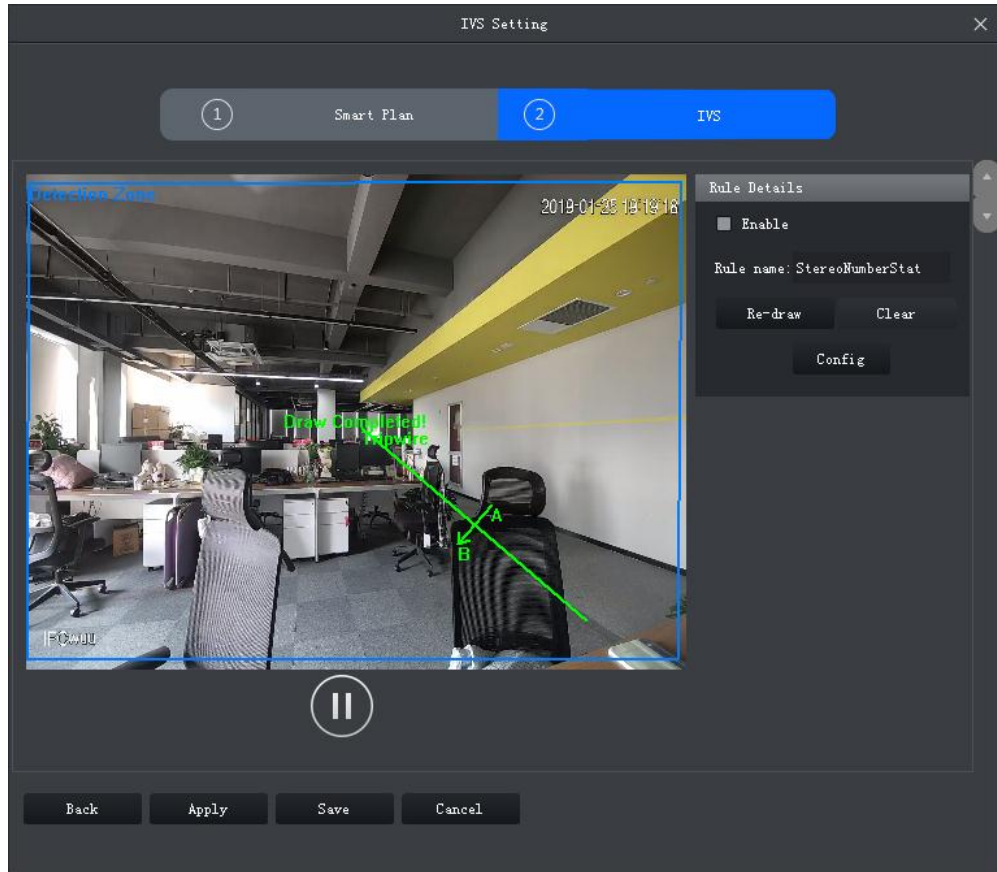

Figure 4-45

Step 1

Click Enable and people counting is enabled.

Step 2

Modify Rule Name.

Step 3

Draw statistics area o in the monitoring image.

Step 4

Configure parameters, arm period and alarm linkage.

1. Click Config to configure parameters. See Figure 4-59 . For parameter details, see Chart 4-18.

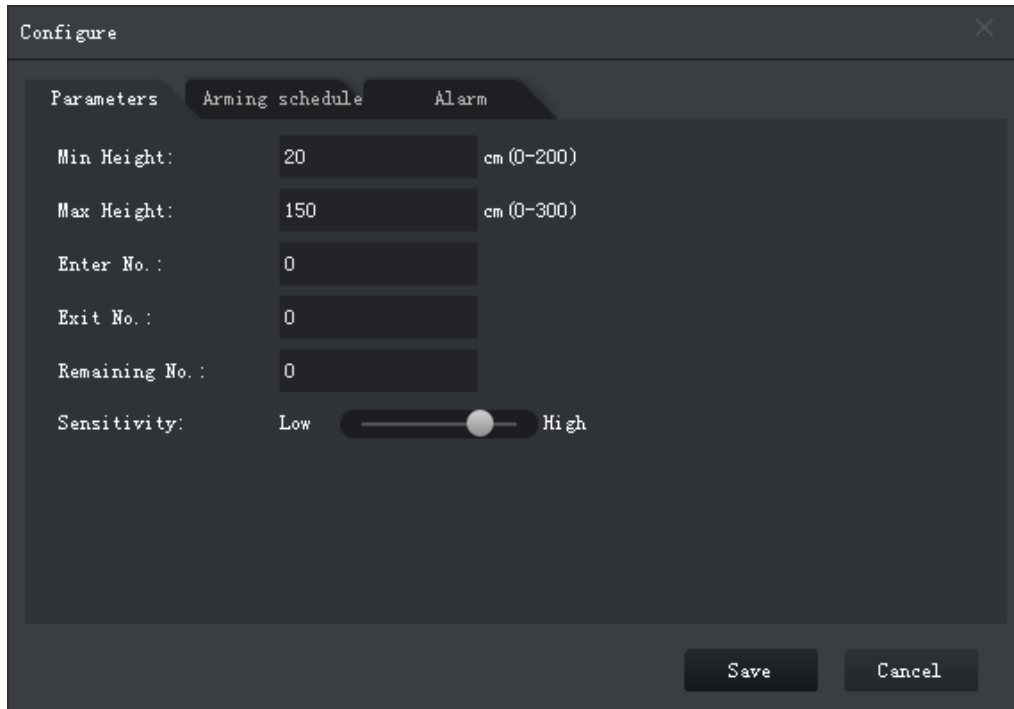

Figure 4-46

Parameter	Description
Enter No.	Alarm is triggered when enter No. exceeds threshold.
Exit No.	Alarm is triggered when exit No. exceeds threshold.
Remaining No.	Alarm is triggered when remaining No. exceeds threshold.
Sensitivity	Sensitivity of control target. The lower the value, the less wrong detection will be, but missed detection will be more. Sensitivity is from low to high with scene from fewer to more.

Chart 4-14

2. Click Arming Schedule, select week and period according to actual requirement, input start time and end time. See Figure 4-47.



The factory default arm time is 24 hours every time.

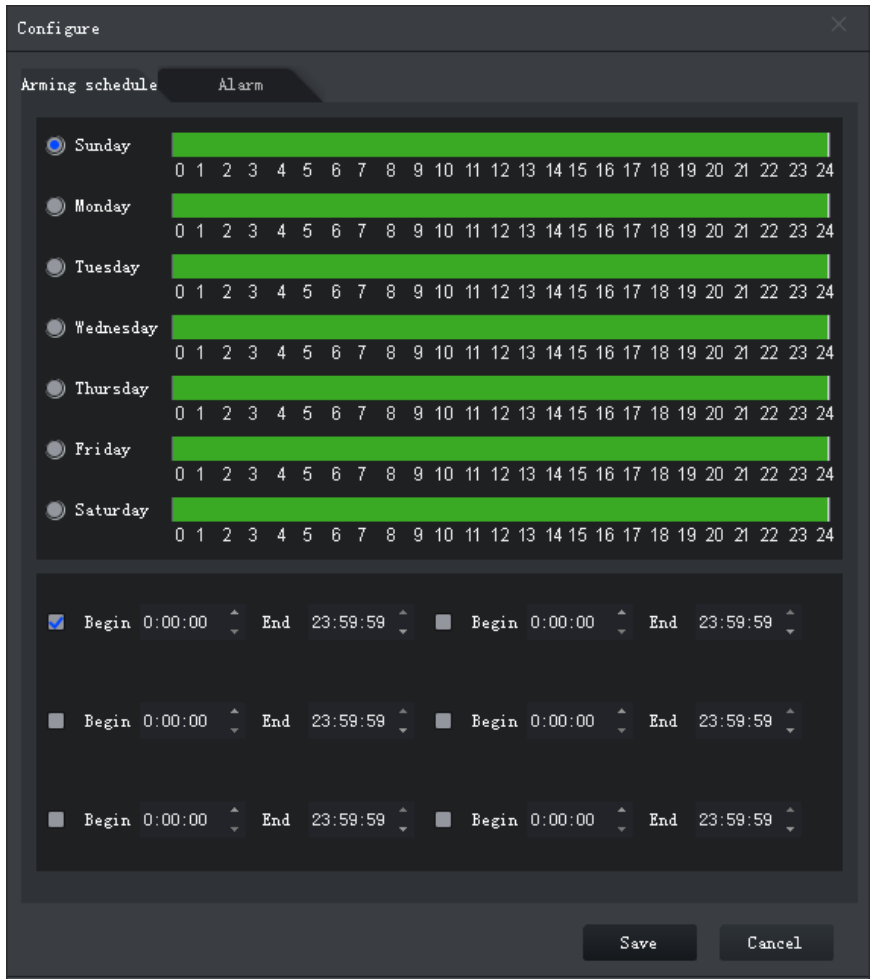

Figure 4-47

- 3. Click Alarm and set alarm linkage mode. See Figure 4-48. For parameter details, see Chart 4-15.

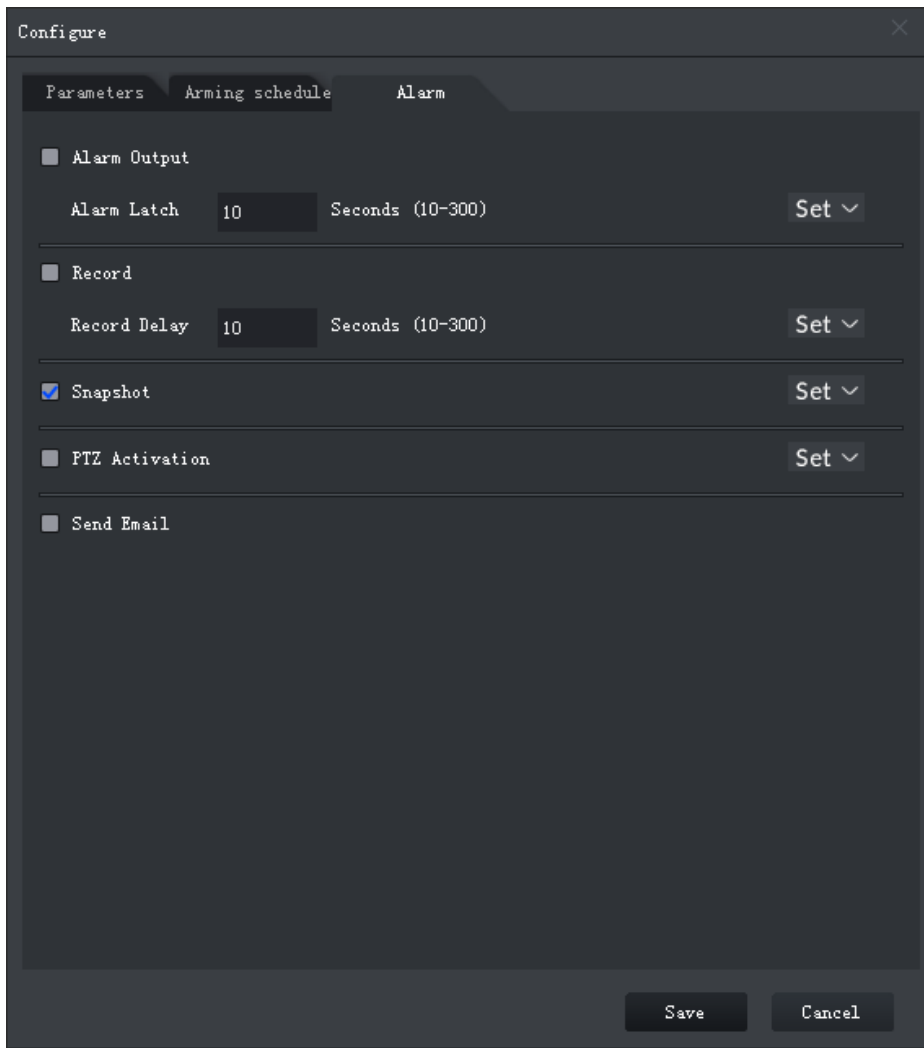



Figure 4-48

Parameter	Note	
Alarm output	Connect to alarm device (such as light and siren etc.), the system will transfer alarm info to alarm device when alarm is triggered.	Click Set to select alarm output channel.
Alarm latch	Alarm will continue a period of time after it is over.	
Record	The system logs in automatically when alarm is triggered.  Please enable auto record; otherwise it will fail to record.	Click Set and you can select recording channel.
Record delay	After alarm is over, it will continue to record for a period of time before stop.	
Snapshot	Capture picture when triggering alarm.  Please refer to 8 System Config for snapshot storage path query and setting.	Click Set and you can select snapshot channel.

Parameter	Note
PTZ activation	<p>Activate PTZ operation when triggering alarm.</p> <p>Click Set and select linkage mode, including preset, tour and pattern, meanwhile inputting corresponding number.</p>
Send email	<p>Send email to designated mailbox and inform users when face detection alarm occurs.</p> <p> Email can be successfully sent after Email setting is completed. For more config details, refer to 8 System Config</p> <p>None</p>

Chart 4-15

4. Click Save.

Step 5

Click Save to save config.

4.4.5 Heat Map

Make statistics about accumulated density of moving targets in the fixed scenario, distinguished by different colors, from blue to red. Blue means lowest heat value while red means highest heat value.

4.4.5.1 Enabling Heat Map

Step 1

Click **Next** after setting preset on the interface of **Scene Config**.

The interface of Smart Plan is displayed. See Figure 4-49.

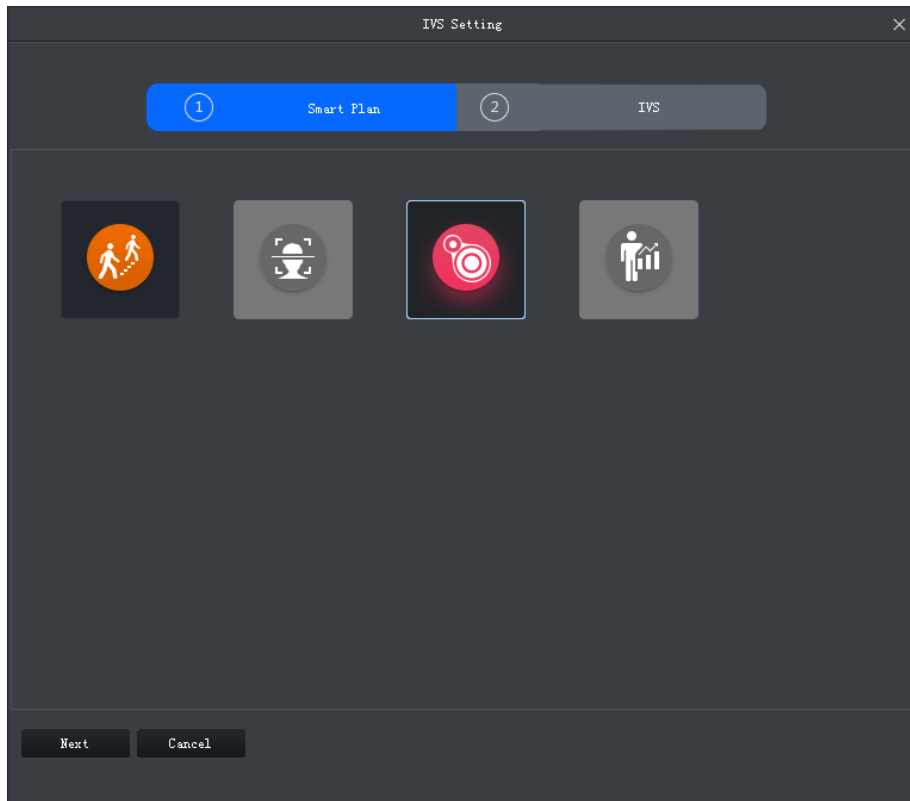



Figure 4-49

Step 2

Select scene according to requirement.

Step 3

Click  and select the smart plan of heat map.

The smart plan is selected when the white frame appears next to the icon. If you select other smart plans (mutually exclusive with heat map), first it needs to click corresponding icon to cancel selection, then click  to select smart plan of heat map.

4.4.5.2 Configuring Heat Map Rule

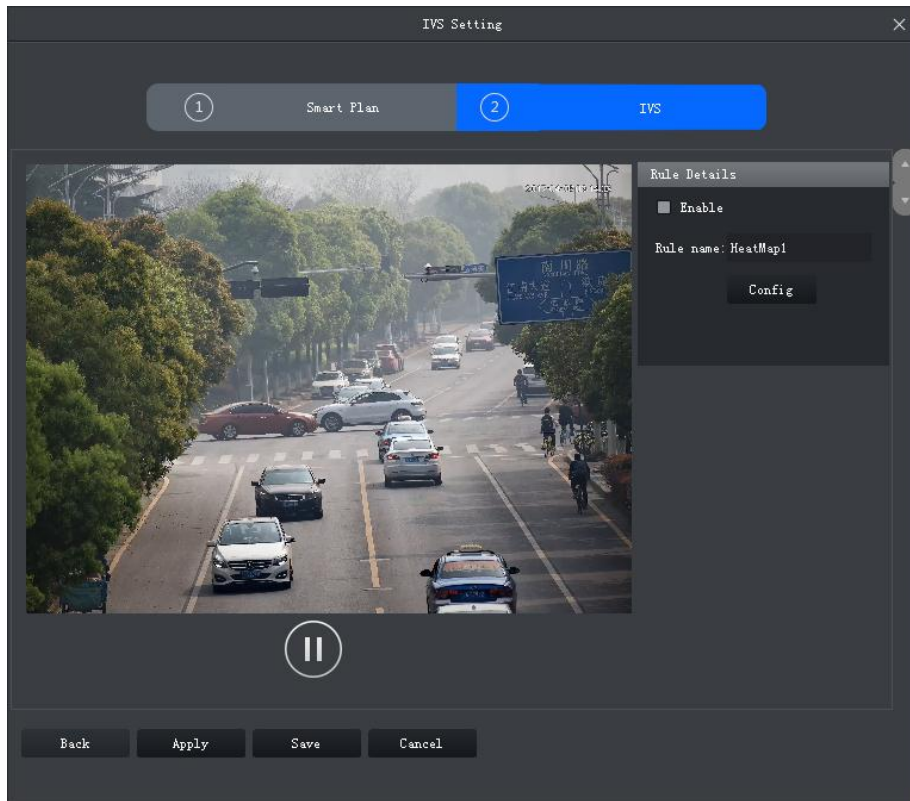

Figure 4-50

Step 1

Click **Enable**.

Step 2

Modify **Rule Name**.

Step 3

Configure arm period and alarm linkage.

1. Click Config.

The Config interface is displayed. See Figure 4-64.

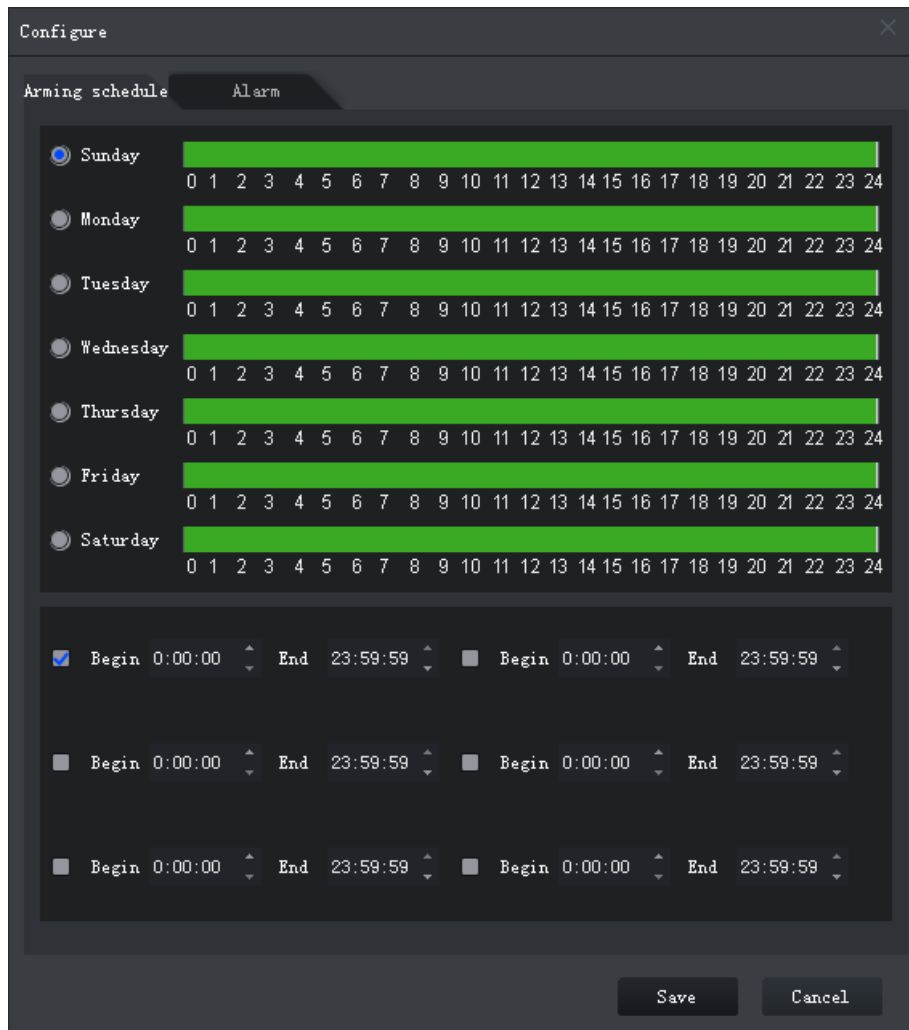

Figure 4-51

2. Click Arming Schedule, select week and period according to actual needs, input start time and end time.



The factory default time is 24 hours every day.

3. Click Alarm and set alarm linkage mode. See Figure 4-52. For more parameter details, see Chart 4-23.

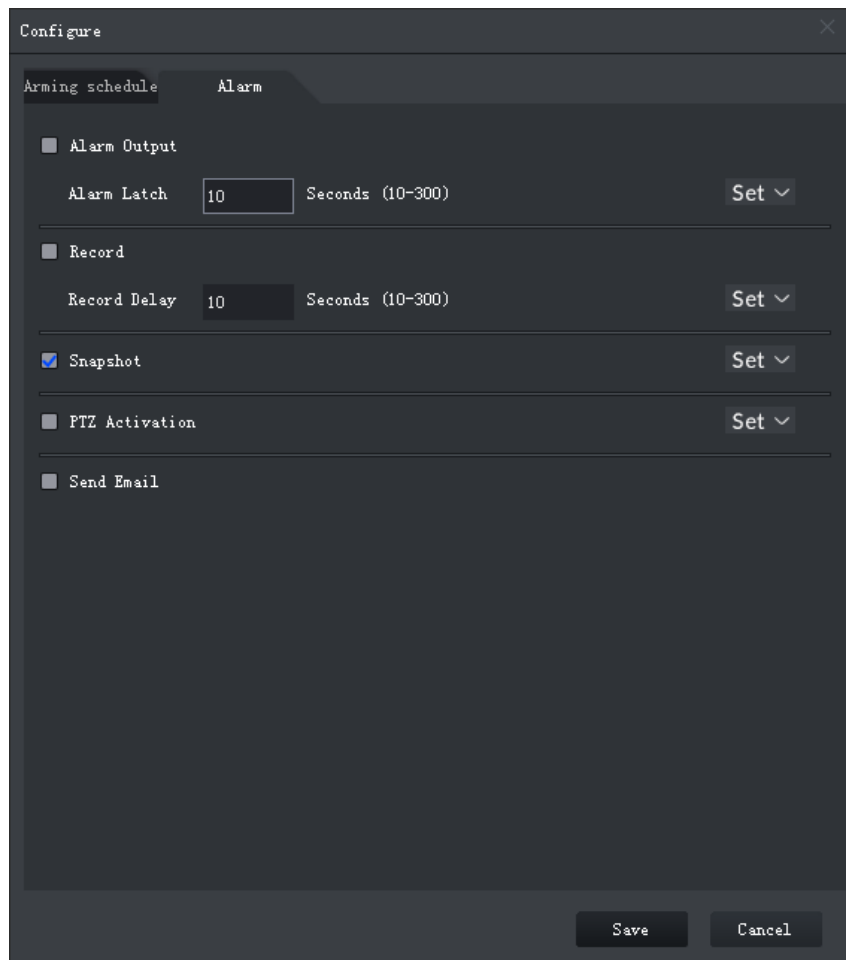



Figure 4-52

Parameter	Description	
Alarm output	Connect to alarm device (such as light and siren etc.), the system will transfer alarm info to alarm device when alarm is triggered.	Click Set to select alarm output channel.
Alarm latch	Alarm will continue a period of time after it is over.	
Record	The system logs in automatically when alarm is triggered.  Please enable auto record; otherwise it will fail to record.	Click Set and you can select recording channel.
Record delay	After alarm is over, it will continue to record for a period of time before stop.	
Snapshot	Capture picture when triggering alarm.  Please refer to 8 System Config for snapshot storage path query and setting.	Click Set and you can select snapshot channel.
PTZ activation	Activate PTZ operation when triggering alarm.	Click Set and select linkage mode, including preset, tour and pattern, meanwhile inputting corresponding number.

Parameter	Description	
Send email	Send email to designated mailbox and inform users when face detection alarm occurs.  Email can be successfully sent after Email setting is completed. For more config details, refer to 8 System Config	None

Chart 4-16

4. Click Save.

Step 4

Click Save and save config.

4.5 Smart Track Config (Fisheye+Dome)

Smart track (fisheye+dome) sets fisheye camera as master camera with panorama view, and sets speed dome as slave camera.

4.5.1 Calibration Requirement

To improve calibration success rate and accuracy, please follow:

- Calibrate at least 3 groups, max 10 groups. 4 groups is recommend.
- Start from far to close by clockwise or counterclockwise direction. Point of calibration shall be even.
- Calibrate position with obvious traits, such as cross of object corner.

See Figure 4-53 and Figure 4-54.



Figure 4-53



Figure 4-54

4.5.2 Calibrating Camera

Step 1

On device tree select fisheye device, right click select Smart Track Config, see Figure 4-55.

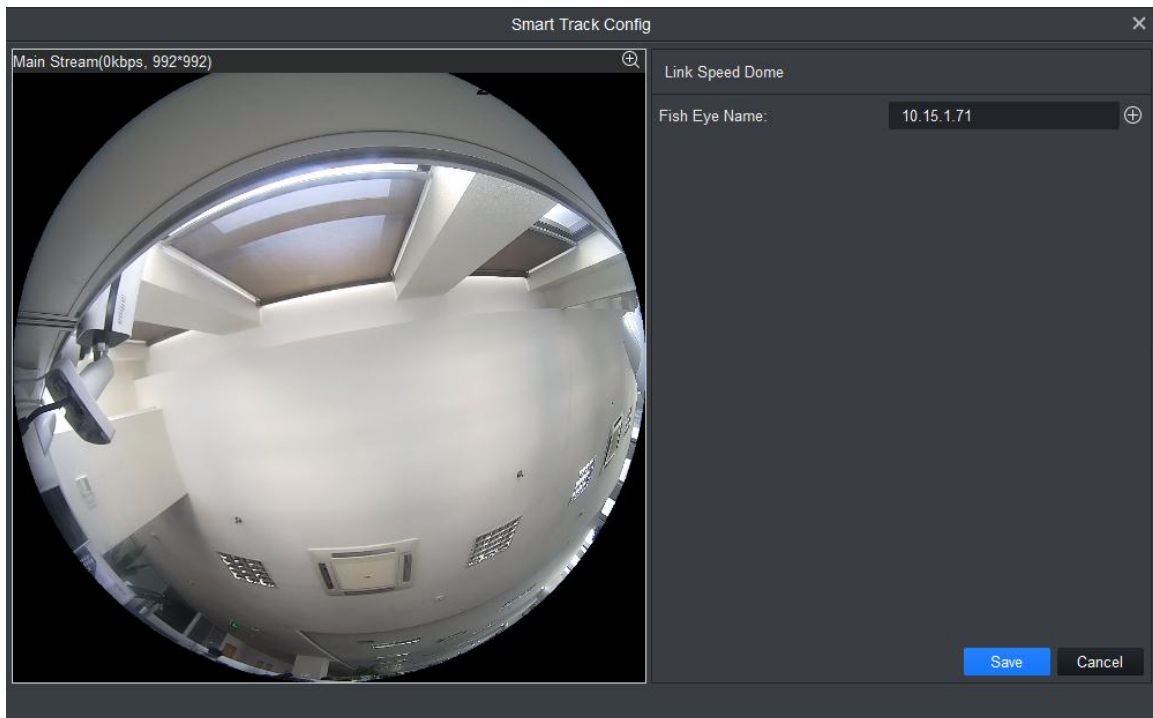

Figure 4-55

Step 2

Associate speed dome. See Figure 4-56.

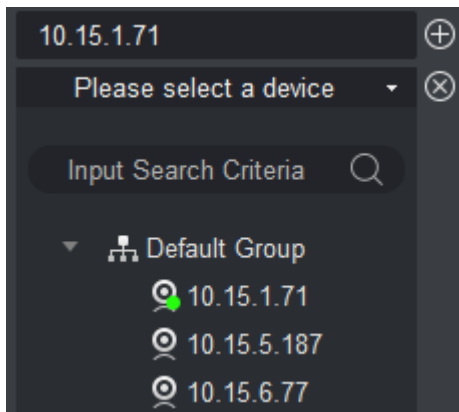

Figure 4-56

1. In Link Speed Dome area, click  next to fisheye name.
2. In speed dome dropdown list, select speed dome.
3. Click Save. See Figure 4-57.



Figure 4-57

Step 3

Add calibration point.

1. Click Add, you will see a cross sign and a new record generated.
2. Drag fisheye cross sign to appropriate position.



- To improve calibration accuracy, please use far object as reference for first group. Other calibrations points can be clockwise or counterclockwise distributed.
- Calibrate position with obvious traits, such as cross of object corner.

- In speed dome image, adjust speed dome position to make center of speed dome match the cross sign of fisheye. See Chart 4-17.







Icon	Name	Note
	Zoom	Zoom in/out speed dome
	Focus	Adjust speed dome focus
	Iris	Adjust speed dome brightness
	E-mouse	Electronic mouse
	Quick Position	Click this icon, drag mouse in monitoring video, select area, then video is automatically adjusted by making pane as center.

Chart 4-17

- Click  to save calibration info.
- Repeat step 1~4 to complete remaining calibration position. N
- Click OK.
- Click OK to save config.

Fisheye and speed dome are calibrated successfully if there is no feedback info; It will generate tips "Calibration failed, please calibrate again" if calibration failed.

4.5.3 Achieving Smart Track (Fisheye and Dome)

After you complete calibration, you can view link effect in smart track interface.

Step 1

On device tree, select fisheye device, right click Smart Track. See Figure 4-58.

- By default link mode is enabled, click  and you can switch between fisheye correction mode and link mode. To enable fisheye correction, you can select installation method and view mode in fisheye preview window. Refer to **4.9 Fisheye View Mode**
- On the left you can set PTZ, refer to 4.8 PTZ

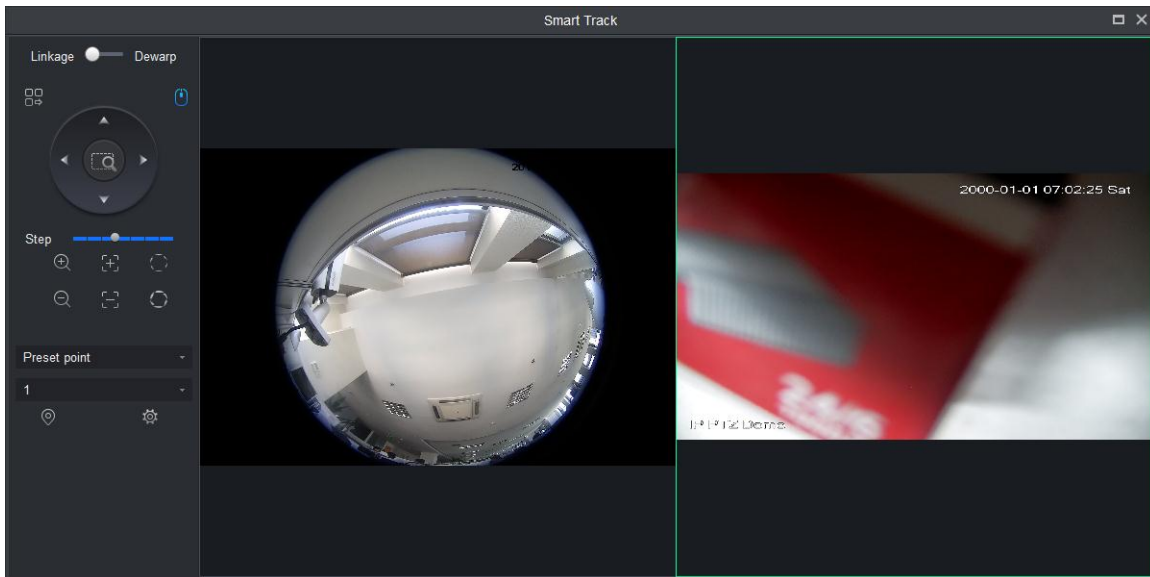

Figure 4-58

Step 2

Execute the following operation to see link effect.

- Link

Click any position in fisheye channel, speed dome will rotate to corresponding position and auto adjust zoom, see Figure 4-59.

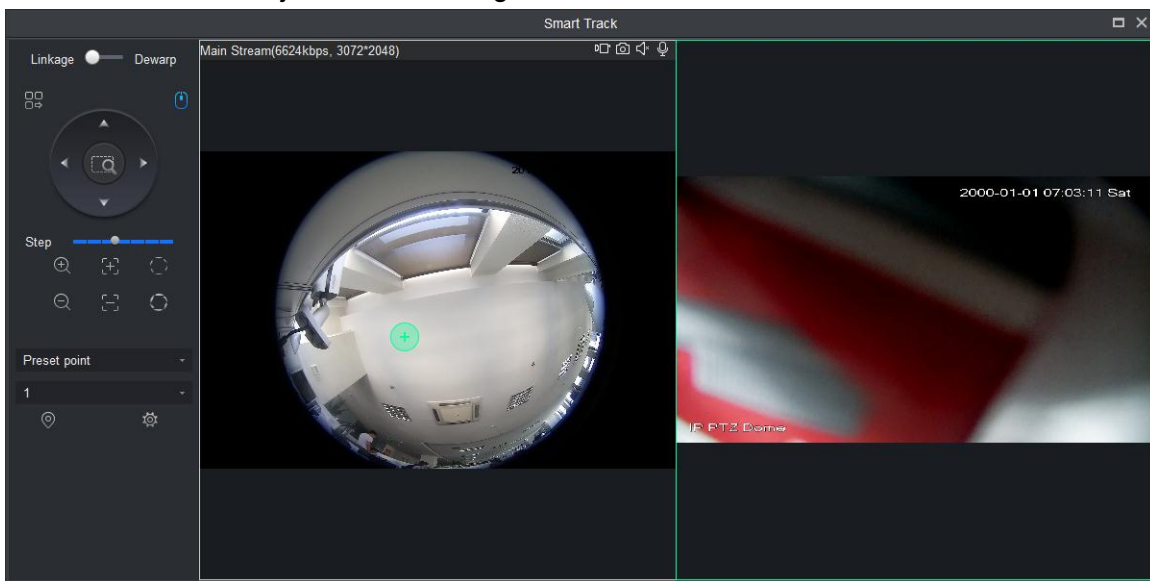

Figure 4-59

- Box link

Select box in fisheye video, speed dome rotates to corresponding area, see Figure 4-60.

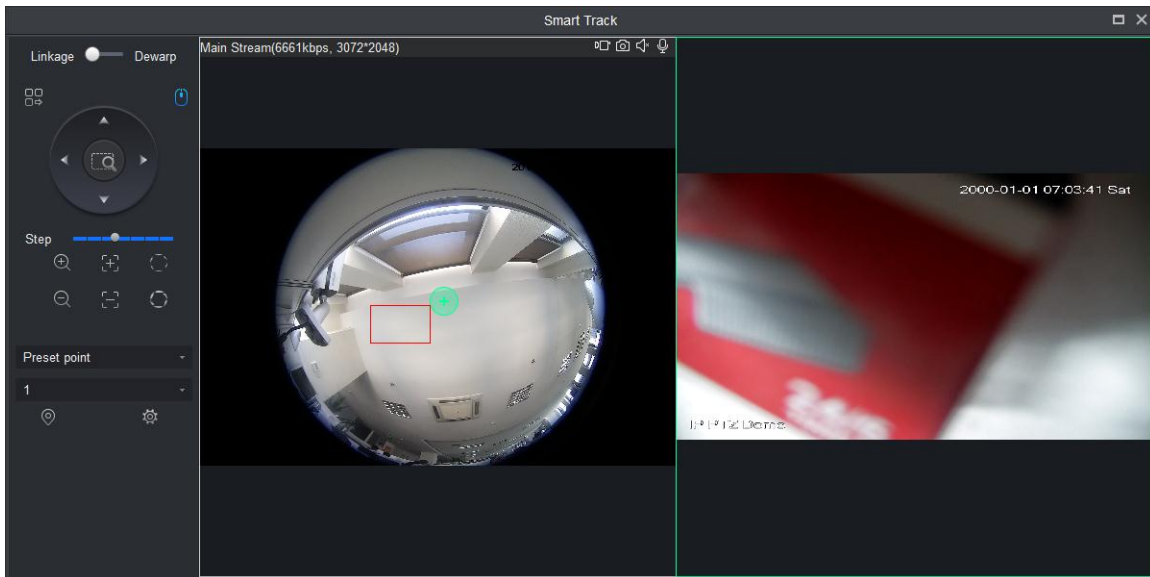

Figure 4-60

- Drag link

Drag position calibration in fisheye video, speed dome rotates with the calibration, see Figure 4-61.

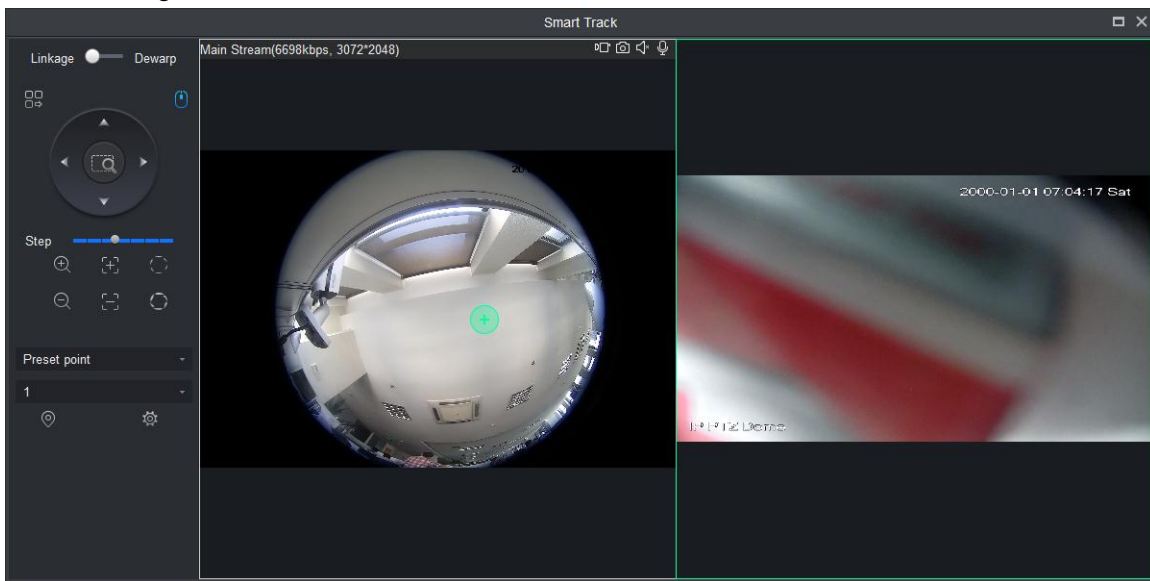

Figure 4-61

4.6 Smart Track Config (Dome+Bullet)

After you have configured dome and fixed camera linkage, when intelligent rule of fixed camera triggers alarm, speed dome auto links to corresponding position and tracks object until the object exceeds monitor range or tracking time limit.

4.6.1 Calibration Requirement

To improve calibration success rate and accuracy, please follow:

- Calibrate at least 4 groups, max 8 groups. 4 groups are recommended. The spots are recommended to be evenly distributed in the scene. It is not recommended to

lay three or more spots on the same straight line.

- Start from far to close by clockwise or counterclockwise direction. Point of calibration shall be even.
- Calibrate position with obvious traits, such as cross of object corner.

See Figure 4-62.



Figure 4-62

4.6.2 Calibrating Camera

Step 1

Select fixed camera on device tree, right click Start Track Config. See Figure 4-63.

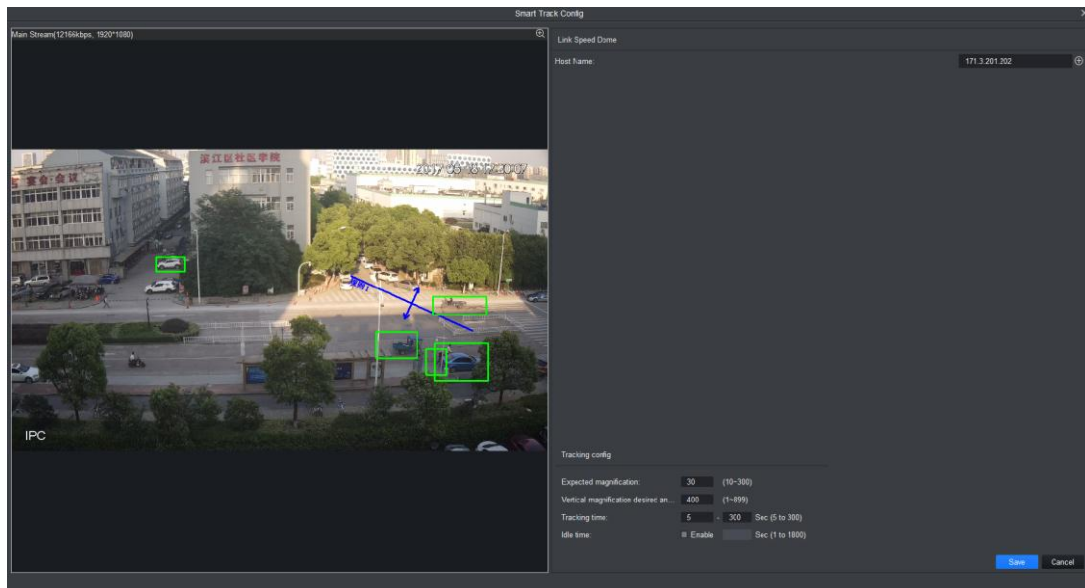

Figure 4-63

Step 2

Associate speed dome, see Figure 4-64.

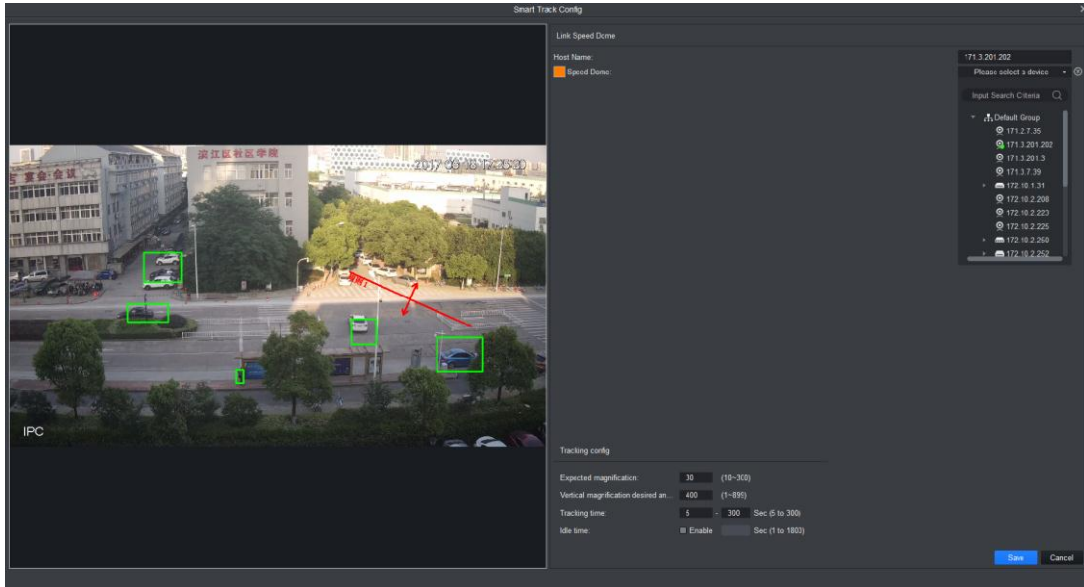



Figure 4-64

1. In link speed dome area, click .
2. Click  and in dropdown list select speed dome.
3. Set tracking config, see Chart 4-18.

Parameter	Note
Expected magnification	Link speed dome tracking magnification.
Vertical magnification desired angle	Link speed dome vertical magnification desired angle.
Tracking time	Support setup of upper limit and lower limit. If tracking reaches min limit, current tracking can be interrupted. If a new target appears, it will track new target. If tracking reaches max limit, tracking end.
Idle time	Select Enable, enable idle time and then when there is no target in fixed camera and reaches set time, speed dome returns to preset point.

Chart 4-18

4. Click Save, see Figure 4-65.

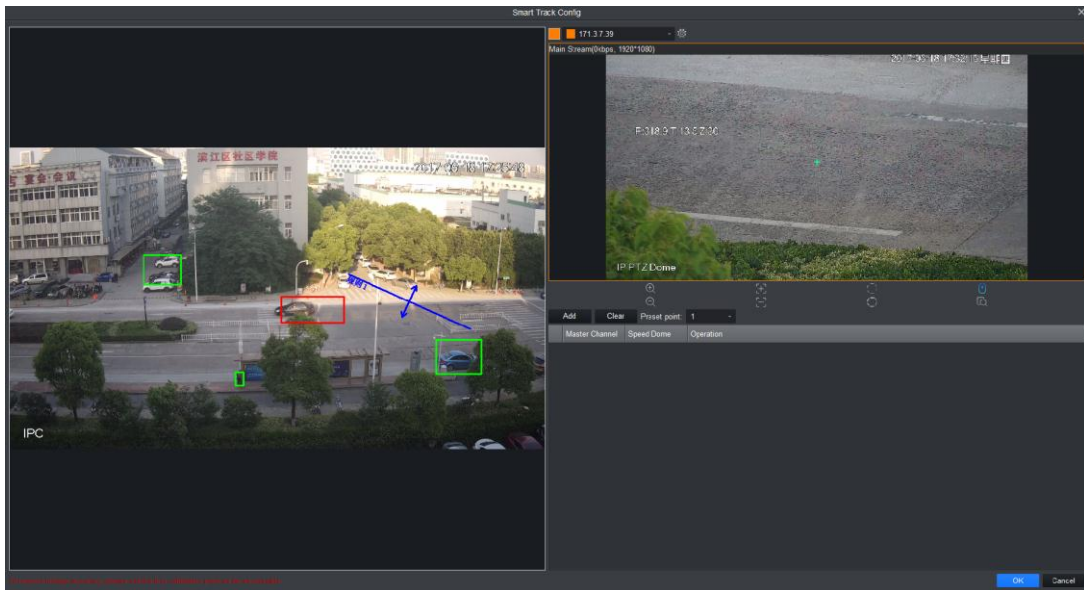

Figure 4-65

Step 3

Calibrate fixed and dome, see Figure 4-66.

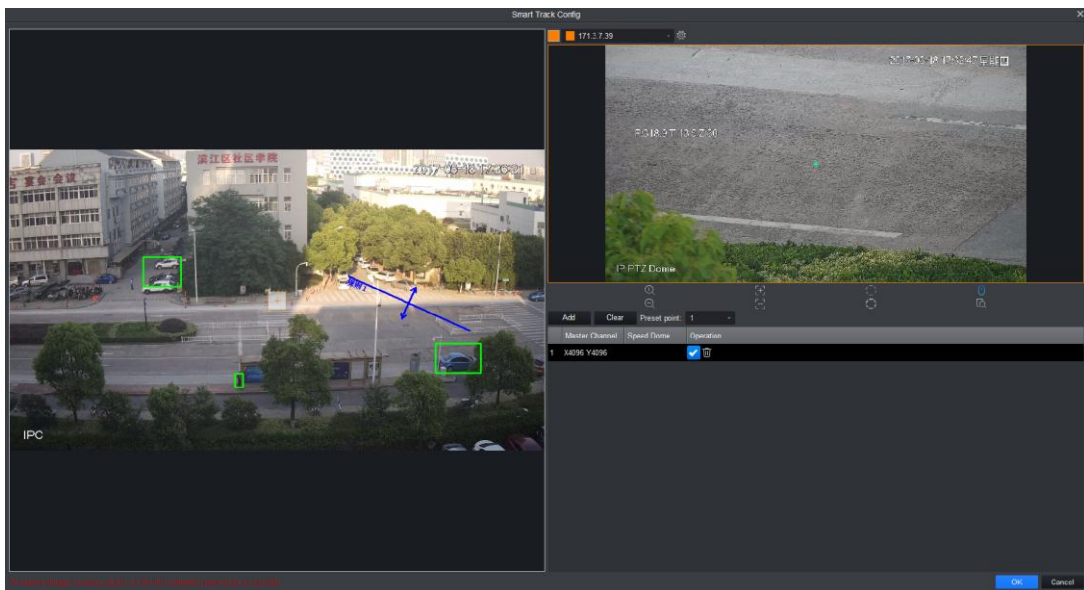

Figure 4-66

1. Click Add, a cross appears in video and meantime a record is generated.
2. Drag cross to appropriate position.



- Start from far to close by clockwise or counterclockwise direction. Point of calibration shall be even.
 - Calibrate position with obvious traits, such as cross of object corner.
3. In video of speed dome, adjust speed dome position via icon below to make center of speed dome match + in fixed camera video.

Icon	Name	Note
------	------	------







Icon	Name	Note
	Zoom	Zoom in/out speed dome
	Focus	Adjust speed dome focus
	Iris	Adjust speed dome brightness
	E-mouse	Electronic mouse
	Quick Position	Click this icon, select any position to monitor, then you can adjust image with this position as center.

Chart 4-19

4. Click  to save calibration info.
5. Repeat step 1~4, complete remaining calibration config.



Each speed dome calibrates at least 4 groups, max 8 groups. 4 groups are recommended.

6. Select preset return point.
When fixed camera video has no tracking to reach set length, speed dome can return to set preset.
7. Click OK, to save.
Successfully calibrated fixed camera, and system feedbacks. If failed, it will inform calibration failed and please try again.

4.6.3 Achieving Smart Track (Bullet and Dome)

After you complete calibration, you can view link effect in smart track interface.

Step 1

On device tree, select IPC device, right click Smart Track. See Figure 4-67.

On the left you can set PTZ, refer to 4.8 PTZ.

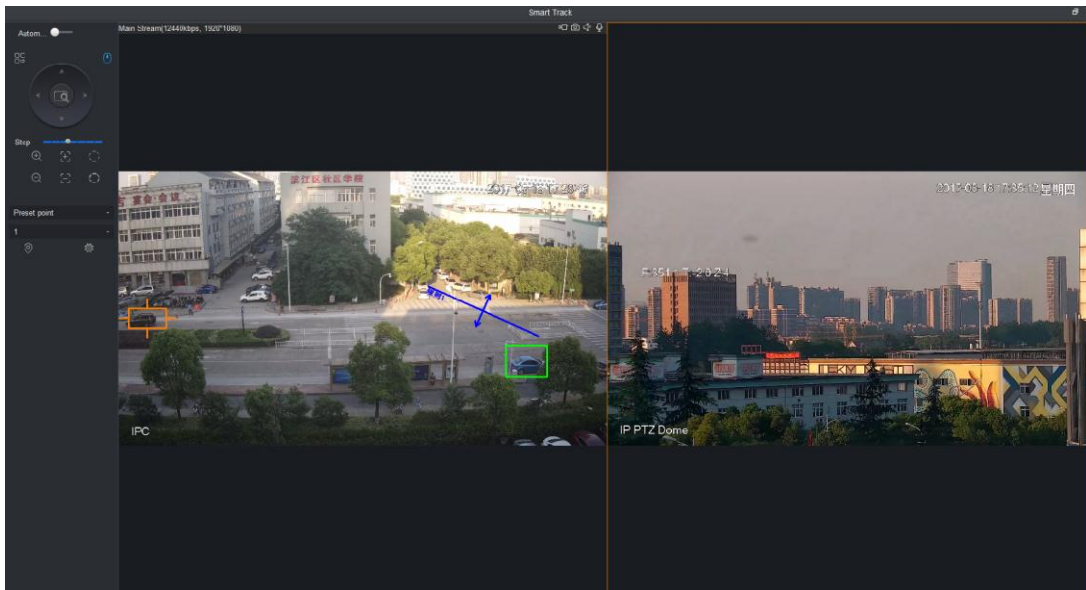

Figure 4-67

Step 2

Execute the following operation to see link effect.

- **Manually position**

Click any position in fixed camera video, link to speed dome. Speed dome will rotate to the corresponding position, see Figure 4-68.



Figure 4-68

- **3D Position**

In fixed dome video pane select, speed dome will rotate to corresponding area and meantime zoom in/out.

Draw box from upper left to lower right, and zoom in when speed dome is fixed, see

Figure 4-69.

Draw box from lower right left to upper left, and zoom in when speed dome is fixed, see Figure 4-70.



Before



After

Figure 4-69



Before





After

Figure 4-70

- Manually track



- ✧ The precondition of manual tracking is that smart config is already set on the bullet. For setting details, see **4.4.2 General Behavior Analytics**. After smart config is completed, it will display moving target box when there is moving target in the picture.
- ✧ In order to make sure that manual track is accurate, you can click  at the upper right corner of Smart Track interface to disable auto track, and the icon will be displayed as  after it is disabled.



Click moving target box (effective inside the box) in the monitoring image of bullet, the box color is changed, and the speed dome will select target.



Figure 4-71

- Auto Track



For auto tracking, it needs to set smart config of bullet in advance. For setting details, see 4.4.2 General Behavior Analytics. Click  at the upper right corner to enable auto tracking, the icon will become  after it is enabled. The speed dome will automatically track target when there is target triggers tripwire or intrusion. See Figure 4-72.



For setting of tracking duration, see 4.6.2 Calibrating Camera



Figure 4-72

- Return to Preset

Enable idle return to preset during calibration, in any status, if there is no target triggering track in the bullet picture during the period, then the speed dome picture will return to the designated preset.

4.7 Smart Tracking (Smart Capture System)

The smart tracking interface of smart capture system supports viewing reported faces, human body and vehicle properties.



It is required to configure target detection smart plan over the smart capture system and enable human body and vehicle target detection if realizing viewing faces, human body and vehicle properties by SmartPSS.

Step 1

Unfold channel on the device tree, right click channel and select Smart Tracking.

The interface of Smart Tracking is displayed.

Step 2

Click  and enable property report.

It is enabled when it shows blue. After it is enabled, the device can detect face, human body and vehicle, and then report them to SmartPSS. See Figure 4-73.

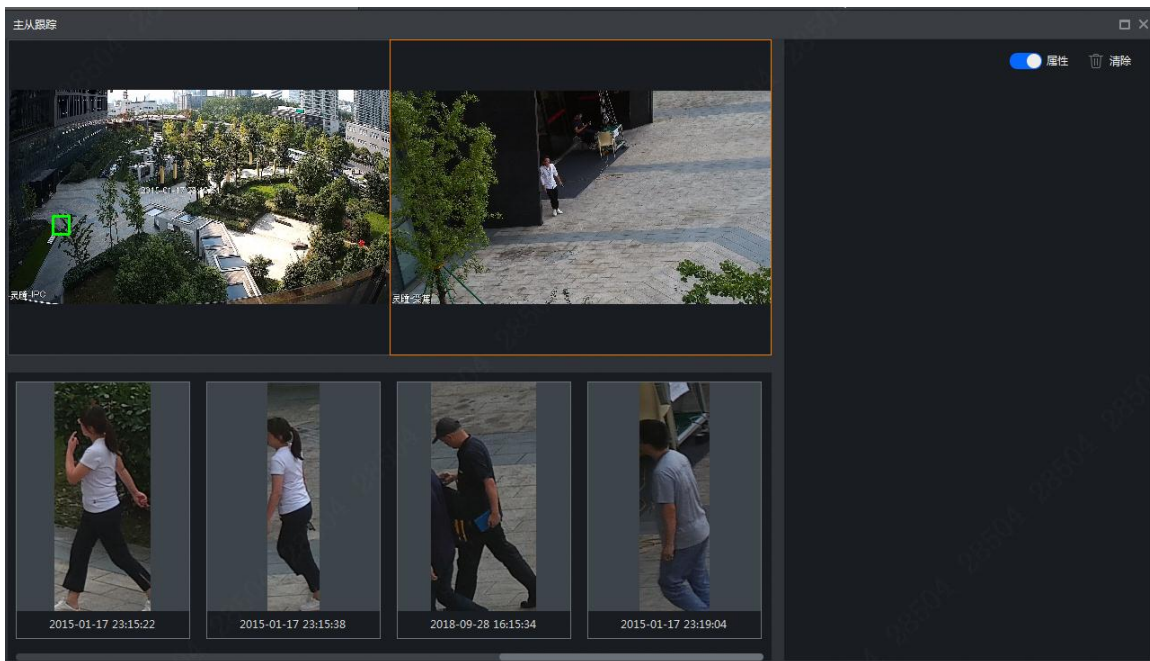

Figure 4-73

4.8 PTZ

PTZ of different devices have different setup interfaces, subject to actual condition. See the following figures and charts.

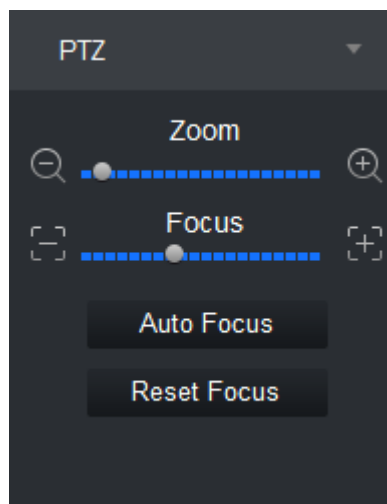

Figure 4-74

Parameter	Note
Zoom	Click or to adjust zoom.
Switch to PTZ	Click Switch to PTZ, system jumps to PTZ control.
Focus	Click or to adjust definition.
Auto Focus	Click Auto Focus to auto focus.

Reset Focus	Click Reset Focus to reset.
-------------	-----------------------------

Chart 4-20

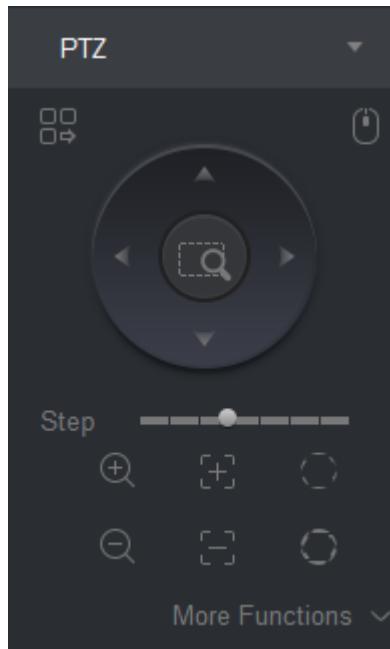











Figure 4-75

Parameter	Note
Menu	Click  and go to PTZ menu.
Mouse stimulation	Click  , via mouse operate PTZ.
Direction	Set PTZ direction in 4 directions.
3D position	Click  , and draw a box in video monitoring, PTZ will rotate and focus to this scene.
Step	Control PTZ rotation speed, can be set 1 to 8 different rotation steps.
Zoom	Click  or  to adjust zoom.
Focus	Click  or  to adjust definition.
Iris	Click  or  to adjust brightness.
Preset	By setting the Preset, you can quickly go to the preset position corresponding to the camera. Preset setting For details, see 4.8.1 Preset  You can set up to 128 presets.



Parameter	Note
Tour	By setting Cruise, the camera can cruise between different preset points. Cruise setting details, see 4.8.2 Tour  You can set up to eight cruise group.
Horizontal rotation	By setting Horizontal rotation, the camera can be rotated horizontally. In  , Select Horizontal rotation and click  , turn on horizontal rotation.
Scan	By setting the two borders, the camera rotates repeatedly between the two borders. Scan settings For details, see 4.8.3 Scan
Pattern	By setting the Tour track, the user operation during the rotation of the camera recorded, the camera can be rotated according to the track record. Patrol track setting details, see 4.8.4 Pattern
AUX	With aux, aux commands can be entered to turn on the aux points.
Windshield wiper	Click  to control wiper.

Chart 4-21

4.8.1 Preset

By setting the preset point, you can quickly go to the preset position corresponding to the camera.

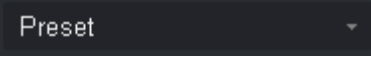
Step 1

Via PTZ direction control the camera to designated position.

Step 2

In  select preset, click .

Step 3

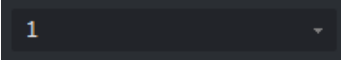
In  select preset no., enter preset name.

Step 4

Click  to save preset.

Step 5

Click  to delete non-necessary preset.

Step 6

Select preset and click , camera rotates to corresponding position.



4.8.2 Tour

By setting the tour, the camera can tour between the different preset points.



Set at least two presets before you can tour.

Step 1

In , select tour, and click . See Figure 4-76.

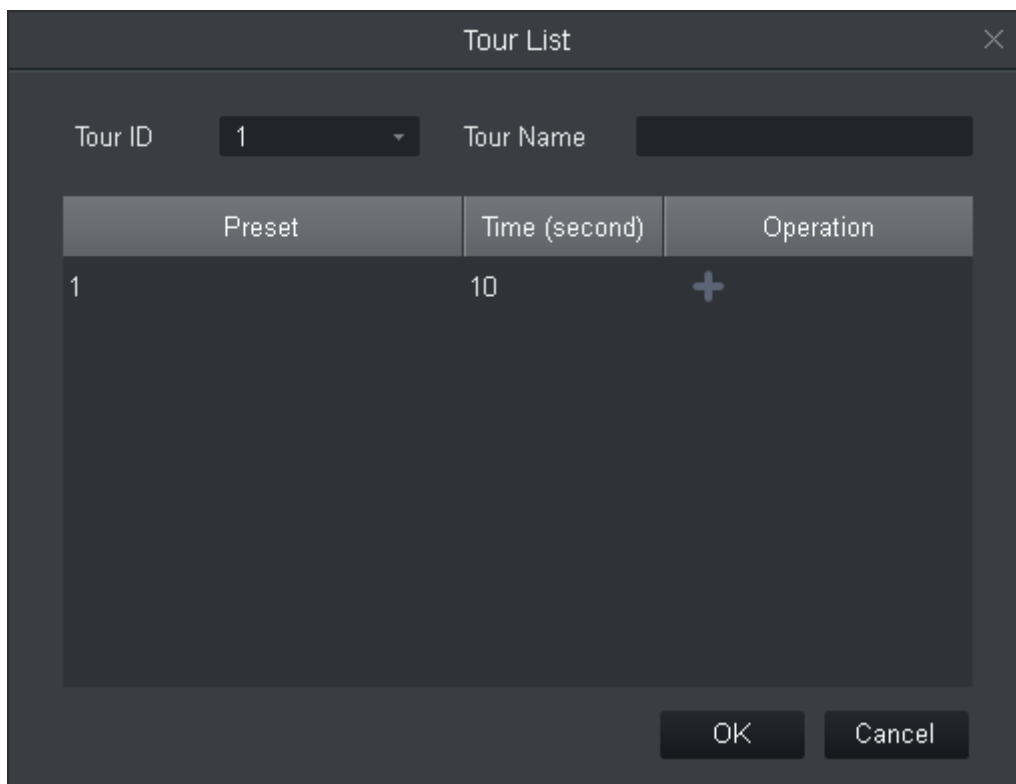

Figure 4-76

Step 2

Set tour no. and tour name.

Step 3

Select preset.

✧ In Preset list select preset, and enter time.

✧ Click  to add preset.

Repeat this step to add more presets.

Step 4

Click **OK**.

Step 5

You need to select tour no., click  so camera will tour among different presets.

4.8.3 Scan

By setting the two borders, the camera rotates repeatedly between the two borders.

Step 1

In  select Scan.

Step 2

By control PTZ direction, rotate PTZ to designated left position, click  to set left border.

Step 3

By control PTZ direction, rotate PTZ to designated right position, click  to set right border.

Step 4

Click  to repeat rotation among two borders.

4.8.4 Pattern

Record down camera rotation process, via pattern rotation function.

Step 1

In  select Pattern.

Step 2

Click  to start to set pattern, and zoom, focus or rotate camera.

Step 3

Click  to complete.

Step 4

Select pattern no., click , and camera rotate pattern according to record.

4.8.5 Enabling Windshield Wiper

When speed dome has windshield wiper, SmartPSS can control windshield wiper.

Step 1











In  select wiper.

Step 2

Click  to wipe speed dome once.

4.9 Fisheye View Mode

Only fisheye device supports installation and view mode, different installation modes corresponding to view mode referring to the following chart.

parameter	Description	
View mode	<p>Current video screen (by default support the original image mode), in accordance with the different installation methods, with other different presentation as follows:</p> <ul style="list-style-type: none"> • Ceiling: 1P + 1, 2P, 1 +2, 1 +3, 1 +4, 1P +6, 1 +8. • Wall mount: 1P, 1P + 3, 1P + 4, 1P + 8. • GND: 1P +1, 2P, 1 +3, 1 +4, 1P +6, 1 +8. <p> When switching installation mode, by default show the original image mode.</p>	
Ceiling/wall mount/GND	 original image	That is the original image has not been corrected.
Ceiling	 1 + 2	That is the original video +2 independent sub videos and the sub-frame in sub video and original image support zoom, move.
Ceiling/ wall mount	 1P + 1	As 360 ° rectangle panoramic + independent sub video, and sub-frame in sub video and original rectangle panoramic support zoom, move. Rectangle panoramic also supports move of left/right starting point.
	 2P	As two linked 180° rectangle video, at any moment the two windows form a 360° panorama, as “dual panorama”. Two rectangle video both support move of left/right starting point and link each other.
	 1 + 3	As original image +3 independent sub videos and the sub-frame in sub video and original image support zoom, move.
	 1 + 4	As original image +4 independent sub videos and the sub-frame in sub video and original image support zoom, move. Original video also support move of left/right starting point.
	 1P + 6	As 360 ° rectangle panoramic +6 independent sub videos, and sub-frame in sub video and original rectangle panoramic support zoom, move. Rectangle panoramic also supports move of left/right starting point.
	 1 + 8	As original image +8 independent sub videos and the sub-frame in sub video and original image support zoom, move.
Wall mount	 1P	As 360° rectangle panorama from left to right, 180° rectangle panorama support up/down move to change to vertical view.
	 1P + 3	As 360° rectangle panorama +3 independent sub video, and the sub-frame in sub video and original image support zoom, move. Rectangle panorama support up/down move to change to vertical view.



	 1P + 4	As 360° rectangle panorama +4 independent sub video, and the sub-frame in sub video and original image support zoom, move. Rectangle panorama support up/down move to change to vertical view.
	 1P + 8	As 360° rectangle panorama +8 independent sub video, and the sub-frame in sub video and original image support zoom, move. Rectangle panorama support up/down move to change to vertical view.

Chart 4-22

4.10 Device Preview via NKB1000 Keyboard

Via NKB1000 keyboard, you can enable device preview, split preview window, control PTZ, close preview video and etc.

Condition

- Set and record device no. of device to be operated.
- Keyboard connected PC where SmartPSS is installed.
- Logged in SmartPSS interface and open preview.

Step 1

Connect keyboard, power indicator is ON. After it is running, LCD shows welcome interface. Click OK or Set key.

Step 2

Via rocker, enter username and password, click OK. It shows homepage.



Admin user has default password as 888888.

Step 3

Via rocker, left/right select mode to be preview, and click OK.

Step 4

Operate preview interface, see Chart 4-23.

Function	Note
Split Window	Click 【window number】 , and then click 【split】 to split windows. Window number of number of split.
Enable Preview	By sequence of 【window no.】 and 【ID】 key, select preview window and then click 【device no.】 and 【channel】 key to enable corresponding preview video of device. Window no. is 1 at upper left corner, starting from left to right, up to down.
Close Preview	Click 【window no.】 and 【ID】 key respectively. Select window in preview, and click 【0】 and 【channel】 key. Close corresponding preview video. Window no. is 1 at upper left corner, starting from left to right, up to down.
PTZ Control	Enable speed dome video preview and keyboard in being operated. You can control speed dome direction, adjust it is, focus, zoom and etc.

	<ul style="list-style-type: none">● Via rocker, rotate in up, down, left, right, up left, up right, down left and down right directions.● Click 【iris】 + or -, adjust iris.● Click 【zoom】 + or -, adjust video definition.● Click 【zoom】 + or -, adjust zoom.
--	---

Chart 4-23

5. Tour & Task

5.1 Config Task Plan

By setting tour plan, you can tour each window.

Step 1

Click , and click Tour & Task.

Step 2

Add tour plan.

1. Click Add. See Figure 5-1.

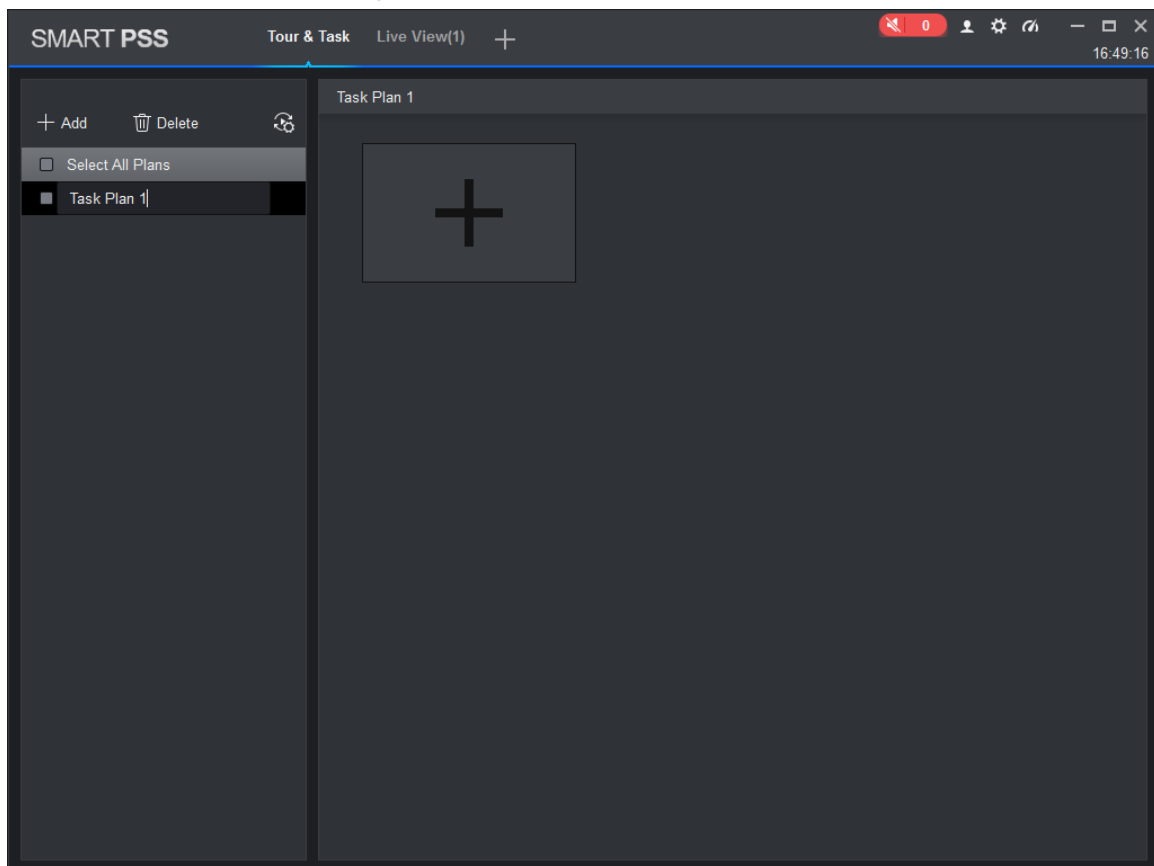

Figure 5-1

2. Modify task plan name.

When you add new task, you can edit task name immediately. Or you can double

click tour plan name or click  to modify tour plan name.

Step 3

Set task. It supports to set multiple tasks. Here takes one task as example.

1. Click . See Figure 5-2.

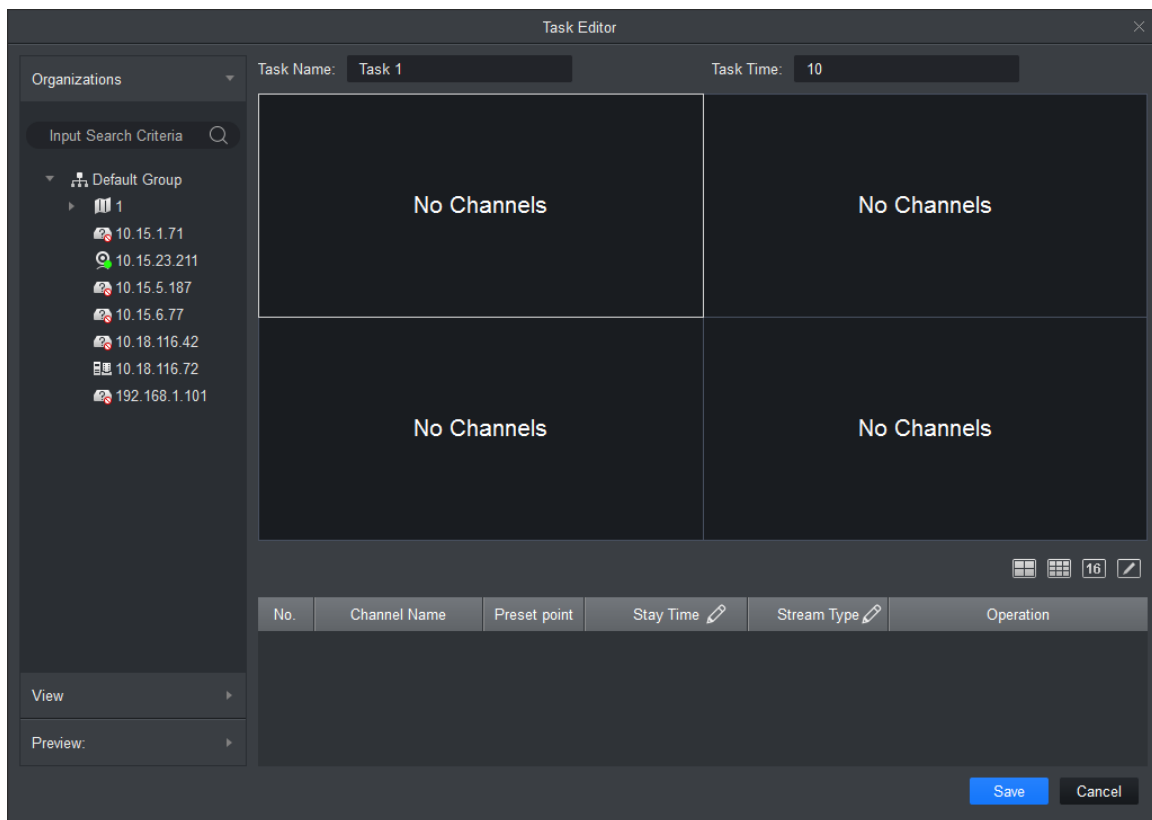

Figure 5-2

2. Set task name and time span, according to actual condition click



to set four window number.

3. Double-click the channel of the device or drag the channel of the device into the video window in the order that you want. See Figure 5-3.



- In the Organization Tree, right-click a storage device, select the Bind all channels, the storage channel in turn is bound to the corresponding video window ; select the video window to be bound in the Organization Tree, right-click a storage device, select the tie given zero channels zero bound channel to the selected video window.
- Select the video window to be bound, under the Organization Tree, right-click the channel storage devices, select the Bind channel, the channel will be bound to the selected video window.
- Select Bind video window, right-click the organizational tree in the front-end device, selects the Bind IPC, the front-end device bind to the selected video window.
- After the video channel bonding, right-click the video window, remove binds or remove all binds.

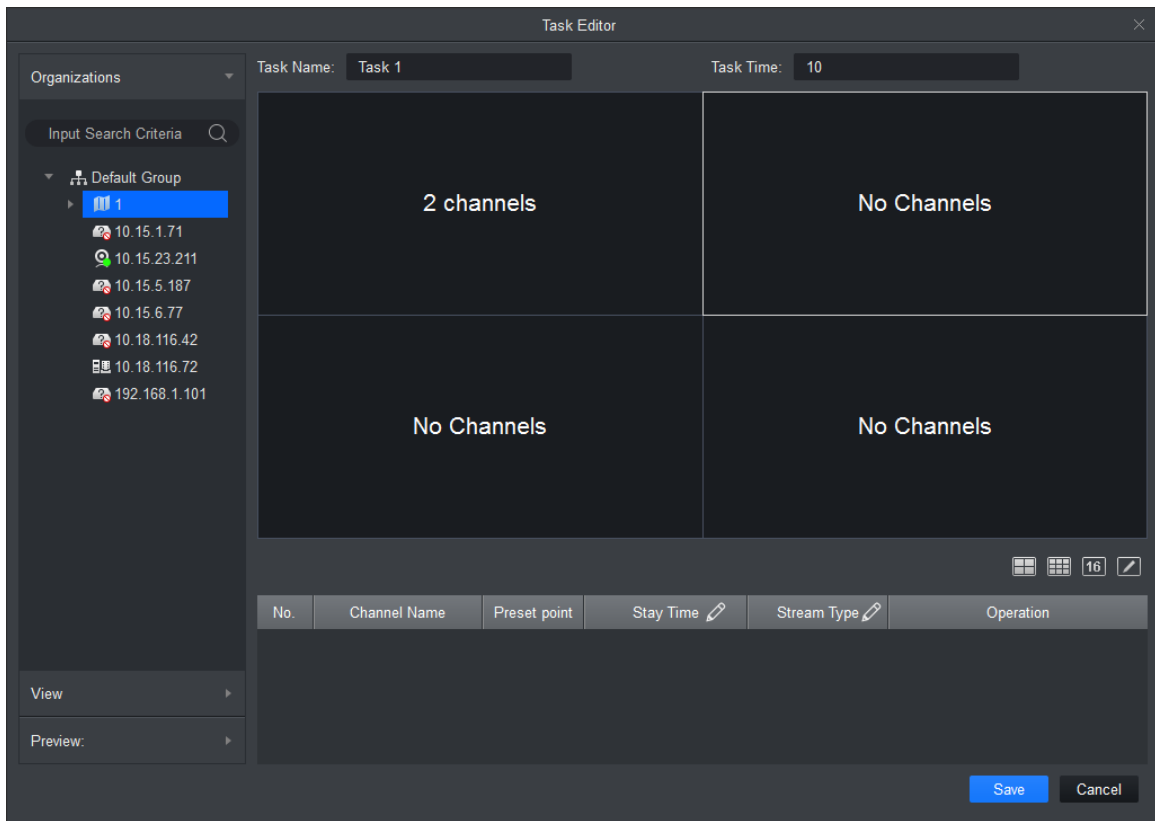





Figure 5-3

4. Set channel preset, time span, stream type and channel sequence.



- Click  of the corresponding channel, in the left preview screen to display live preview or e-map information.
- Click  or  of the corresponding channel, adjust the channel sequence in the task.
- Click  of the corresponding channel, delete the corresponding channel.

5. Click Save, See Figure 5-4.

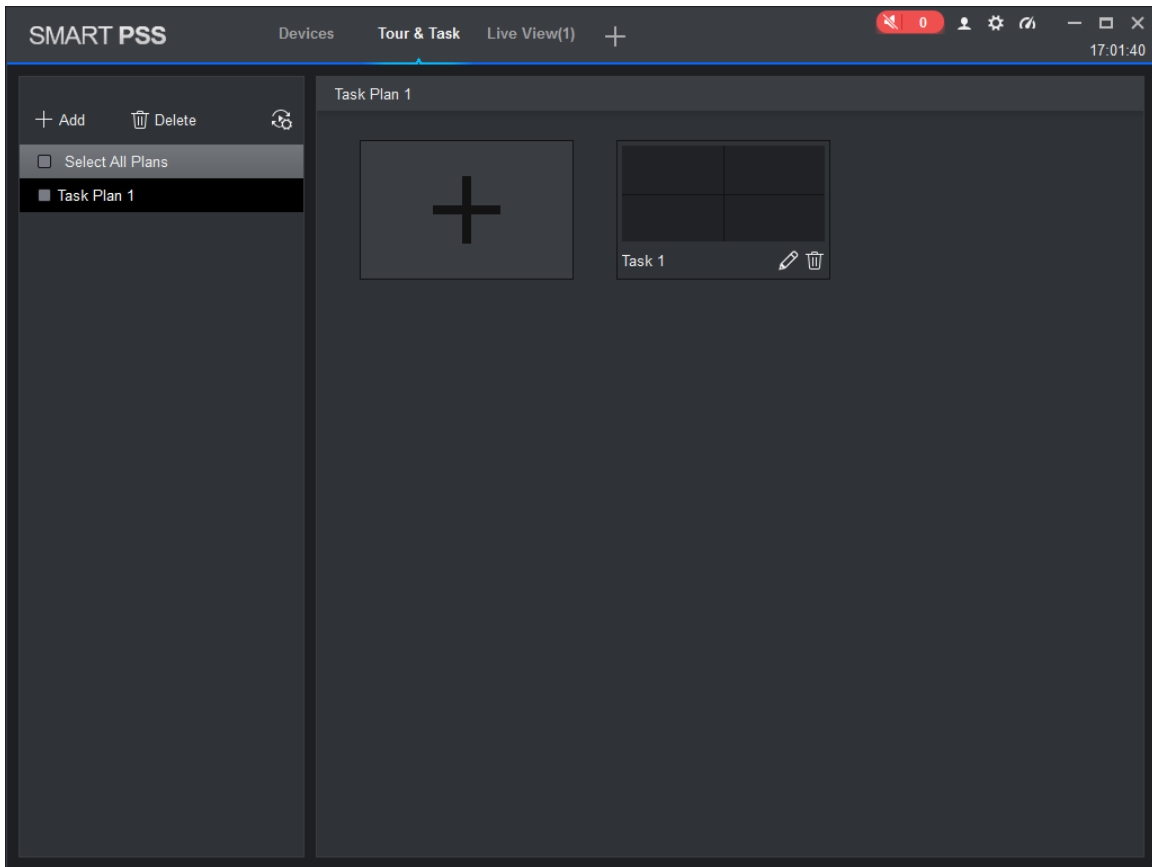



Figure 5-4

Step 4

Set tour task.

When you set multiple tasks, it support task plan by day or week.

1. Click  to run the plan. See Figure 5-5.

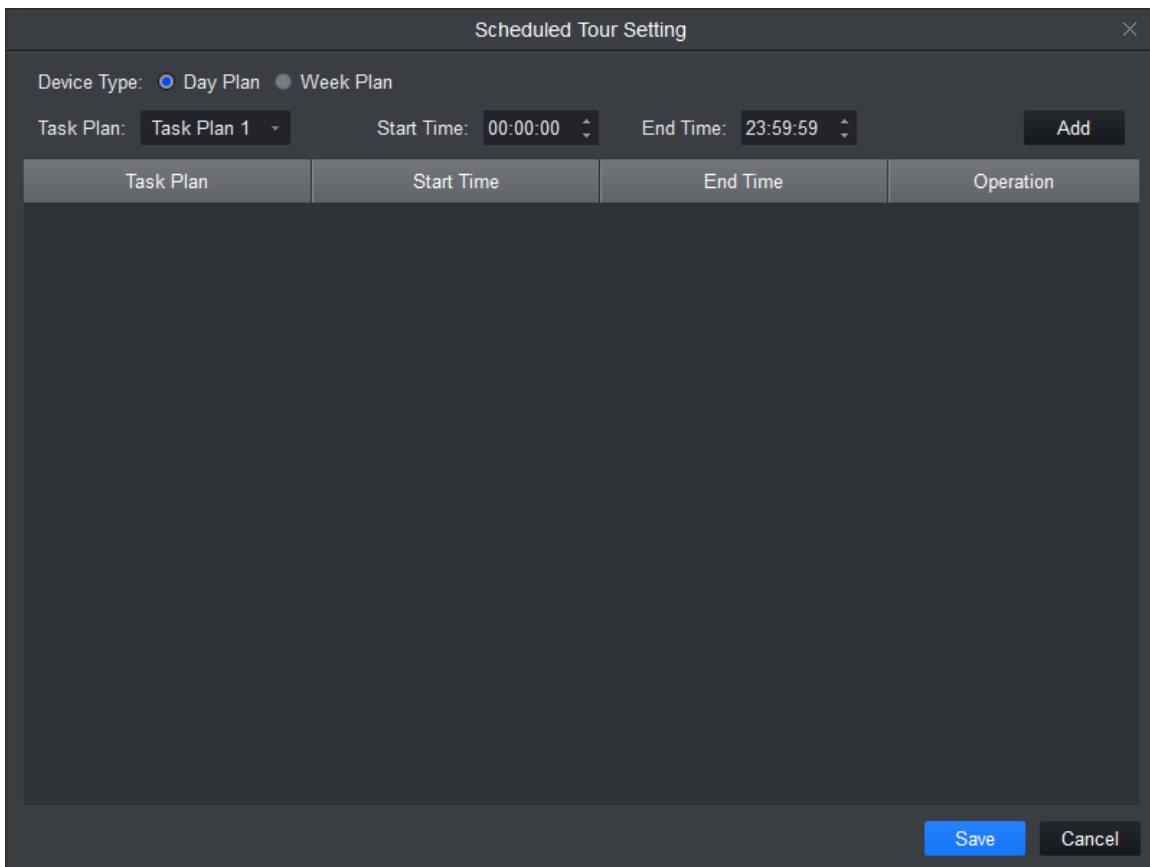

Figure 5-5

2. Select device type.
 - Day plan, period is day. There are many different periods in a day.
 - Week plan. There are 7 periods in a week.
3. Select tour plan, set time, and click Add.
4. Set different period task, click Save.

5.2 Enabling Task

If your device sets schedule, then within set time system will auto plays video according to task. If you want to manually tour, priority of manual task must be over scheduled task.

Step 1

In New function tab, click Live View.

Step 2

In the interface, select tour plan.

Step 3

Click  to enable task plan.

6. Playback

6.1 Playback

You can playback and export device record, device picture, local record and local picture.

In New tab, click  select Playback, see Figure 6-1.

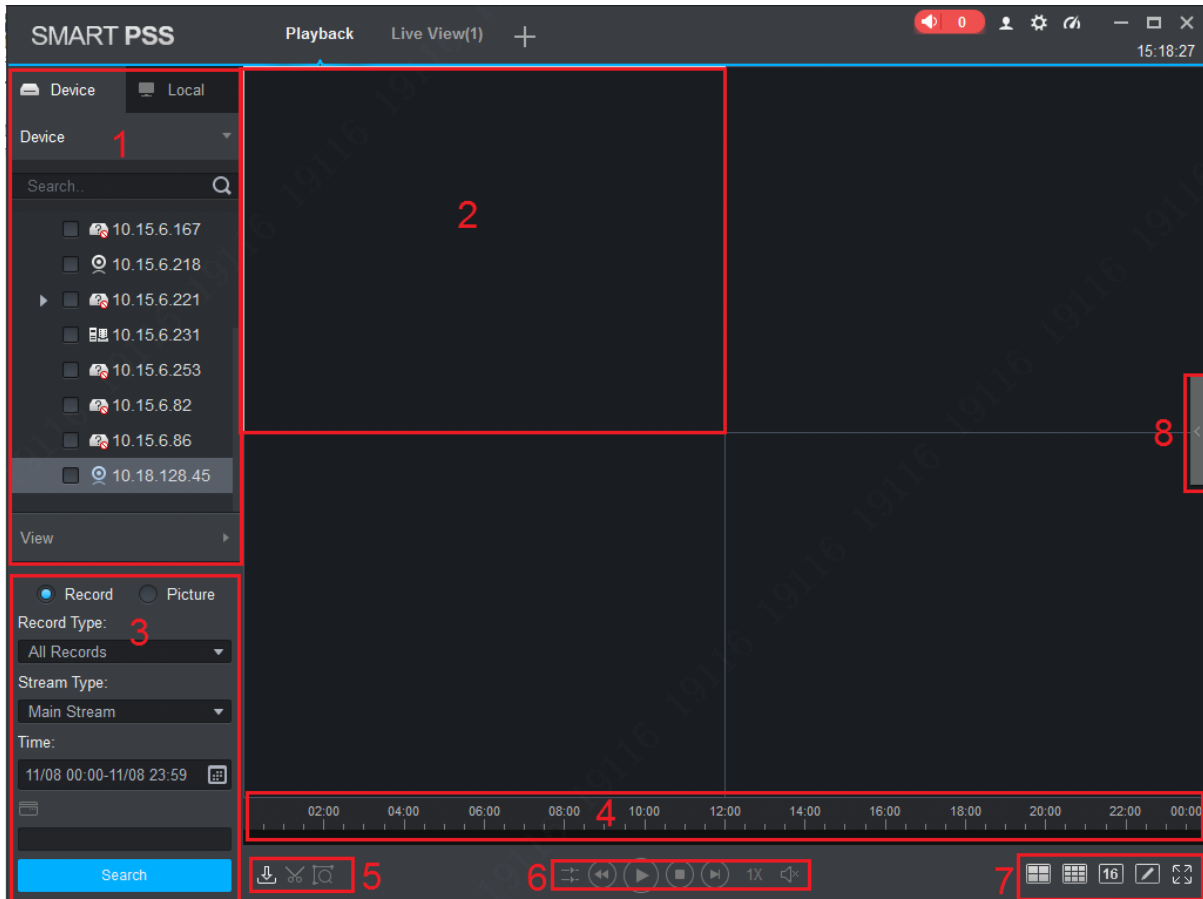









Figure 6-1

No.	Task	Note
1	Playback video	You can play back the recording device. For details, see 6.2 Playback Device Record
	Playback image	You can picture playback device. For details, see 6.4 Playback Device Picture
	Playback local video	You can play back the local video. For details, see For details, See 6.6 Playback Local Record
	Playback local picture	You can play back the local picture. For details, see For details, See 6.8 Playback Local Picture
	Organization Tree / Area Tree	<ul style="list-style-type: none"> When the Default Device Tree is set to Device Tree (by device), the device tree displays the grouping and channels for the device. When a default device tree is set to Area Tree (by

		channel), the device tree display channel. Default Device Tree setting, see 8 System Config
	Logout and login	When the Default Device Tree is set to Device Tree (by device), right-click the device and select Logout. The software and device are disconnected. After logging out, right-click the device, select Login, reconnect device.
	View	In the Device tab, click  behind View. Open View interface, playback view video device.
2	View playback stream information	Choose video window with open video, in status bar it displays the playback stream information.
	Snapshot	Select open video window, click  or right-click to select Snapshot, Snapshot a single picture. You can click  in the homepage; modify the path to save the picture.
	Zoom	Select open playback video window, click  .
	Close window	Select Open playback video window, click  or right click to select Close Window.
	Close all windows	Select the video window, right-click to select Close all windows.
	Set video image ratio	Select the video window, right-select Window Scale, select the video display ratio.
	Enable audio	You can enable audio by following two methods: <ul style="list-style-type: none"> ● Select open playback video window, right-select Audio. ● Playback control toolbar at the click  or , and adjust the volume.
	IVS Overlay	Overlay IVS info, include rule and object box.
3	Set the device record search criteria	In the Devices tab, select the device or view, select Record, set the record type, stream, start time and end time, click Search, the recording information is displayed in the schedule box. <ul style="list-style-type: none"> ● Record type includes all types of video record, general record, alarm record, motion detection record, intelligent record and card record. ● Stream includes main stream and sub stream. ● Interval of start time and end time must be within a day.
	Set the device picture search criteria	In the Devices tab, select the device, or view, select Picture, set the start time and end time, click Search, image information is displayed in the playback window. Interval of start time and end time must be within a day.
4	Time progress bar	Show existing video display information.















5	View progress bar	Click  to view the video or image export progress and export results.
	Export record	Export device video files, see 6.3 Exporting Device Record
	Export picture	Export device picture files, see 6.5 Export Device Picture
	Export local record	Export local video files. See 6.7 Export Local Record
	Open Video	For details, see 6.6 Playback Local Record
	Smart search	Select open playback video window, click  , in the video playback window, select the smart search, click device  again. The software will search for the video motion detection, click  to exit the smart search.
6	Playback control toolbar	<p>Control video playback and audio.</p> <ul style="list-style-type: none"> ●  Video playback from the same point in time for all channels. ●  Reverse video playback. ●  Start video playback. ●  Pause video playback. ●  Stop video playback. ●  Single frame backward playback. ●  Single-frame forward playback. ●  Adjust the playback speed.
7	Set the video window display mode	<ul style="list-style-type: none"> ● In  select the desired video window display mode or select  to customize video window display mode. ● Click  or select the video window, right select full screen, video window full screen display.
8	Video file list	Click the icon to expand the list of the corresponding channel video file, you can select video files for playback and export the corresponding video file.

Chart 6-1

6.2 Playback Device Record

Condition

There is device record inside channel.

Operation steps

Step 1

In playback interface, click Device tab.

Step 2

In Organization Tree, select device channel or select view in View.

Step 3

Select record and set record search criteria.

1. Select record type and stream, and set time.
2. Click Search.

Step 4

Select window with record, click .

See Figure 6-2.

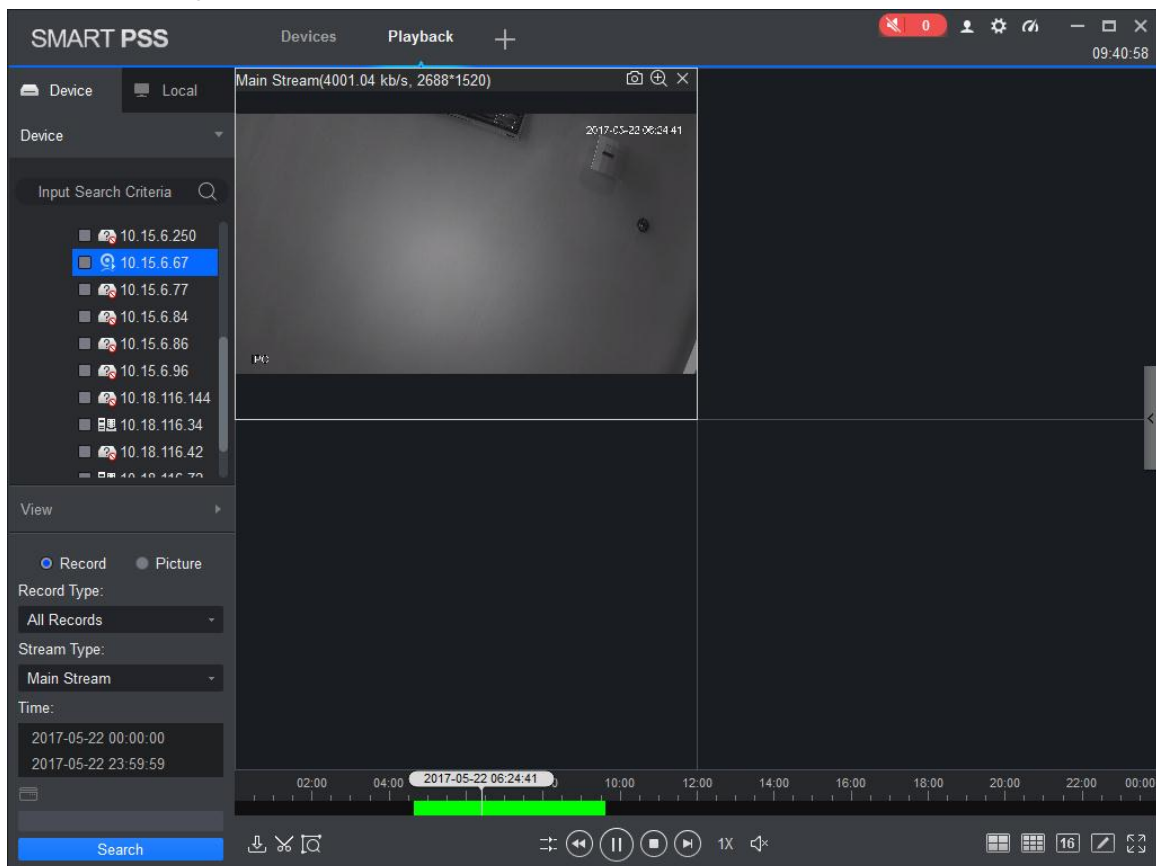

Figure 6-2

6.3 Exporting Device Record

Condition

There is device record inside channel.

Operation Steps

Step 1

In playback interface, click Device tab.

Step 2

In Organization Tree, select device channel or select view in View.

Step 3



Set record search criteria.

1. Select record type and stream, and set time.
2. Click Search.

Step 4

Select window with record, click .

Step 5

Click , system select one record, and adjust record part according to actual need, click  again to export record. See Figure 6-3.

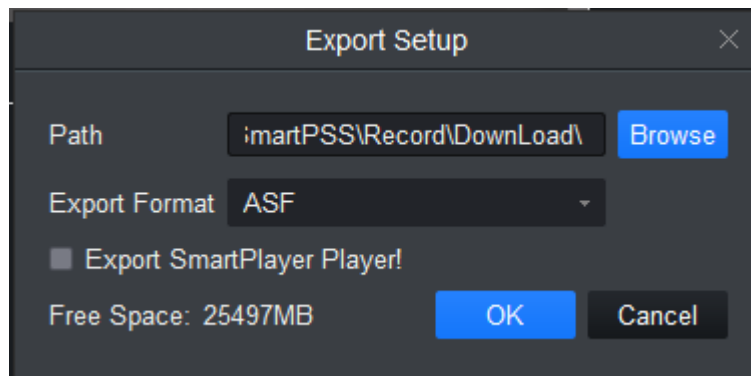

Figure 6-3

Step 6

Select export path and format.



When the Export Format is set to Original Format, please also check the Export Smart Player, export original format player.

Step 7

Click OK.

Step 8

The system displays the playback stop information, click OK.

The system displays the Export Progress dialog box, as Figure 6-4 below.

After recording the download is complete, the system prompts the download is complete.

Click Exporting tab, you can view the video download progress, pause the video being exported to continue downloading the paused video, download again the video failed and delete exporting video; click exported tab, you can view download history and

open video storage path.

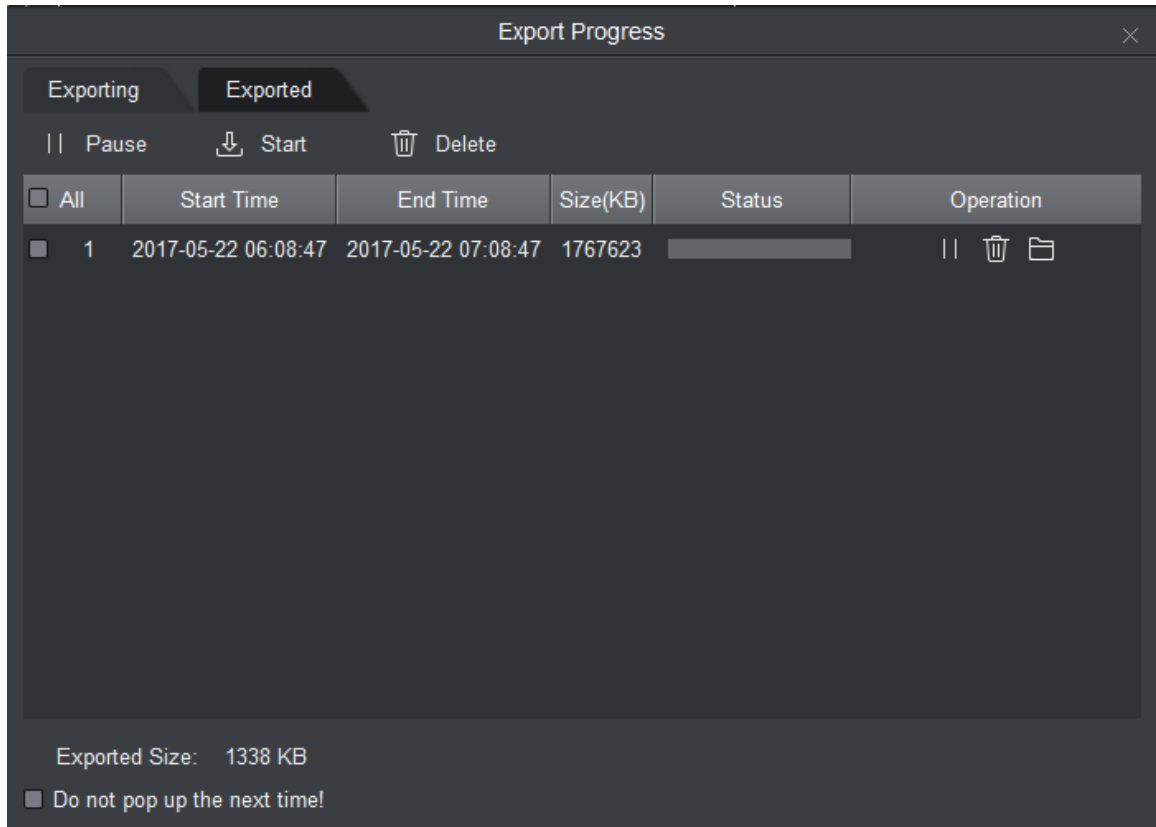

Figure 6-4

6.4 Playback Device Picture

Condition

There is device picture inside channel.

Operation Steps

Step 1

In Playback interface, select Device tab.

Step 2

In Organization Tree, select device channel or in View select view.

Step 3

Select picture and set time. See Figure 6-5.

Click on the right, you can open and close device picture list.

In device picture list, click , device picture list will be shown in format of list; click , device picture list is shown in format of thumbnail.

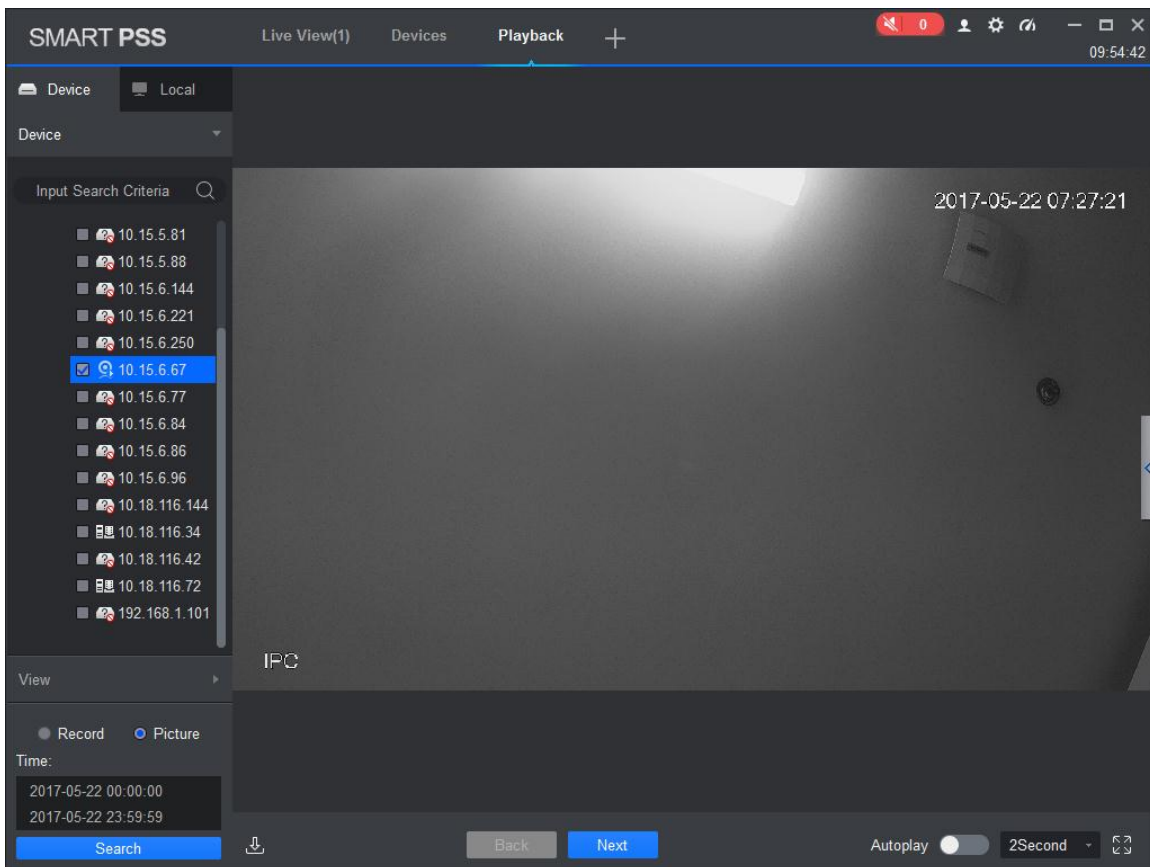



Figure 6-5

Step 4

Playback picture.

- Manual playback: Click **Next** or **Preview**.
- Auto playback: Set auto play interval, click  to auto play (it switch to ) , system will auto playback local picture.

6.5 Export Device Picture

Step 1

In Playback interface, select Device tab.

Step 2

In Organization Tree select device channel or in View select view.

Step 3

Select Picture and set time.

Step 4

Click  on the right, to export device picture.

Step 5

Click . See Figure 6-6.

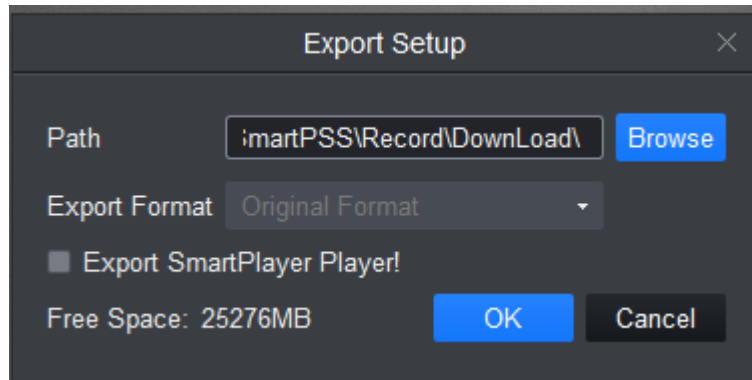

Figure 6-6

Step 6

Select export path, click OK. See Figure 6-7.

Click Exported tab, you can view download record, open picture storage path and delete downloaded file.

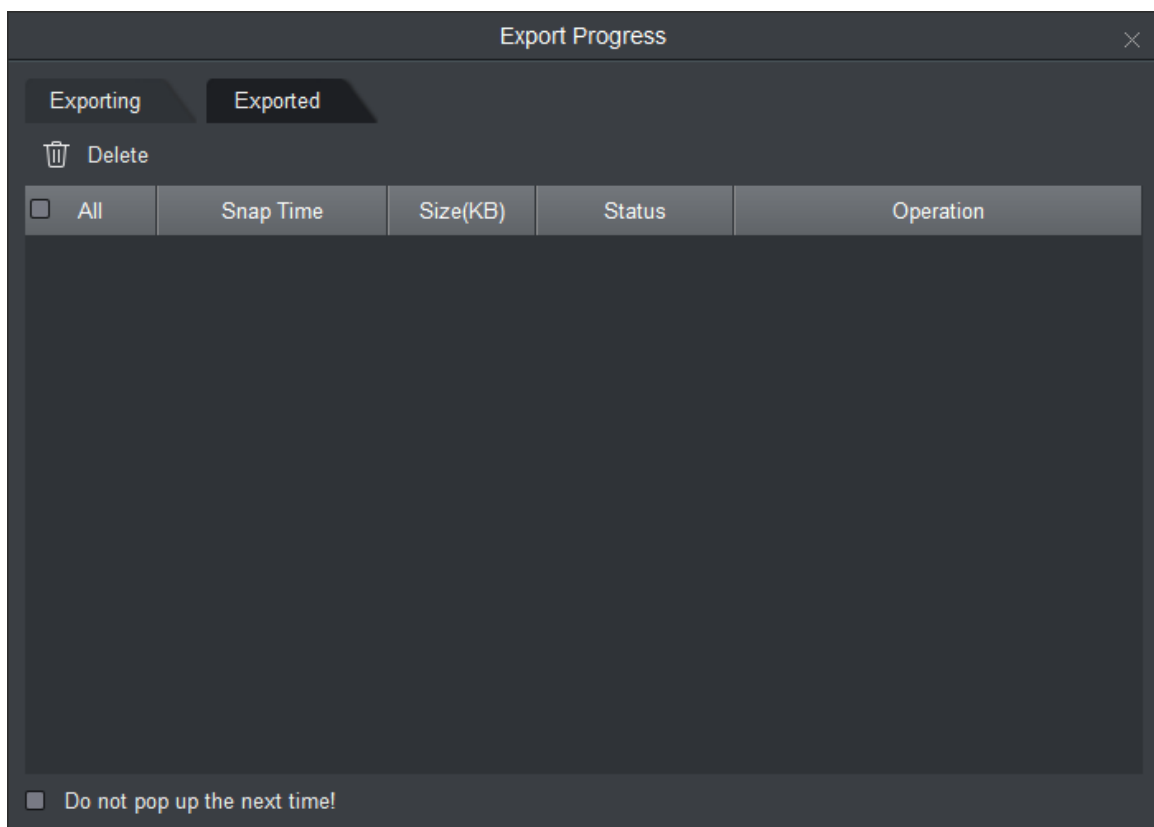

Figure 6-7

6.6 Playback Local Record

Condition

There is local record in the channel, see 4.2 Live View

Operation Steps



Step 1

In Playback interface, select Local tab.

Step 2

Click Record tab.

System shows local record list.

In local record list, click , display in list mode. Click , display in thumbnail mode.

Step 3

Select record to playback, click  or double click record.

See Figure 6-8.



You can click  to open local record file for playback.

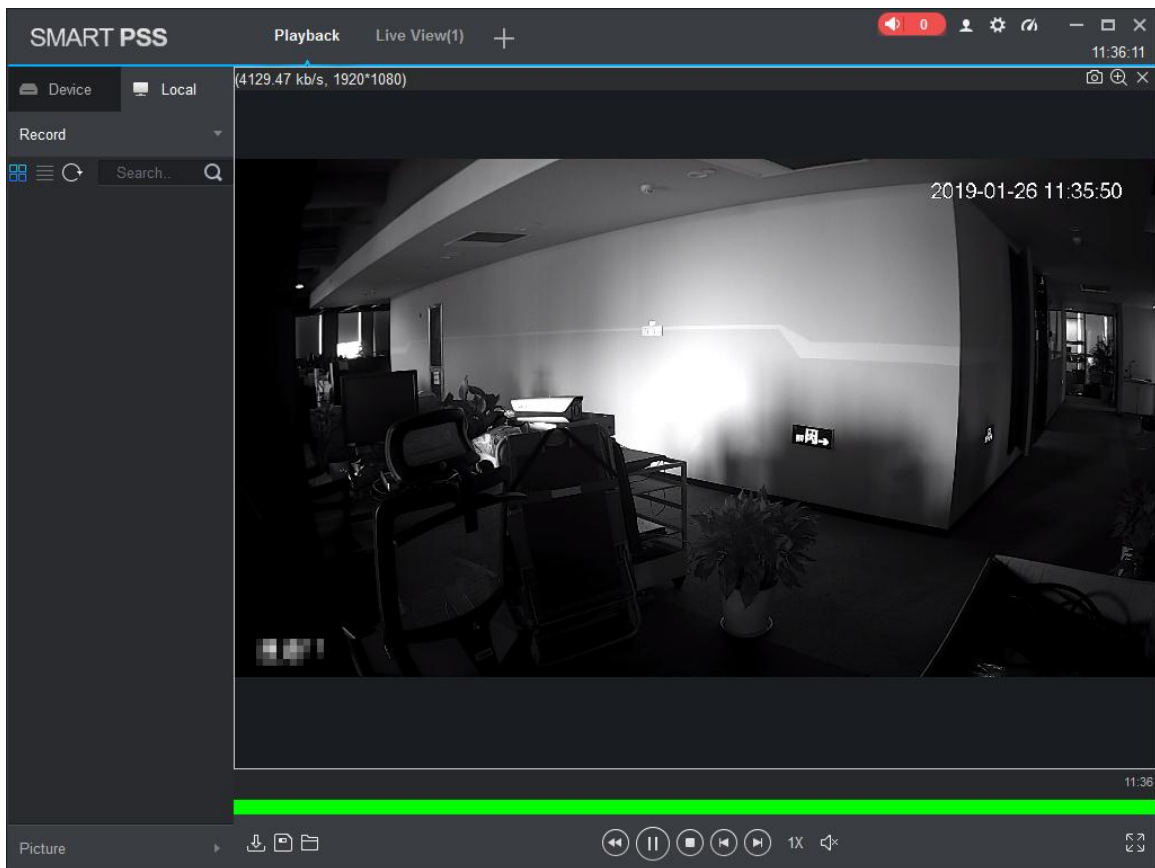

Figure 6-8

6.7 Export Local Record

You can export local record.

Condition

There is local record in this channel, see 4.2 Live View

Operation Steps

Step 1

In Playback interface, click Local tab.

Step 2

Click Record tab.

Step 3

Check record to export, click . See Figure 6-9.

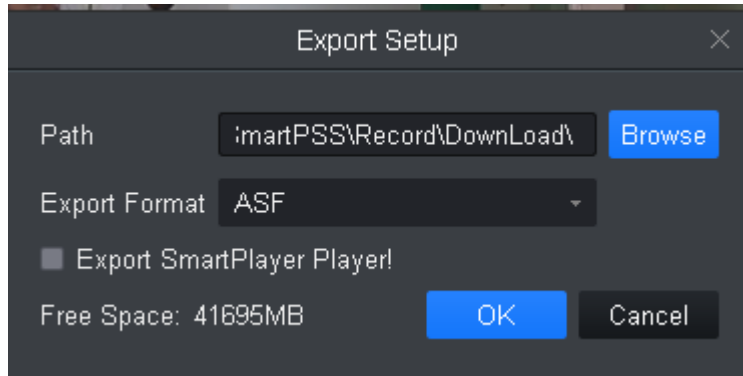

Figure 6-9

Step 4

Select export path and format.



When Export Format is set to Original Format, please check Export Smart Player to export.

Step 5

Click OK.

The system displays the Export Progress dialog box, as Figure 6-10 shown.

After record download is complete, the system prompts the download is complete.

Click Exporting tab, you can view the video download progress, pause the video being exported, resume download paused, and delete videos which being exported; click Exported tab, you can view the download history, open video storage path and delete the downloaded file.

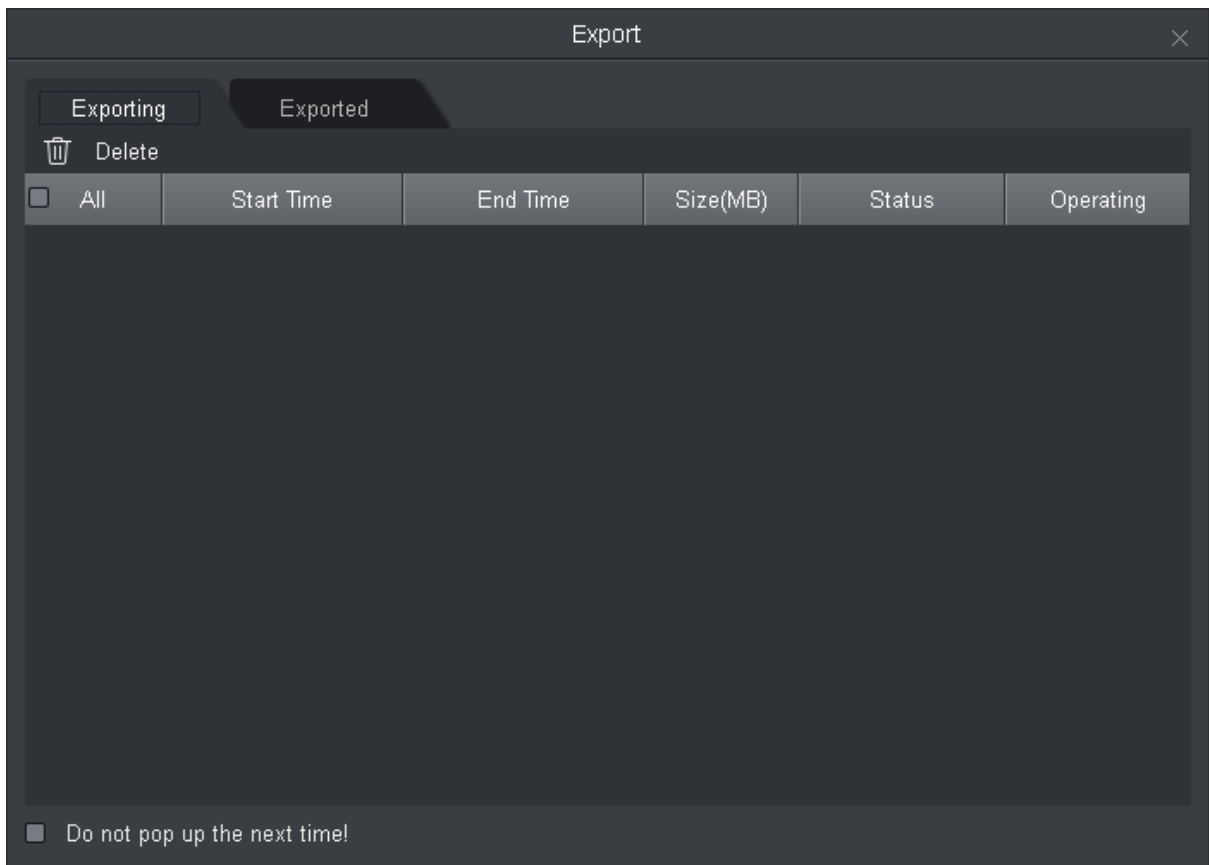

Figure 6-10

6.8 Playback Local Picture

Condition

There is local picture in the channel, see **4.2 Live View**

Operation Steps



Step 1

In Playback interface, select Local tab.

Step 2

Click **Picture** tab.

System shows local record list.

In local picture list, click , display in list mode. Click , display in thumbnail mode.

Step 3

Select picture to playback, click  or double click picture

See Figure 6-11.

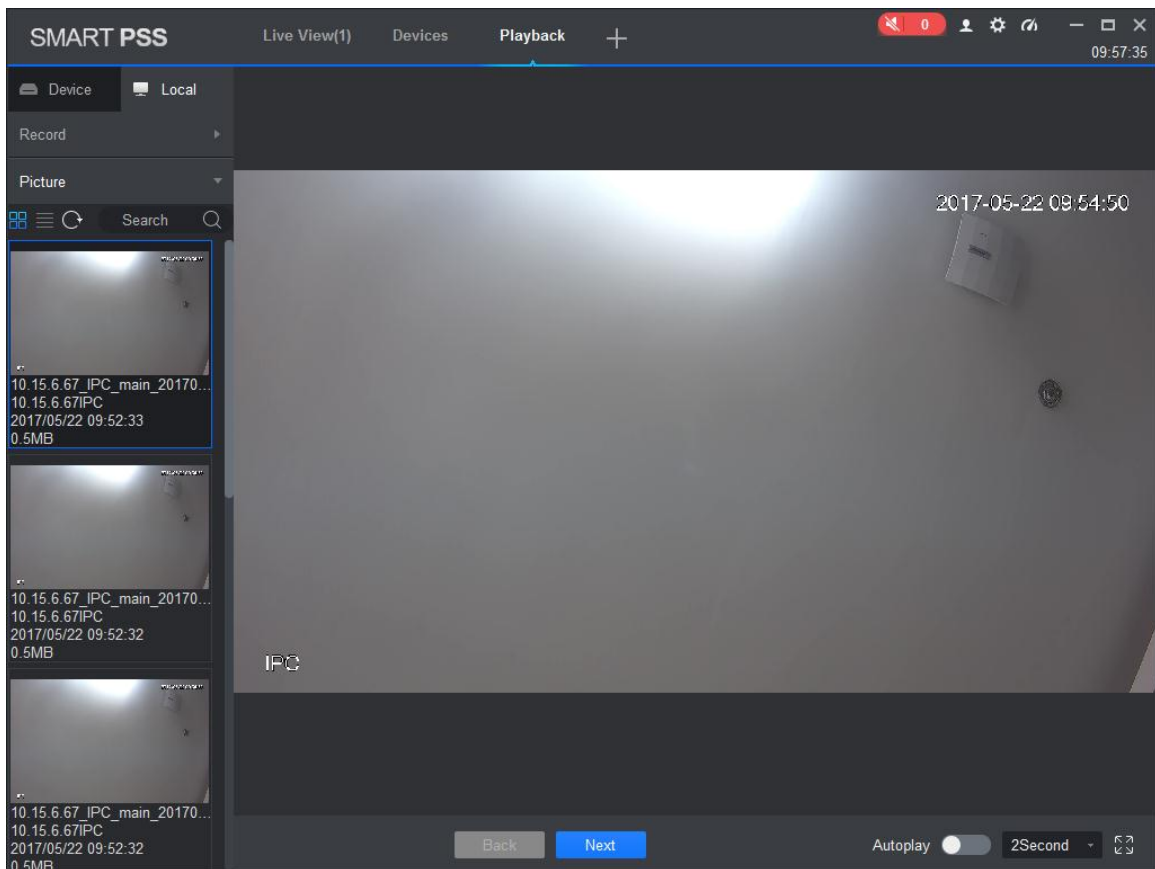

Figure 6-11

Step 4

Playback picture.

Manual playback: Click **Next** or **Preview**.

Auto playback: Set auto play interval, click to auto play (it switch to) , system will auto playback local picture.

7. Log Search

7.1 Searching Client Log

Step 1

In New tab, click Log.

Step 2

Select . System shows Client interface.

Step 3

Set time, type, and keyword. Client log includes system log, operation log and alarm log.

Step 4

Click Search. See Figure 7-1.



After log is successfully searched, you can click Export to export log.

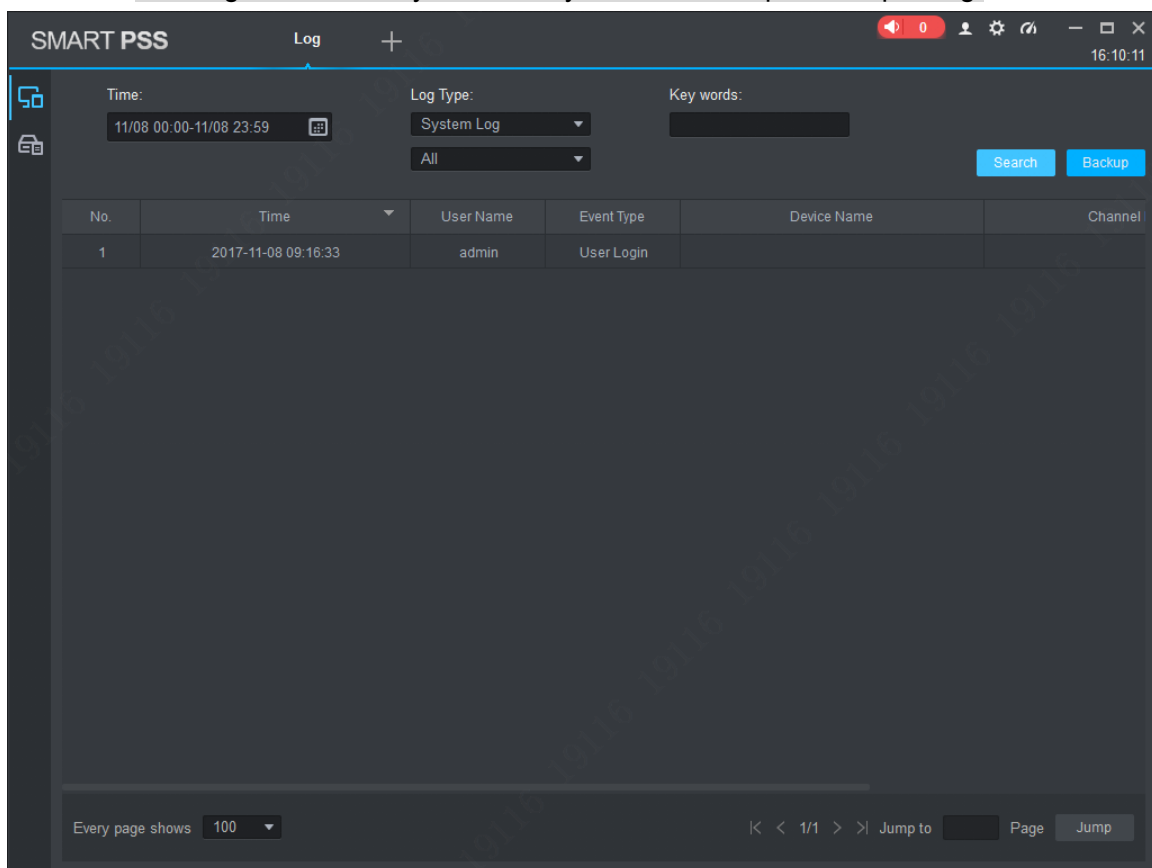

Figure 7-1

7.2 Searching Device Log

Step 1

In New tab, click Log.

Step 2

Select .

Step 3

Set time, type, and device. Client log includes system log, config log, storage log and etc.

Step 4

Click Search. See Figure 7-2.



After log is successfully searched, you can click Export to export log.

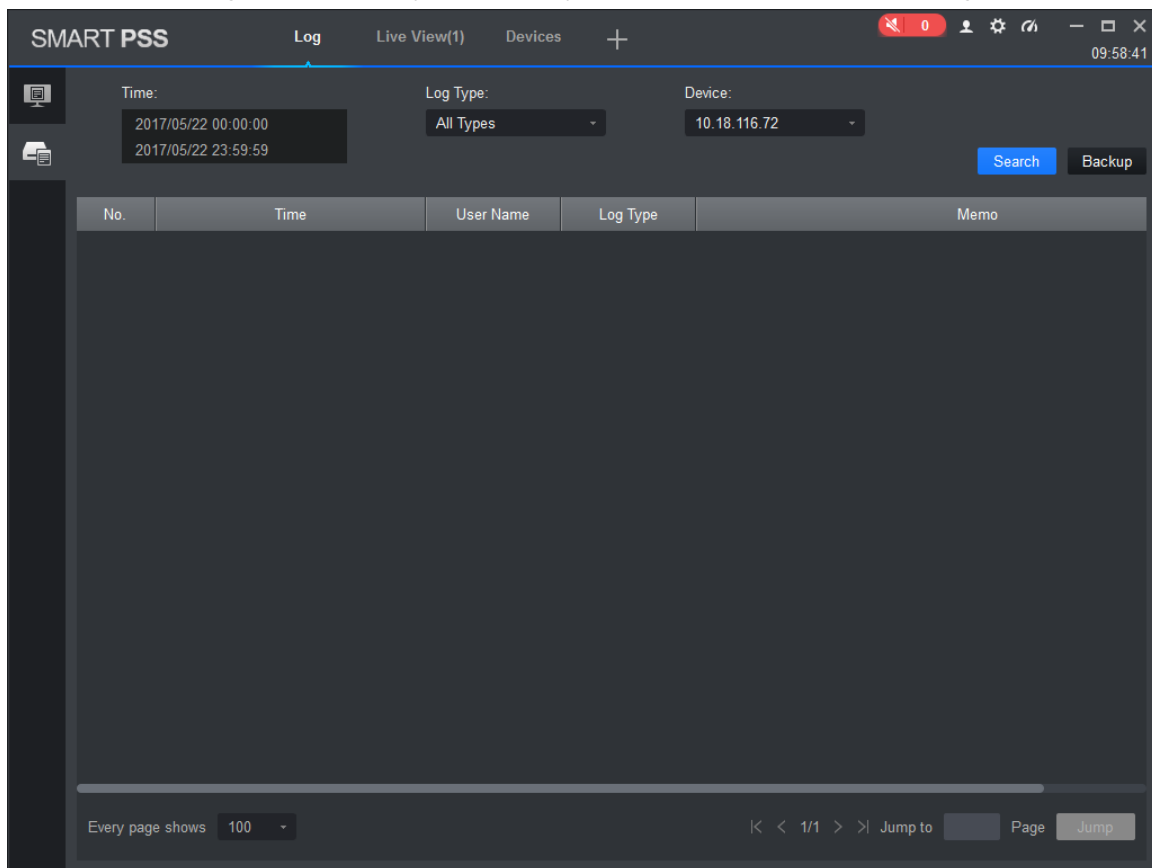

Figure 7-2

8. System Config

You can set up base info, preview and playback, event, log, system and language, hot keys, and local path, backup/restore.

Step 1

In homepage, click . See Figure 8-1.

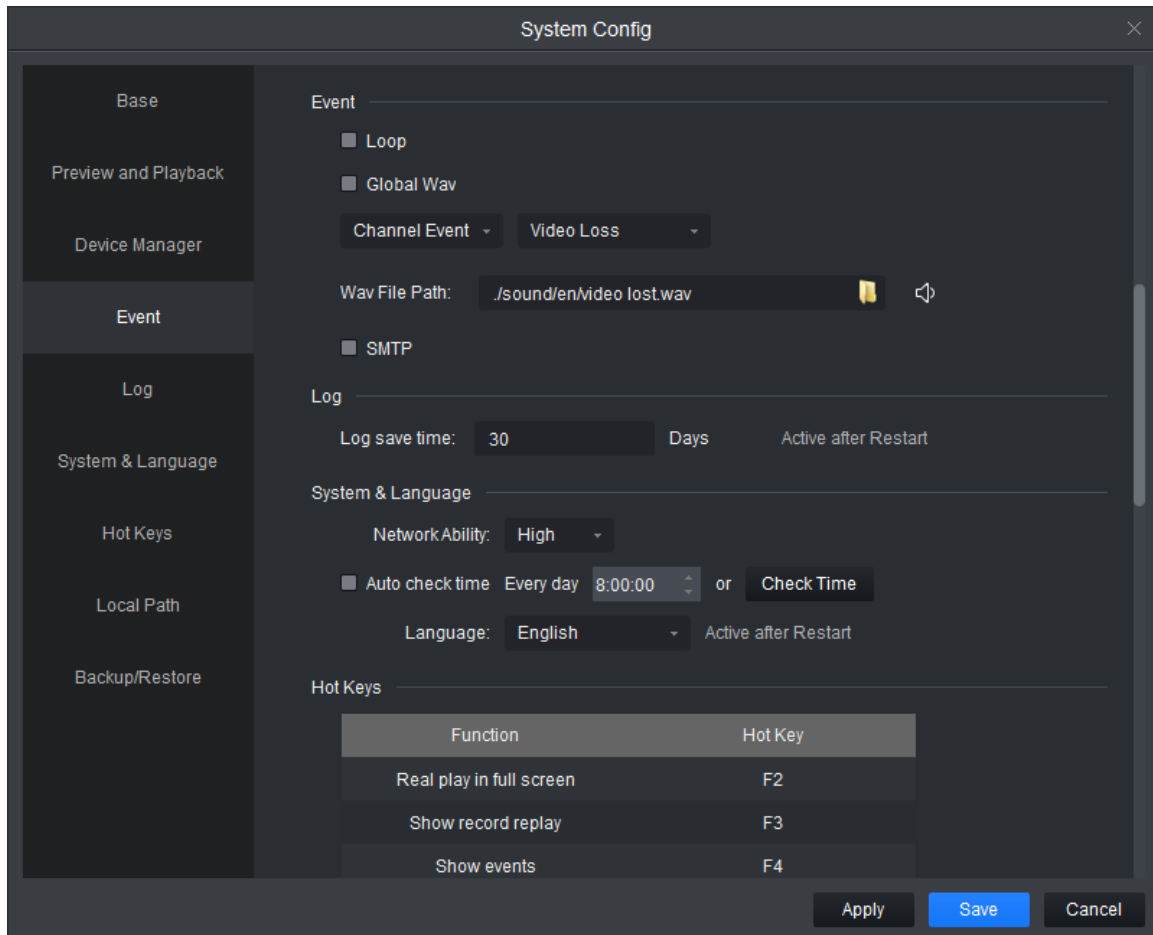





Figure 8-1

Step 2

Set parameters, see Chart 8-1

Parameter Type	Parameter	Note
Base	Initial page	Select page shown when you open the software, including new feature page preview interface and will recovery not closed tabs
	Maximum behavior	Maximize display software, including full screen and maximized window.
	Minimum behavior	Check show floating window, display floating window when the software is minimized.
	Default video	Set the preview or playback video default ratio, including

	scale	the original scale and full screen.
	Default device tree	Set the preview, playback and other interface devices tree display formats. Modify this parameter to take effect after the restart the software needed. Include following options: <ul style="list-style-type: none"> ● Device tree (according to device): grouping by device ● Area tree (according to channel): grouping by channel
	Audio NE Level	Set audio NE level within 1~5.
Preview and Playback	Default Stream Type	Set stream type of preview, including mains stream, sub stream, and self-adaptive stream.
	Instantly Replay Time	Set at time instant replay of the preview screen.
	Resume last preview	Check the Resume last preview software record video window status when closing software, and after re-login open the preview screen, the video will be restored as before the software is closed.
	Show IVS Rule	Show IVS rule in preview and playback video.
	Save Device Tree Selection	Select Save Device Tree Selection, after record search end, device will keep selected status.
Face recognition		Set properties of face snapshot, including age, gender, expression, glasses, mouth mask and beard. <ul style="list-style-type: none"> ● Select property item, and display recognition info, such as  as . ● Not select property item, and then it will not display corresponding info, such as .
Device	Show device channel number	Check the Show device channel number, then in Device interface software automatically assigns a unique no. to device, you can modify this no. This no.of device is used for keyboard.
	Auto login device	Check the Auto login device, restart the software, the software automatically logged added device. Modify this parameter to take effect after the restart the software as needed.
	Auto fill user and key	Check the Auto fill user and key, enter your username and password, the software automatically login added device according to the username and password.

		If the login username and password set are the same as user and password of the device, then login is successful, otherwise the login fails.
Event	Loop	Check the Loop, looping alarm when an event occurs.
	Global wav	<ul style="list-style-type: none"> ● Check the Global wav, select audio file path, then all alarms shall play the audio file. ● Not check the Global wav, select different types of events and events in the drop-down list, and separately set their corresponding audio file.
	SMTP	Enable SMTP (email) and set email info, when an event occurs, it will send an email.
Log	Log saved time	Setting the log storage time, modification to this parameter will be effective only after this software is restarted.
System and Language	Network ability	Set the network according to actual network performance.
	Auto check time	Check the Auto check time, and set the corresponding point in time, when the software is open during sync time, and device added on client automatically synchronize with your local PC time.
	Check time	Click Check time, device added on client immediately synchronization time.
	Language	Set the language of the software, modify this parameter to take effect after the restart the software as needed.
Hotkeys		<p>Set shortcut keys for common operations systems. Double click the hotkey column in the corresponding function of the hotkey, then set the hotkey function on the keyboard, click the Apply, modify the corresponding hotkey function.</p> <p>Click Reset to restore default software.</p> <p>Common operations include preview full-screen, open playback module, open event module, open system configuration, open tour plan configuration, enable/disable tour plan, snapshot, lock, switch users, open / close linkage video, turn on / off video .</p>
Local Path	Pic path	Set picture path.
	Record path	Set record path.

	Face recognition picture path	Set storage path of face snapshot and face comparison. <ul style="list-style-type: none"> ● Face snapshot: 2 snapshots a time, 1 face snapshot and 1 panoramic picture. ● Face comparison results: Comparison succeeded and 2 pictures are saved, 1 uploaded to face database and 1 face snapshot.
	Human body feature path	Set storage path of human body feature snapshot.
Backup/Restore	Backup	Click Backup to back up config file,
	Restore	Click Restore, and select exported config file to restore config.

Chart 8-1

Step 3

Click Save.

9. User

9.1 Role Info

You can add, modify and delete role.

Step 1

In New tab, click User, see Figure 9-1.

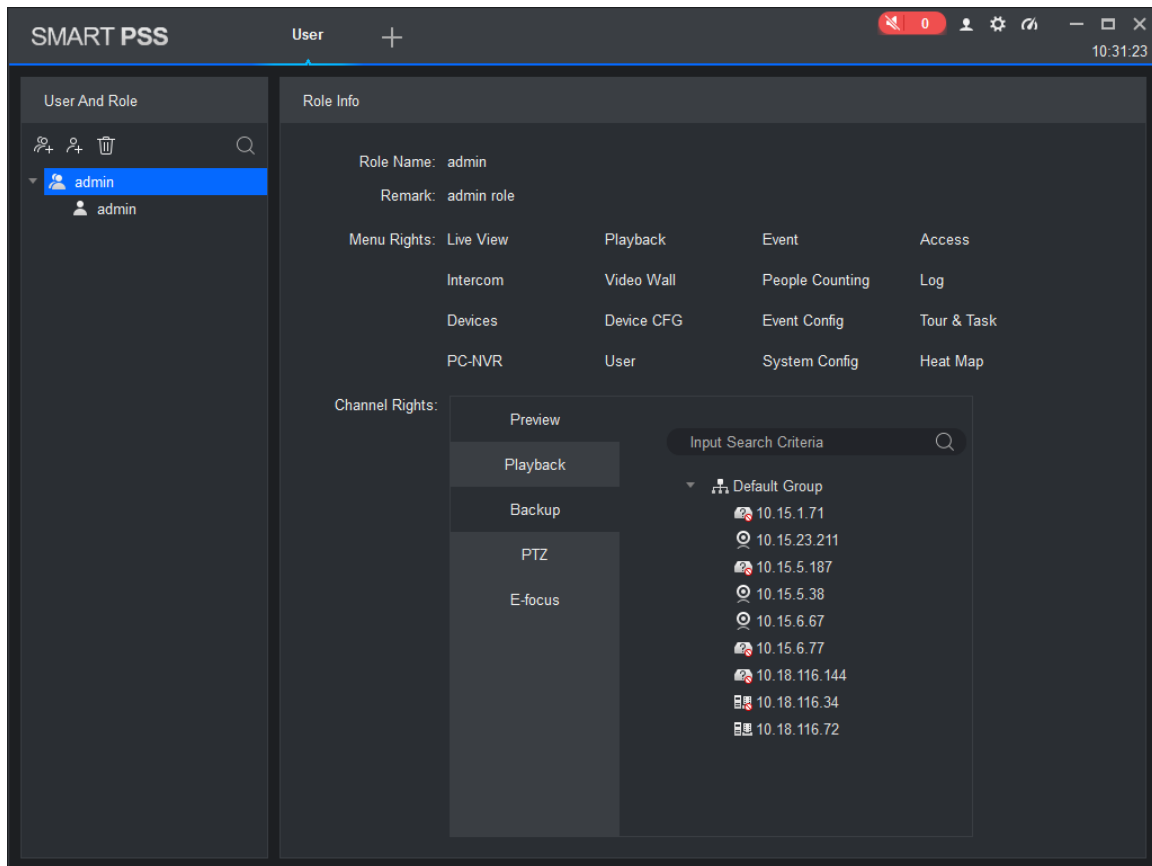



Figure 9-1

Step 2

Click . See Figure 9-2.

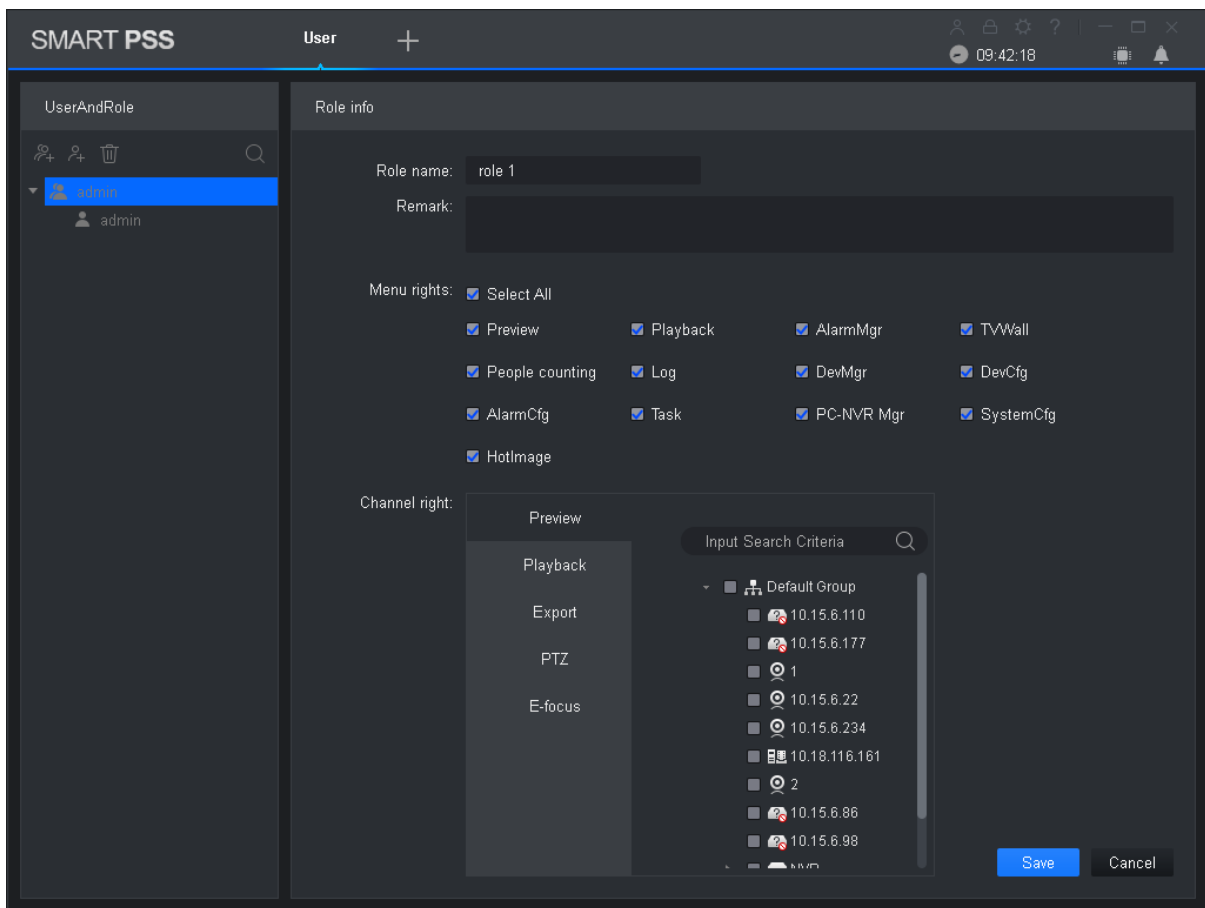

Figure 9-2

Step 3

Set role name and fill in remark.

Step 4

Check menu right of the role, and select tab and set role channel right in Channel right area.



When user of the corresponding role logs client, and in New tab it does not show non-allocated menu right, and in corresponding device tree it does not show non-allocated channel right.

Step 5

Click Save.



Admin has all rights which cannot be modified or deleted. After a role is added, you can modify its right or delete it.



When you delete a role, users of this role will also be deleted.

9.2 User

You can add, modify and delete user.

Step 1

In New tab, click User. See Figure 9-3.

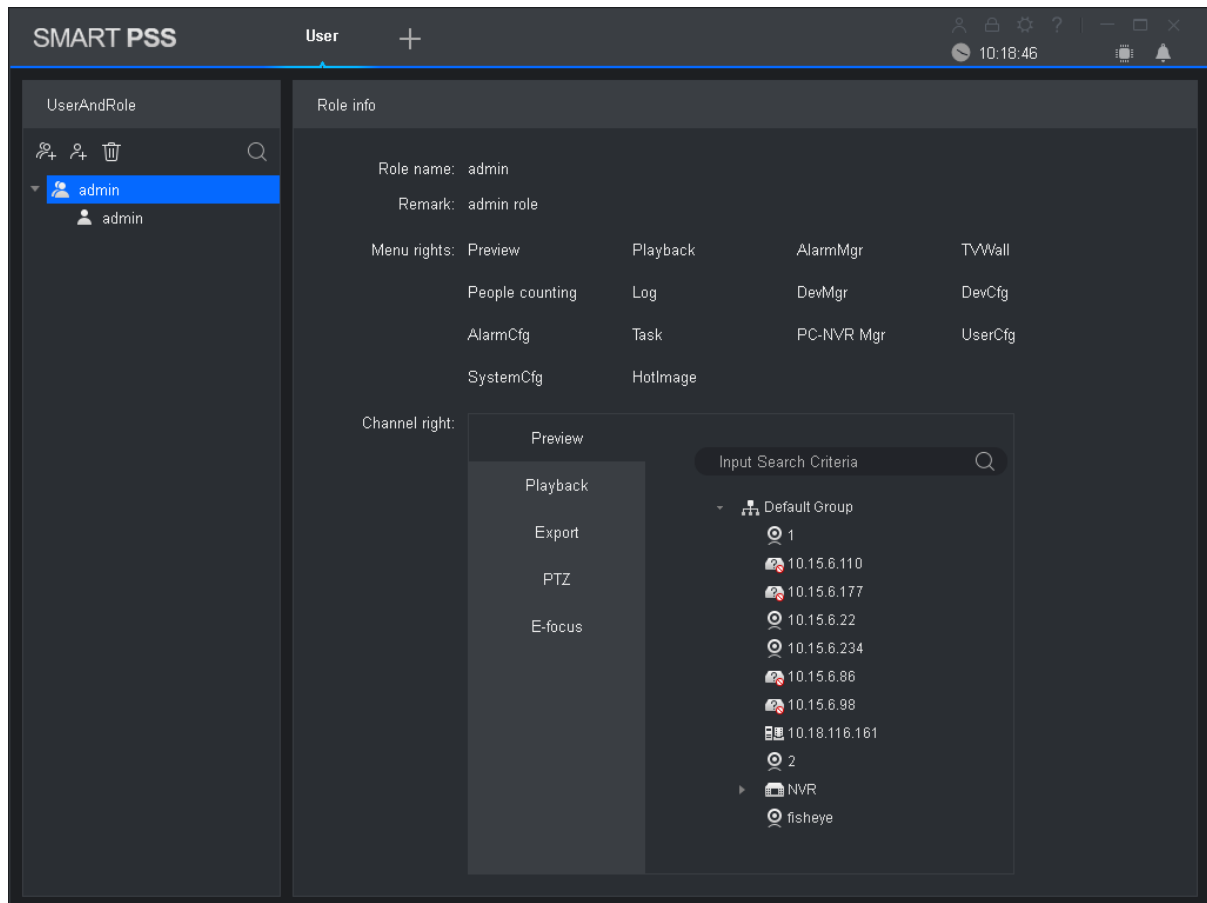

Figure 9-3

Step 2

Select role which you want to add user. See Figure 9-4.

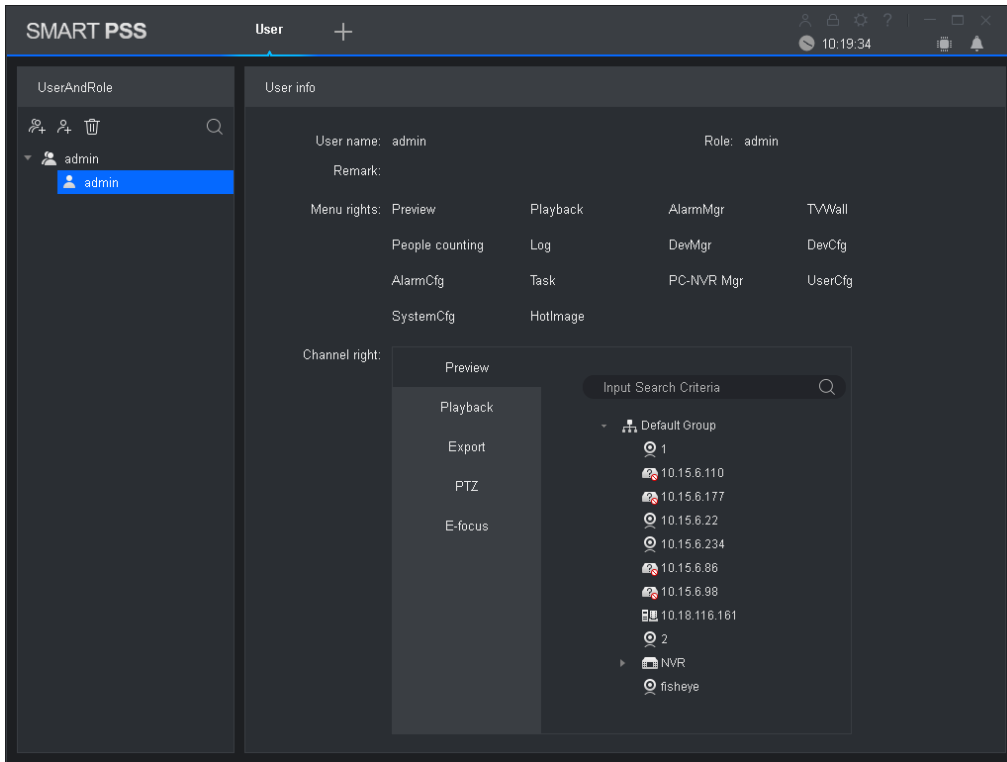

Figure 9-4

Step 3

Set user parameter, see the following chart.

Parameter	Note
Username	Username which cannot repeat existing username.
Role	Select a role the user belongs. Different user permissions are for different roles.
Password	The user's password and confirm the password.
Confirm	
Remark	Description of the user information.
Menu rights	According to the actual need select the user's menu rights
Channel rights	According to the actual need select the user's channel rights

Chart 9-1

Step 4

Click Save.



Admin has all rights which cannot be modified or deleted. After a role is added, you can modify its right or delete it.

10. Device Config

You can update software, connect to WEB, configure device camera, network, PTZ, event, storage, system and etc.

In New tab, click Device CFG, see Figure 10-1. Different devices may have different parameters, subject to actual device and manual.

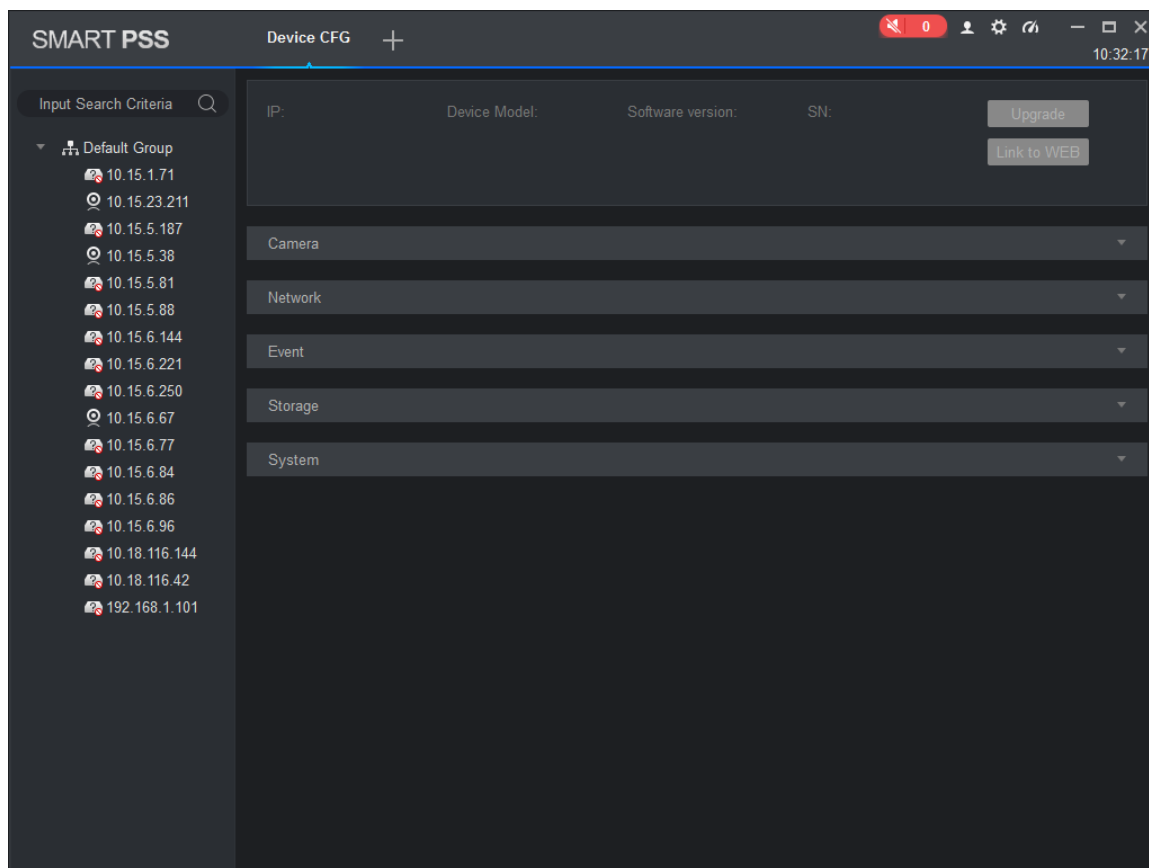

Figure 10-1

No.	Task	Note
1	Device	Select device, you can view the device's IP address, device model, software version and serial number.
	Upgrade	Select device, click the Upgrade, you can upgrade the device program.
	Link to WEB	Select the device, click the Link to WEB, can be linked to WEB config interface.
2	Camera	Select device, open the Camera . <ul style="list-style-type: none"> ● Click Remote Device, you can search device and add the device or remove device. ● Click the Camera, you can configure the camera attributes, operations, management or head profile. ● Click the Video, you can configure the video code, or snapshot stream video overlay information. ● Click the Audio; you can configure the audio code stream, input type and volume.
	Network	Select the device, open the Network tab. <ul style="list-style-type: none"> ● Click TCP / IP, you can configure a static IP address of

		<p>the device or the device to obtain an IP address via DHCP.</p> <ul style="list-style-type: none"> ● Click Connect, you can configure the maximum number of connected devices and the port number to use when connecting. ● Click PPPOE, you can configure the PPPoE username and password to access the device via PPPoE dialing. ● Click DDNS, you can configure the device and DDNS server domain names, access device through its domain name. ● Click the IP Rights, you can configure a whitelist and blacklist devices. ● Click SMTP (e-mail), you can configure the device's SMTP server and mailbox information when the device is configured alarm linkage and alarm messages, the recipients of the message recipient to send alarm information. ● Click FTP, the device can be configured FTP upload information and pictures, pictures in the manner set upload FTP appropriate directory. ● Click Multicast, you can configure the multicast address and port, through surveillance video multicasts. ● Click Alarm Center, you can configure the alarm center host IP address and timing login time.
	PTZ	<p>Select device, open PTZ tab. Click PTZ, you can configure PTZ and stimulate PTZ.</p>
	Configuring event parameters	<p>Select the device, open Events tab.</p> <ul style="list-style-type: none"> ● Click the Video Detect, you can configure motion detection, video loss detection, video tampering detection and defocus detection. ● Click the Audio Detect, you can configure audio input and sound intensity abnormality. ● Click Intelligent Analysis, can mark video quality diagnosis, general behavioral analysis, face detection, people counting and depth of field heat map. ● Click Alarm I/O, you can configure the alarm inputs and alarm linkage information. ● Click Abnormality, you can configure no space, storage device error, IP conflict and etc.
	Storage	<p>Select device, open Storage.</p> <ul style="list-style-type: none"> ● Click Schedule, you can configure the video snapshot and snapshot plan. ● Click HDD Manager, you can configure and view locally stored information about the device, configure the FTP server. ● Click the Record; you can configure the video stream control method.
	System Parameters	<p>Select the device, open the System tab.</p> <ul style="list-style-type: none"> ● Click General, you can basic information and time. ● Click PTZ, you can configure the analog PTZ information. ● Click Account, you can add, delete users and user groups.

		<ul style="list-style-type: none">● Click Maintenance, you can configure serial information, system configuration and maintenance information plus view version information.
--	--	--

Chart 10-1

11. Event Config

11.1 Event Type

In New tab, click Event Config, see Figure 11-1.



Client shows all event types, different devices support different event types, subject to actual device.

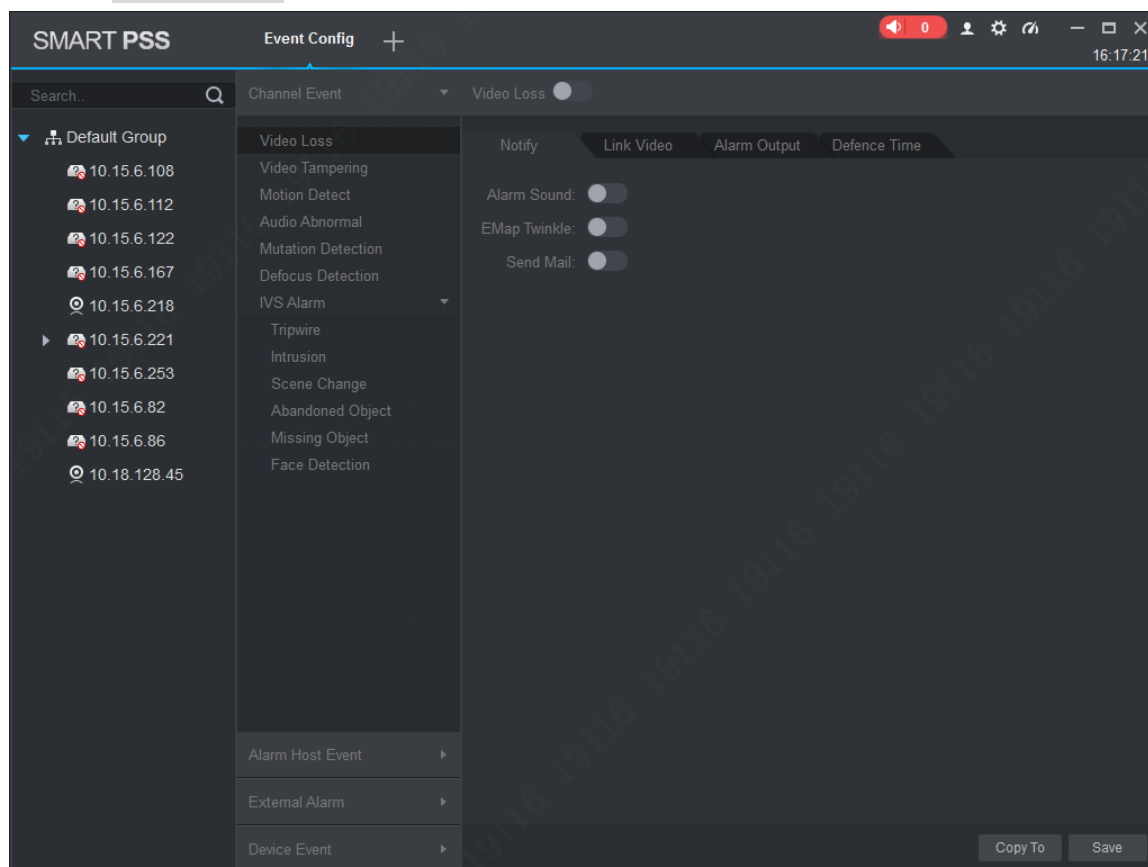

Figure 11-1

The event type	Event	Note	Condition
Channel event	Video loss	Network abnormality causing video loss	Video loss detection is ON.
	Video tampering	Event is generated when video is tampered.	Video tampering is ON.
	Motion detect	Event is generated when it is detected moving object in video.	Motion detect is ON.
	Audio abnormal	Event is generated when the audio	Audio abnormal

		connection is abnormal.	is ON. .
	Audio mutation	Event is generated when the sound suddenly changed.	Audio mutation is ON.
	Defocus detect	Event is generated when defocus occurs.	Defocus detect is ON.
	IPC External Alarm	For only NVR/HCVR. Check external alarm input of IPC connected to NVR/HCVR.	N/A
	IPC Offline Alarm	For only NVR/HCVR. Check event occurs when IPC disconnected to NVR/HCVR.	N/A
IVS Alarm	Tripwire	Event is generated when the target cross line from set direction.	Tripwire is ON.
	Cross warning zone	Event is generated when the object enters or leaves the area, or the target appears in the region.	Cross warning zone is ON.
	Scene switch	Event is generated when the scene changes.	Scene switch is ON.
	Abandoned object detection	Event is generated when the monitor screen have left more than the target time set by the user.	Items turned legacy detection.
	Missing object detection	Event is generated when the monitor screen after the target is removed over a certain time.	Items move detection is turned on.

		Face detection	Event is generated when the monitor screen detects the person's face.	Face detection is ON.
		Loitering detection	Event is generated when the target continuously present in the monitored area longer than the set time.	Loitering detection is ON.
		Crowd gathering estimation	Event is generated when the crowd gathered in monitor area or crowd density is too large.	Crowd gathering estimation is ON.
		Fast moving	Calculate target actual speed and when target moving speed exceeds the set speed, event is triggered.	Fast moving is ON.
		Parking detection	Event is generated when the vehicle in stationary time exceeds a set time.	Parking detection is ON.
External event	Alarm input 1 to input n N are different according to device alarm input structure.		Event is generated when there is external alarm input.	Device has alarm input interface.
Device Event	No disks		Event is generated when the device does not have storage devices.	No disks is ON (SD card or hard disk).
	Disk fault		Event is generated when the device has hard disk failures.	Disk fault is ON.
	Disk full		Event is generated when the device disk is full.	Disk full is ON.
	Illegal access		When the login password you enter are consecutively	Illegal access is ON.

		incorrect, and reach the limit, event is triggered.	
	Device Offline	Event occurs when device is offline.	N/A
	Voltage Alarm	Check IPC voltage, when voltage is higher or lower than preset, trigger alarm.	N/A
Alarm Controller	Power Failure	Trigger alarm when power has failure.	N/A
	Low Battery	Trigger alarm when battery is 0%.	N/A
	PSTN Power Off	Trigger alarm when PSTN is offline.	N/A
	Disk Full	Trigger alarm when disk is full.	N/A
	Bad Disk	Trigger alarm when disk is bad.	N/A
	Emergency Alarm	Trigger alarm when emergency occurs.	N/A
	Extension Module Loss	Trigger alarm when extension module is lost.	N/A
	Arm/Disarm Change	Trigger alarm when arm/disarm changes.	N/A
	Bypass Mode Change	Trigger alarm when bypass mode changes.	N/A
	Vandal-proof Alarm	Trigger alarm when device is removed from installation position.	N/A

Chart 11-1

11.2 Event Alarm Link Config

11.2.1 Link Notice

After set link notice, when event occurs, it will alarm or alarm flash on map.

Step 1

In New tab, click Event CFG.

Step 2

Click device and select event type.

Step 3

Slide  to turn on event, click Notify tab.

Step 4

Click Notify tab. See Figure 11-2.

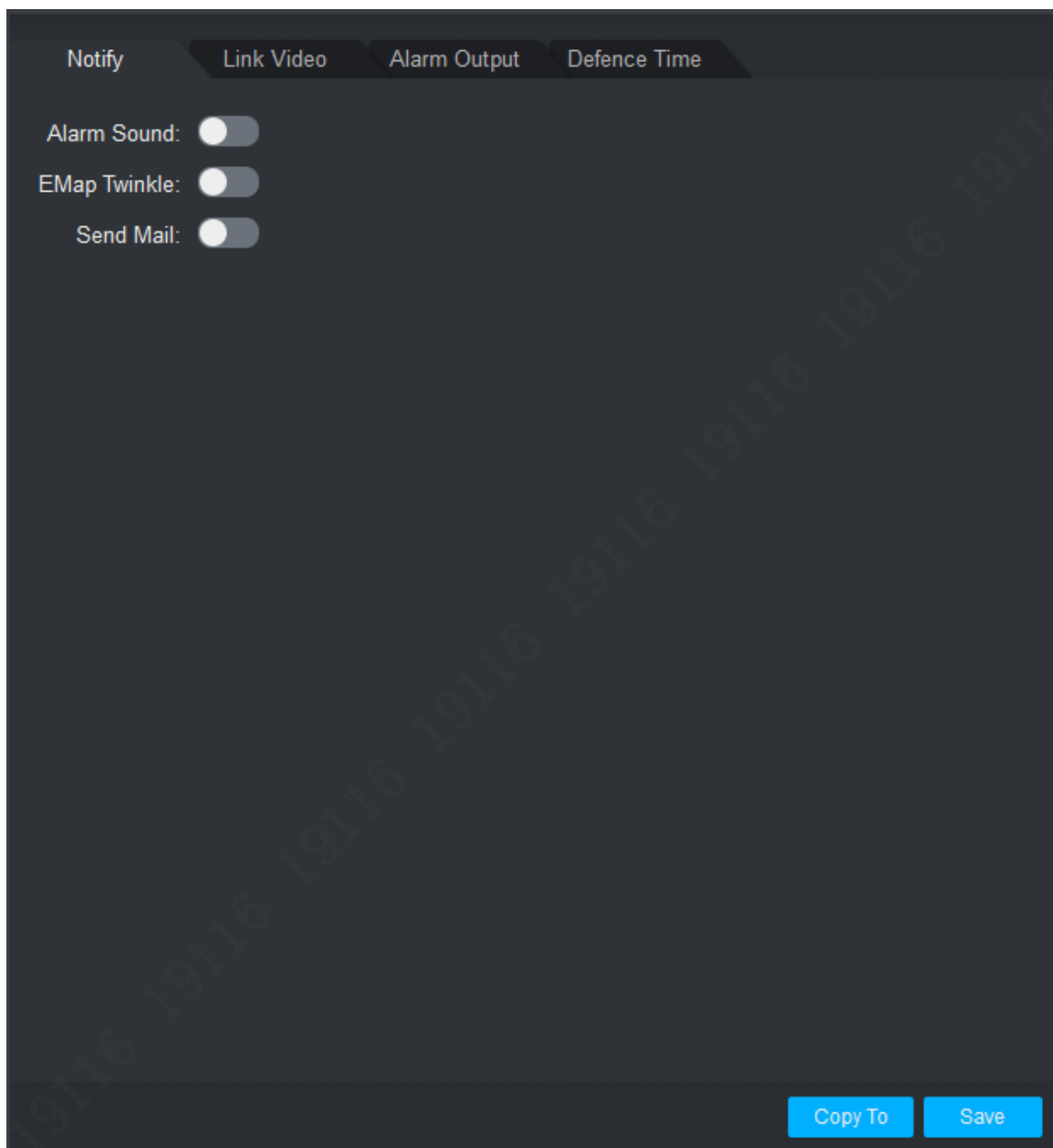



Figure 11-2

Step 5

According to need, slide  to enable alarm sound or map flash.

Step 6

Click Save.

Click Copy to, you can link config of this camera to other device.

11.2.2 Link Video

After you link video, when corresponding event occurs, it will link corresponding camera preview or record.

Step 1

In New tab, click Event CFG.

Step 2

Click device and select event type.

Step 3

Slide  to enable event and click Link Video tab. See Figure 11-3.

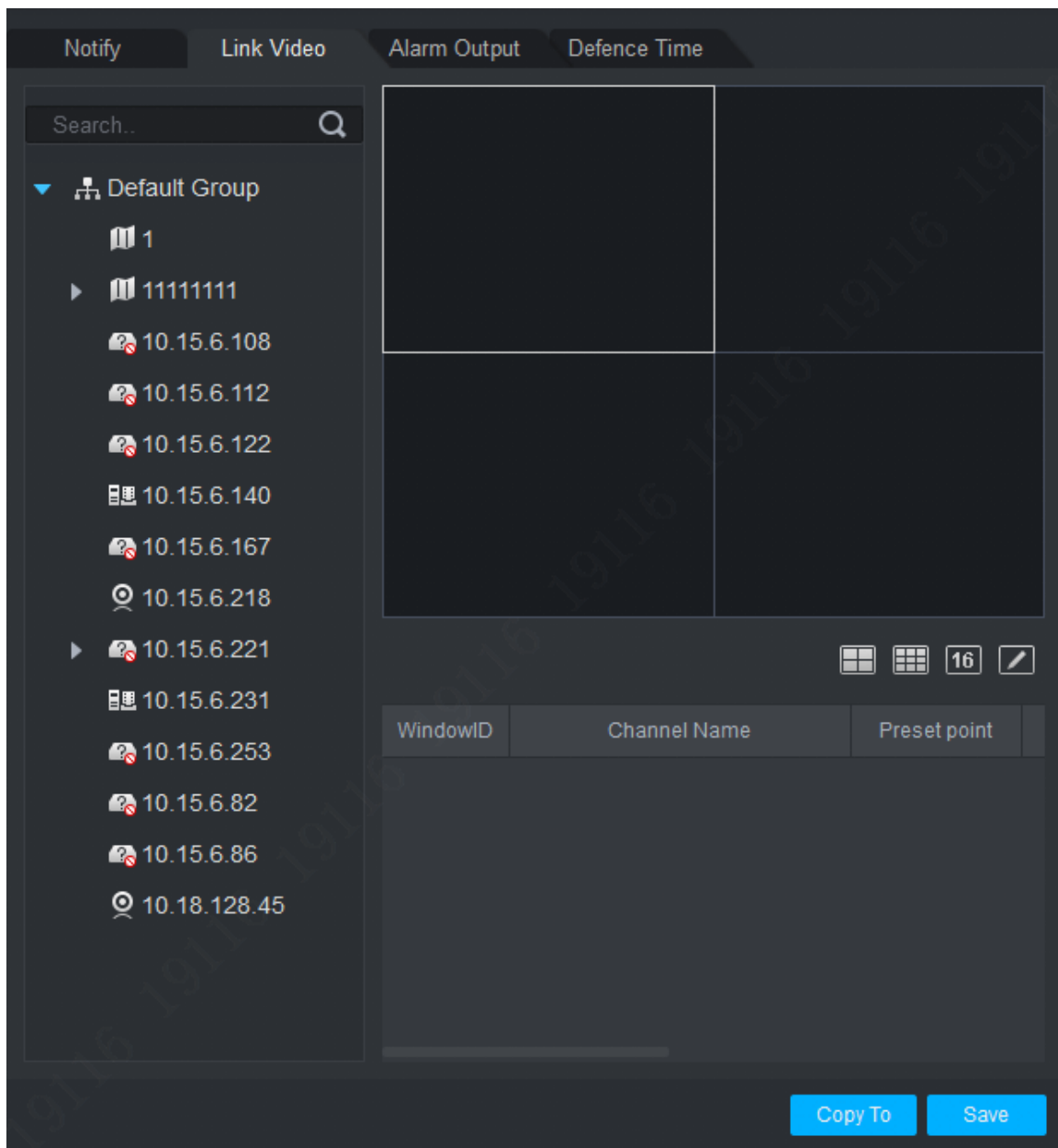



Figure 11-3

Step 4

Select video window, and double click camera you want to link, directly drag it into window.



On , you can set display mode.

Step 5

In camera list to be linked, set camera preset, link record or preview stream type, whether auto open video and enable record when event occurs, linked record or preview duration.



Click , you can delete camera.

Step 6

Click Save.

Click Copy to, you can copy camera link config to other devices.

11.2.3 Link Alarm Output

After you configure link alarm output, when alarm occurs, it will link corresponding camera alarm output.

Step 1

In New tab, click Event CFG.

Step 2

Click device and select event type.

Step 3

Slide  to enable event, and click Alarm Output tab. See Figure 11-4.

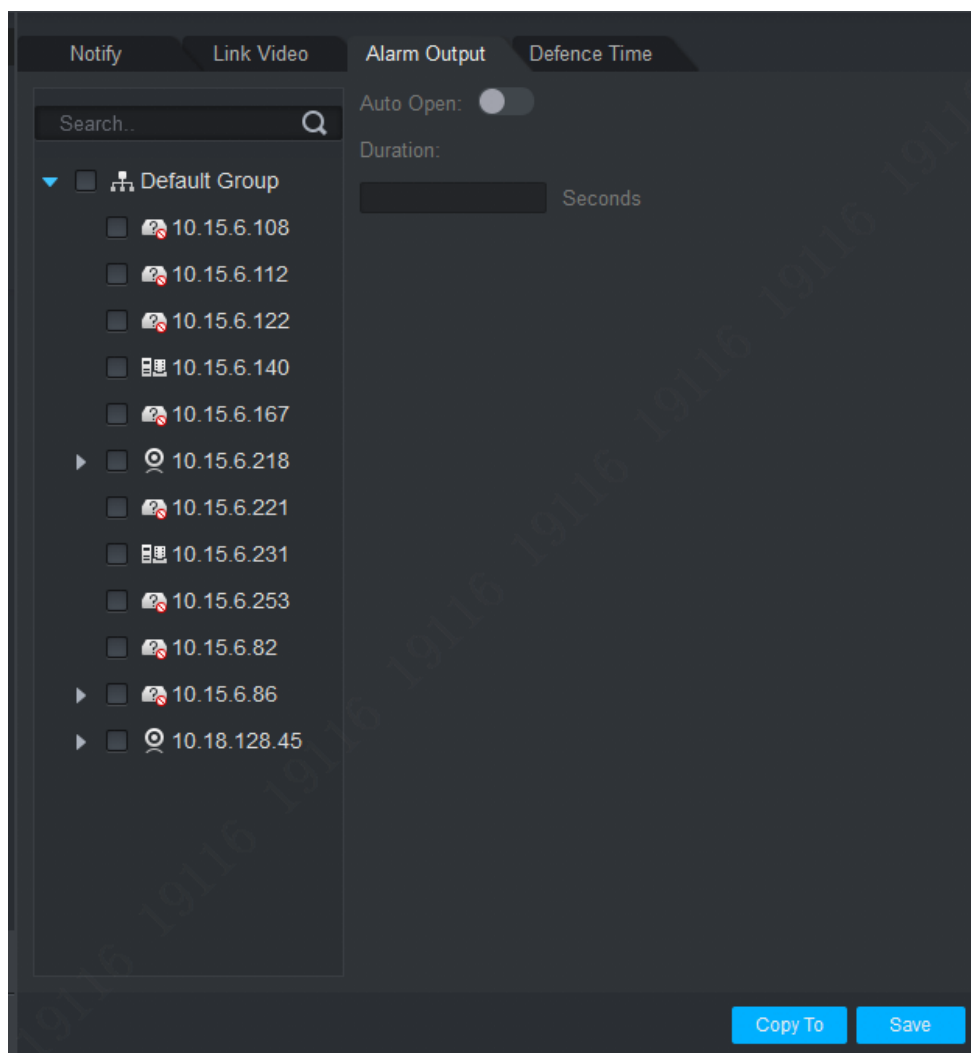

Figure 11-4

Step 4

Select alarm output of link camera and set whether to auto enable and duration.

Step 5

Click Save.

Click Copy to, you can copy camera link config to other devices.

11.2.4 Arm Time

Event is armed all-day by default. You can set arm time as needed.

Step 1

In New tab, click Event CFG.

Step 2

Click device and select event type.

Step 3

Slide  to enable event and click Arm Time tab. See Figure 11-5.

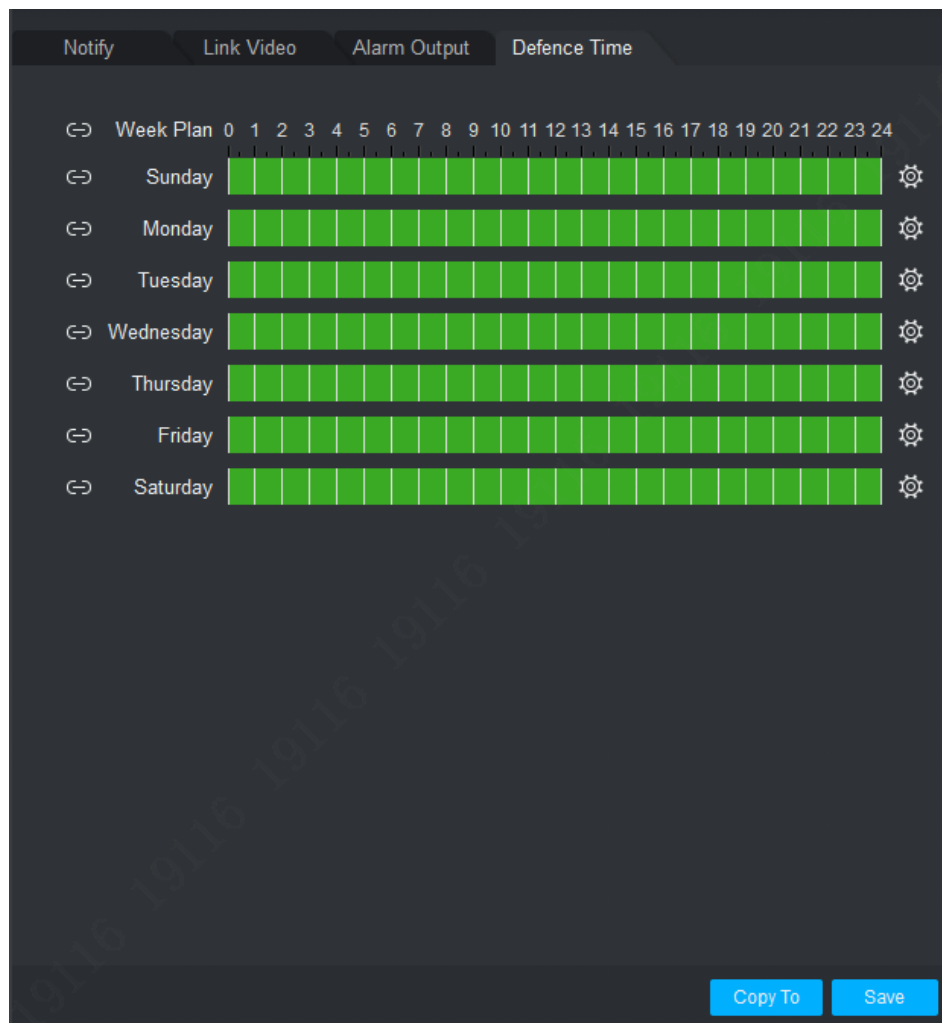



Figure 11-5

Step 4

In corresponding day of week drag mouse to delete to add arm time. You also can

click  of each day of week to set arm time in pop-up box.

Step 5

Click Save.

Click Copy to, you can copy camera arm time config to other devices.

11.3 Event View

You can view the alarm event information, disable event sounds or disable alarm linkage pop video, pause refresh of event information.

In homepage, click  or  in **New** tab, select the Event, see Figure 11-6.

- In the Event interface you can view real-time alarm information, view up to 1000 latest messages, please search historical alarm message in log, see 7 Log Search.
- Select event, you can check Disable sound to disable the alarm sound for event; check Stop link video popup to prohibit pop-up video; check Stop refresh to pause refresh of event.
- Select event, click the Confirm, you can add a description to the event.
- After you handle event or confirm event, you cannot change the status of the event.



After alarm is triggered by IPC with perimeter protection, the reported alarm types are displayed as tripwire-vehicle, tripwire-people, intrusion-vehicle and intrusion-people. For those which fail to support alarm of perimeter protection or AI recognition is not enabled, alarm types can only be displayed as tripwire and intrusion.

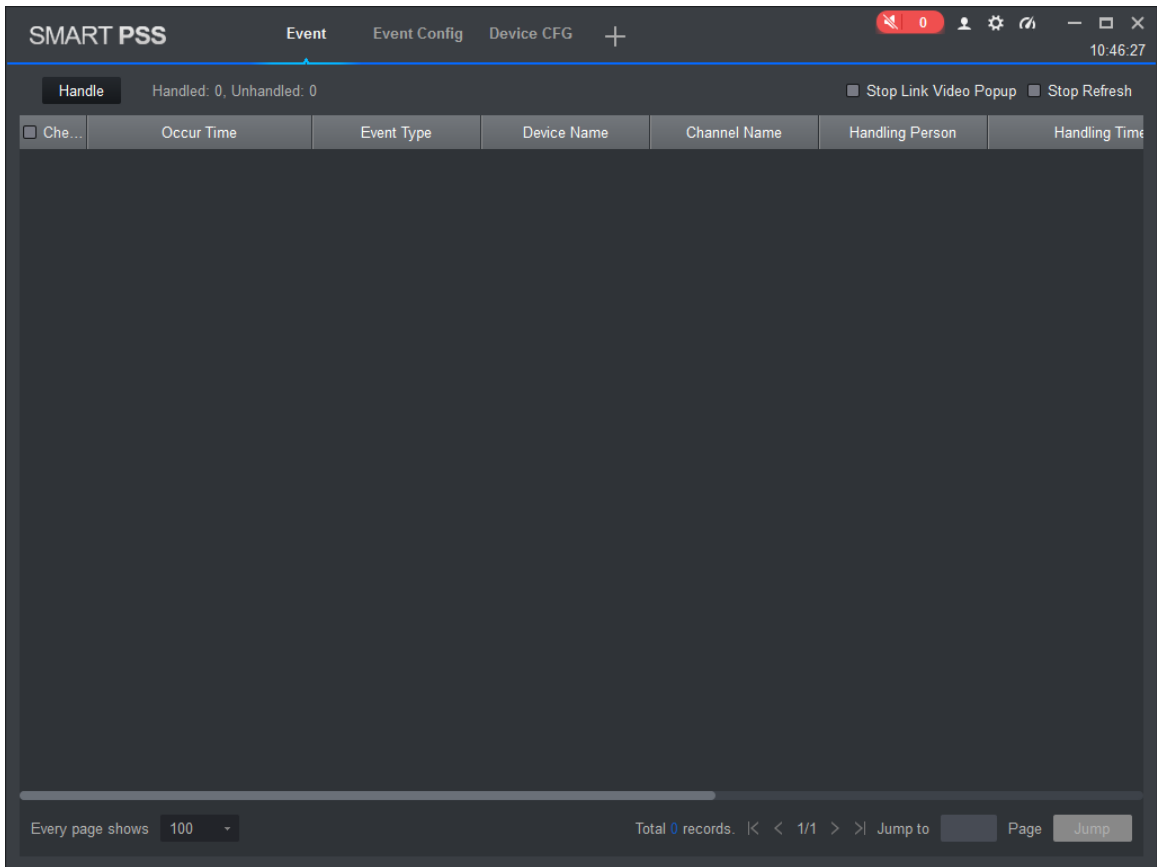

Figure 11-6

12. Video Wall

12.1 Video Wall

You can set video wall layout, live preview on wall, scheme and tour plus playback on wall.

In New tab, click Video Wall, see Figure 12-1.

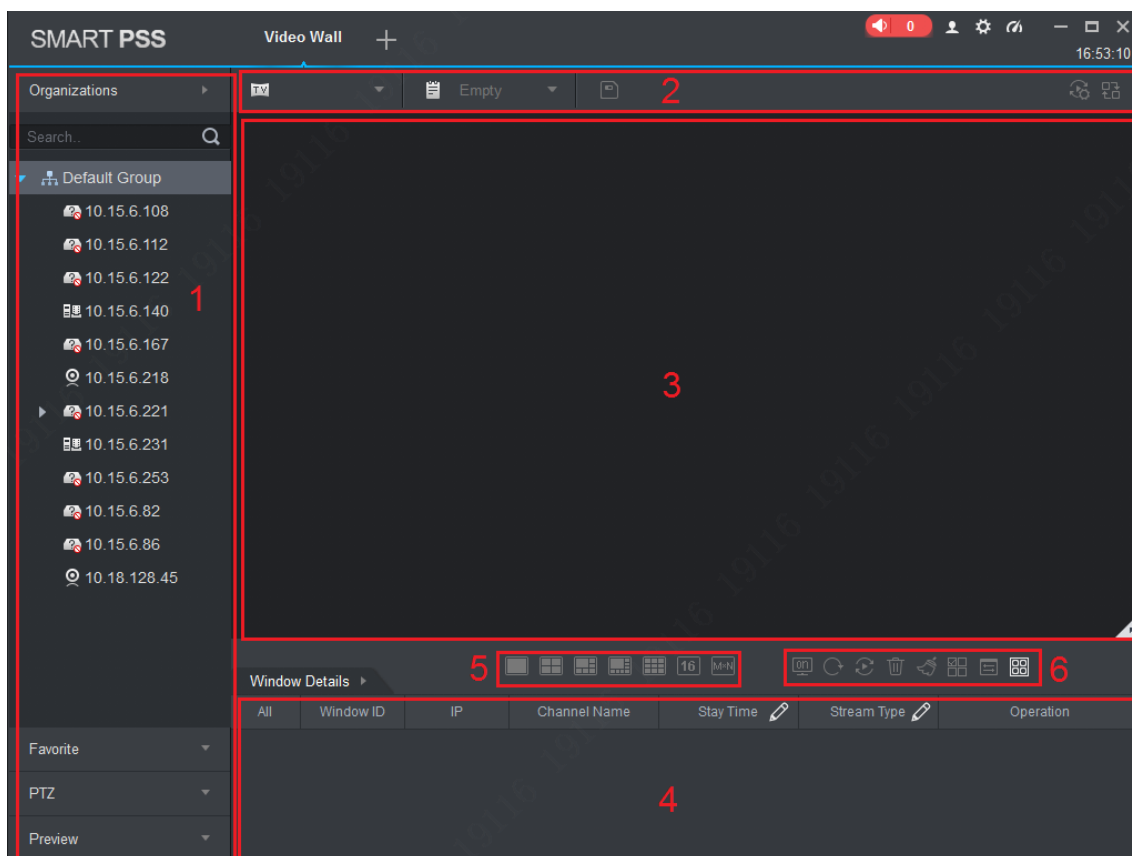









Figure 12-1

SN	Task	Note
1	Device list	<ul style="list-style-type: none"> When set Default Device Tree to Device Tree (by device), the device tree displays device group and channels for the device. When set Default Device Tree to Area Tree (by channel), the device tree displays device channels. <p>See 8 System Config</p>
	Favorites	Collect those channels which need to be frequently monitored, the Same channel can be collected in the different favorites.
	Preview	<ul style="list-style-type: none"> Right click device channel and select Preview, display corresponding device channel in the Preview area. Select window of video wall with bound device channel, in Window Details area>Operation column, click , corresponding video will be displayed in the video preview area.

	Switch stream	<p>You can switch stream through the following two ways.</p> <ul style="list-style-type: none"> ● Right click device channel and select stream type, and set the desired stream. ● Select window with bound device channel, right click to select stream type, and set the desired stream.
	PTZ	<p>There are two ways you can enter PTZ control interface.</p> <ul style="list-style-type: none"> ● Click PTZ area, the system displays the PTZ control interface. ● Select window with bound device channel, select the right to switch to the head, the system pop-up PTZ control interface. <p>See 4.8 PTZ</p>
2	Video wall	<p>Set video wall layout and channel video preview on the wall.</p> <p>See 12.3 Set Video Wall and Output</p>
	Scheme tour	<p>Add scheme, set tour and enable tour.</p> <p>See 12.4 Scheme Tour on Video Wall</p>
3	Clear video source	Select window with bound device channel, right click to select Clear Video Source.
	Bottom	Select window with bound device channel, right click to select Bottom, to set the video wall to the bottom.
	Set wall mode	Select window with bound device channel, right click to select Wall mode>Live or playback on wall, set video wall mode.
	Open Audio	Select window with bound device channel, click  at the upper right corner of the screen, to turn on audio.
	Paste	Click  the window will occupy the physical screen of the window.
	Maximize	Click  , the window will fill the window in the whole screen.
	Close	Click  to close the window.
4	Window details	In Window Details area of the window you can view the channel information, set tour video channel time span and stream type, preview video channel, adjust order of video channels or delete unwanted video channel.
5	Set video wall layout	<p>Click  to switch video wall display layout.</p>
6	Function bar	<ul style="list-style-type: none"> ● Click  in the pop-up screen switch box, select screen on or off screen.









		<ul style="list-style-type: none"> ● Click  to refresh the screen information. ● Choose bound NVR device or device channel video wall in group, click  to open tour; click  to close tout. ● Click  to delete the selected window. ● Click  to clear the screen. ● Click , you can select multiple windows, then the icon  changes to ; click a window. ● Click  to display window number and video wall number.
--	--	---

Chart 12-1

12.2 Config Favorites

You shall place commonly used monitoring or linked channel to a same favorites for easy management and output. In device list, click Favorite tab, see Figure 12-2.

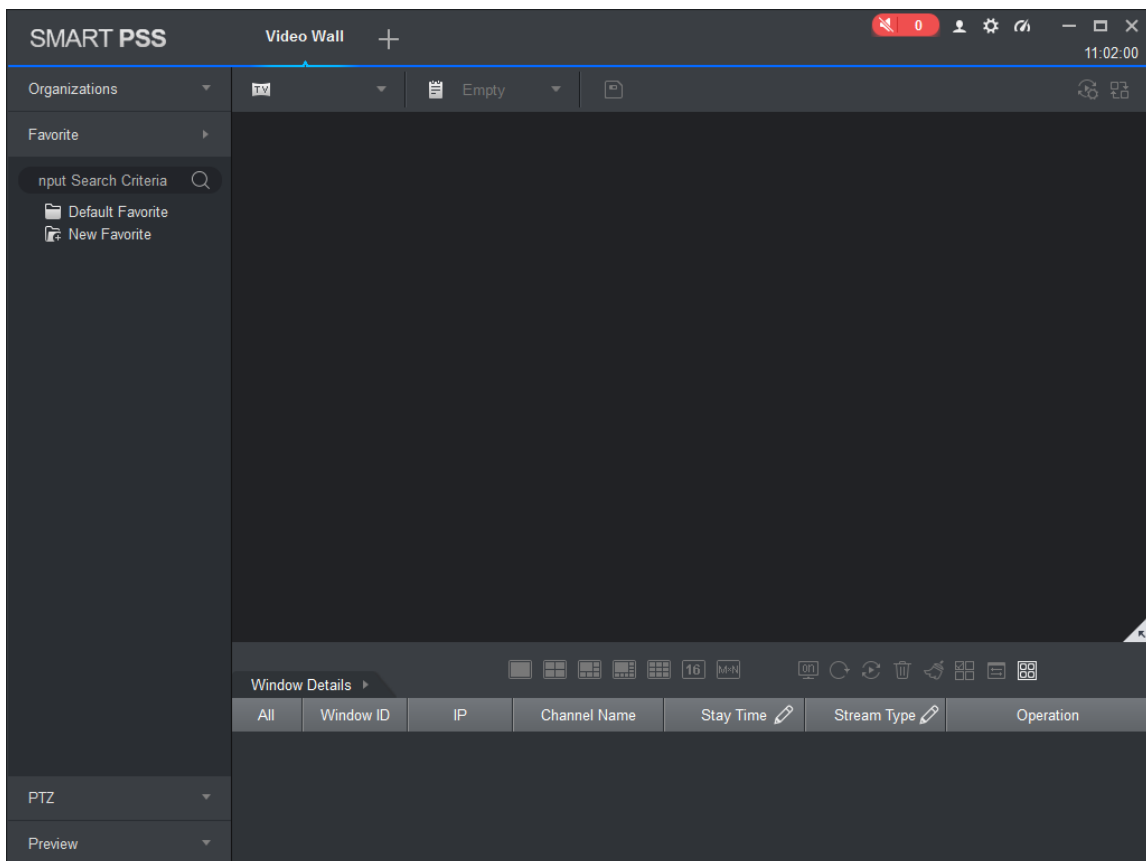

Figure 12-2

12.2.1 Add Favorite

Step 1

In Video Wall interface, right click on favorite list and select Manage Favorite, see Figure 12-3.

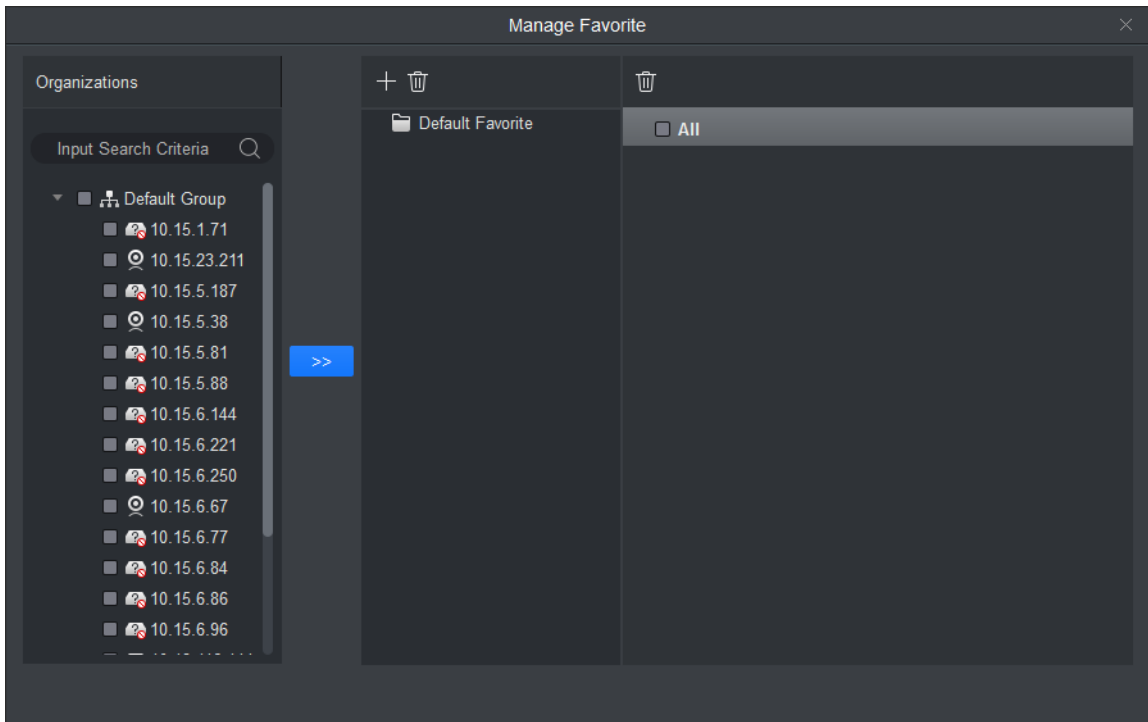



Figure 12-3

Step 2

Click . See Figure 12-4.



In Figure 12-2, you can click New Favorite, to open Figure 12-4.

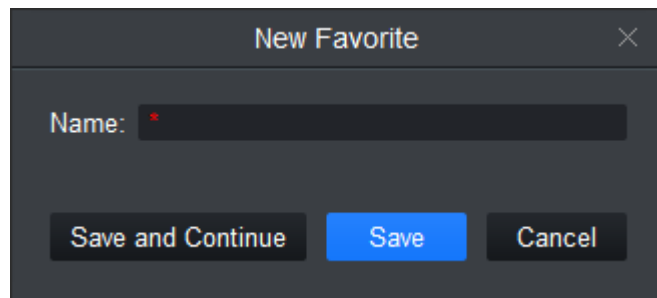

Figure 12-4

Step 3

Enter name, click Save.



If you want to add more favorites, click Save and Continue to continue adding.

Step 4

Add channel to favorite, see Figure 12-5.

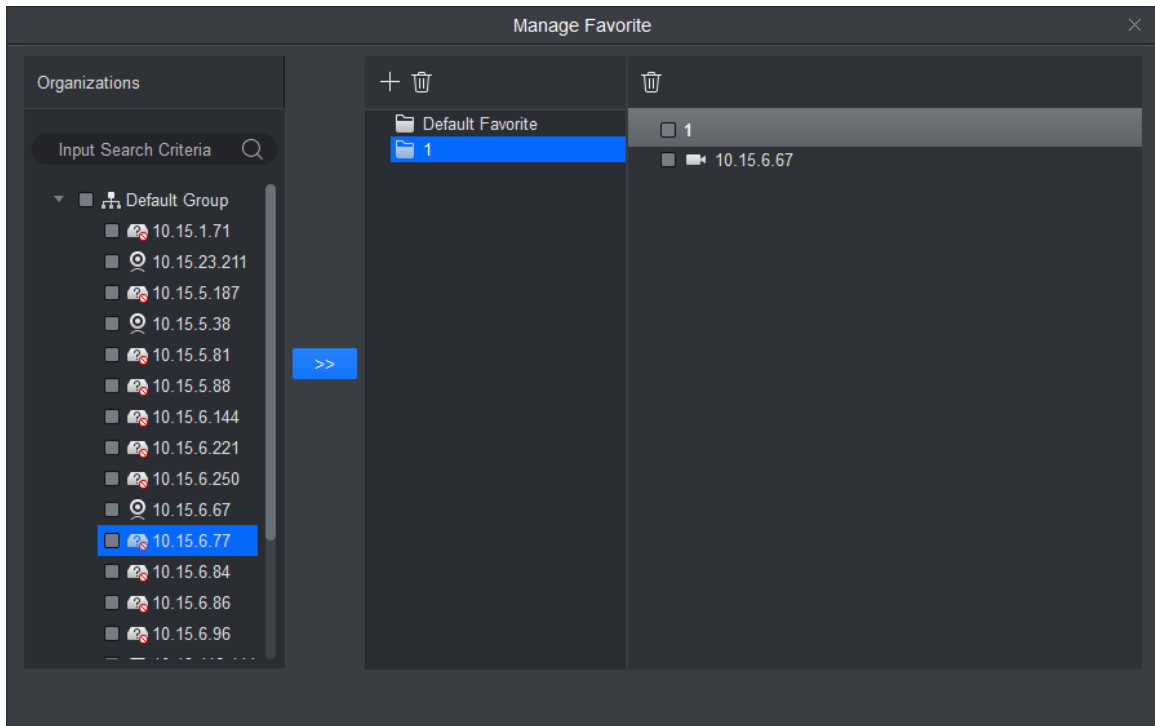



Figure 12-5

1. Select channel on organization tree.
2. Select favorite in favorite list.
3. Click  to complete adding.

Step 5

Click  of Manage Favorite interface to exit.

12.2.2 Delete Favorite

Step 1

In Video Wall interface, right click in Favorite area, and select Manage Favorite.

See Figure 12-3.

Step 2

Select favorite, click  next to it and delete.



In Figure 12-2, you can click favorite you want to delete, and right click it.

12.2.3 Delete Channel

Step 1

In Video Wall interface, right click in Favorite area, see Figure 12-3.

Step 2

Select favorite to delete.

Step 3

Select channel, click  to delete channel.



In Figure 12-2, you can click  of channel you want to delete, and select channel, right click delete this item. Confirm your selection.

12.2.4 Change Favorite Name

In Figure 12-2, click favorite name you want to modify, right click Change Favorite Name, enter new name.



You cannot change name of default favorite.

12.3 Set Video Wall and Output

Condition

- Decoder and video wall are connected successfully.
- Add encoder, see 3 Devices

Operation Steps



Step 1

Set video wall layout.

1. In video wall interface, click  and in pop-up box click +. See Figure 12-6.



Select multiple screens, click  to add splicing screen; select splicing screens, click

 to cancel splicing screen; click  to clear screen config.

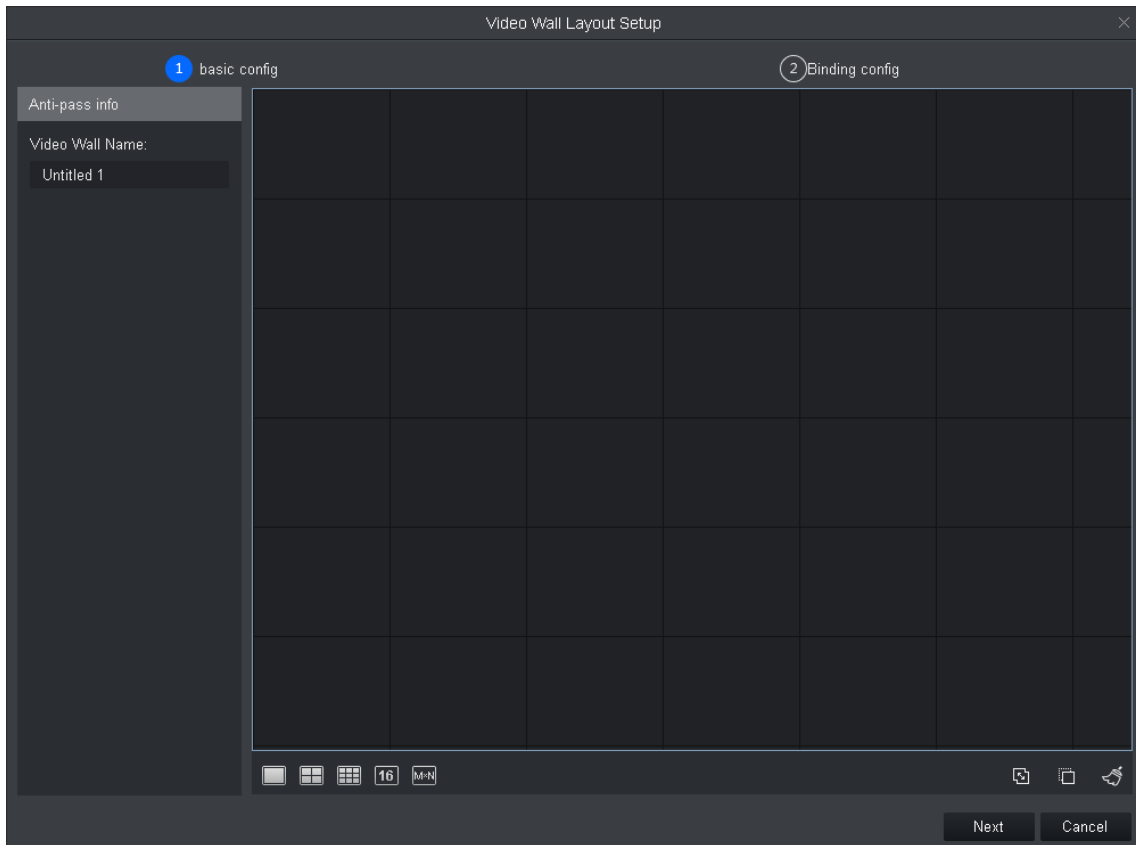



Figure 12-6

2. In basic config interface, set video wall name, select   Layout, and click in video wall, to add video wall layout.
3. Click Next. See Figure 12-7.

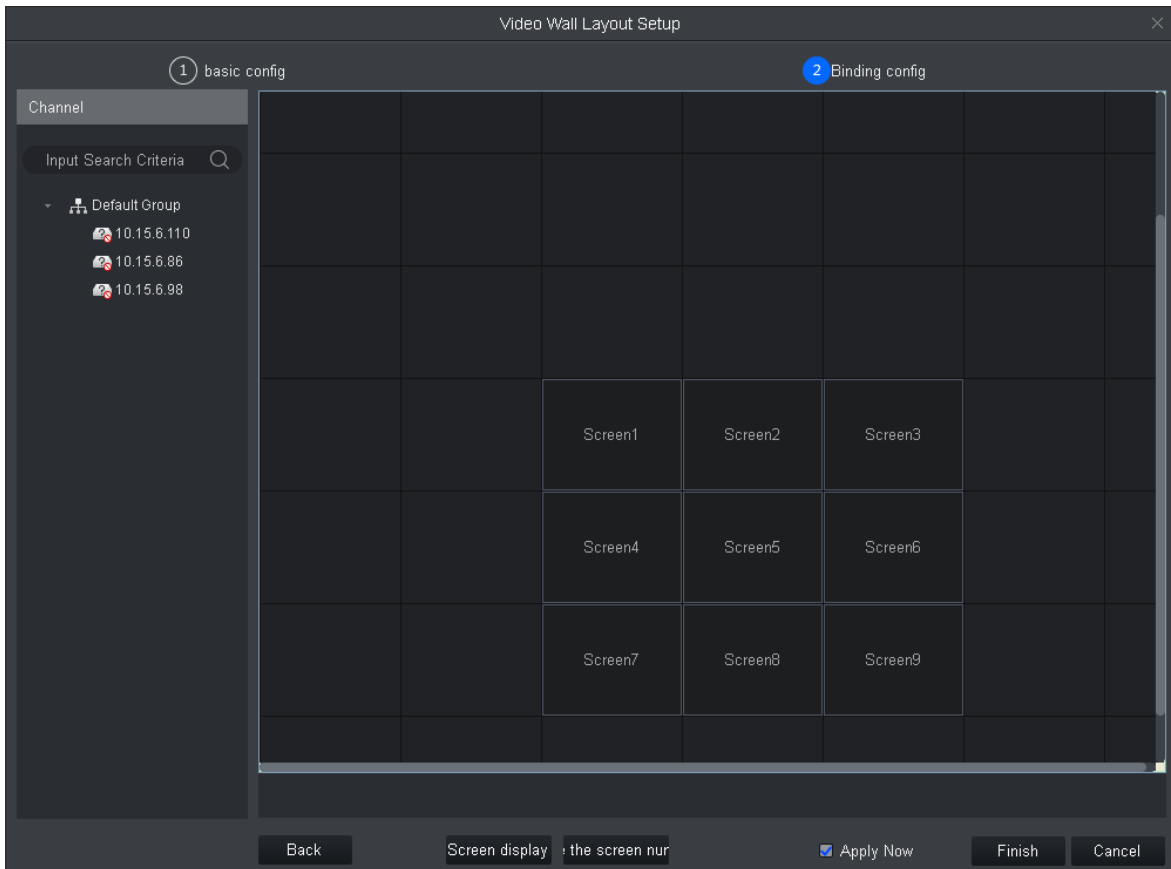

Figure 12-7

4. Drag decoder into slot, to bind decoder and screen.



- Click screen display, to show screen no., click Hide number to hide screen number.
- If you want to cancel bound decoder slot, right click corresponding screen and select Cancel.

5. Check Apply Now to immediately use this config; click Finish to complete setup.



Check **Apply Now**, then return to video wall interface to enable this config.

Step 2

Preview channel video on wall.

1. In Video Wall interface, click layout you want, and slide , to enable video wall layout.

See Figure 12-8.



In pop up box, select video wall layout, click  to modify video wall layout, click



to delete layout. See Figure 12-8.

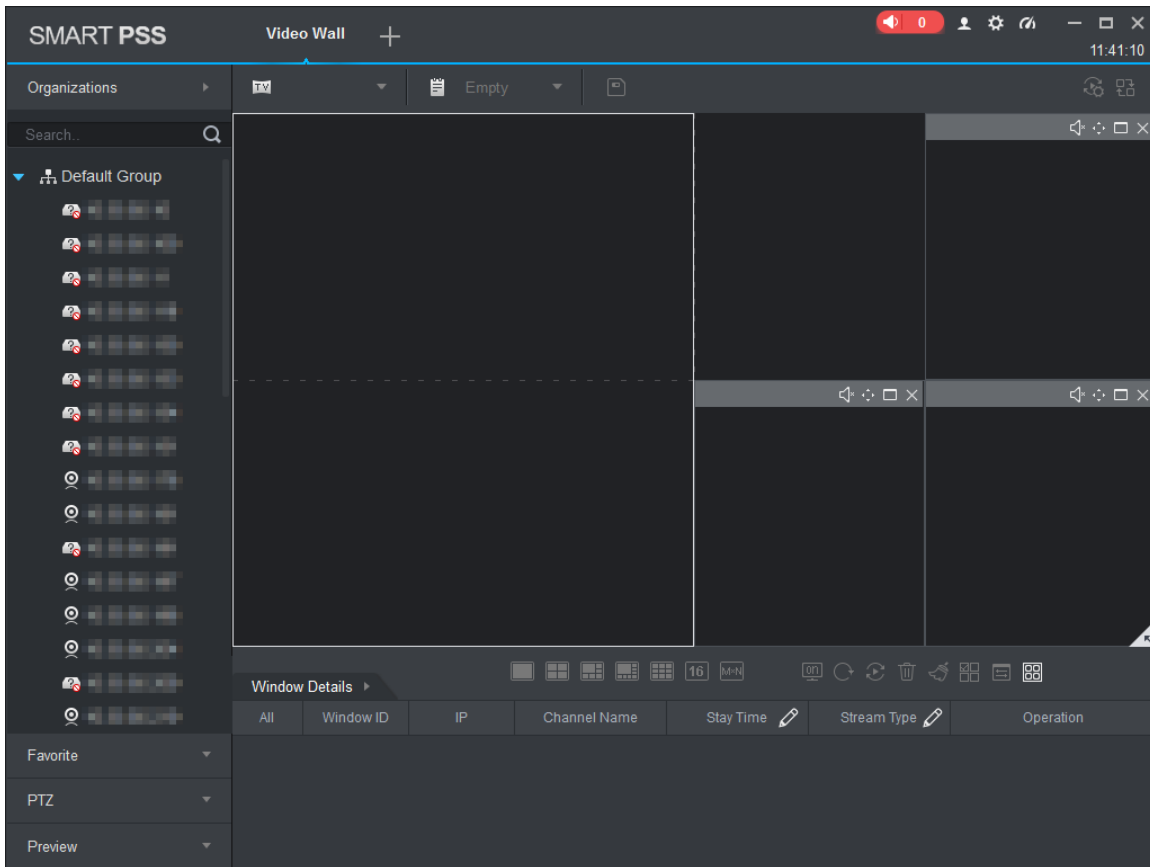

Figure 12-8

2. Drag device channel into screen, bind channel and screen.

Video of corresponding channel is played in the screen, and channel info will be show in Window Details area.



- Via window split, you can enable window in screen.
- When the device supports roaming, you can drag window randomly among all screens.
- When you drag NVR to the screen, then all channels of NVR are toured on video wall. You can view tour window channel info in Window Details area. You can set tour channel time span and stream type and preview channel video in Operation column, adjust channel order or delete channel.

12.4 Scheme Tour on Video Wall

Step 1

Add plan.

1. Select video wall layout and bind channel.
2. Click . See Figure 12-9.

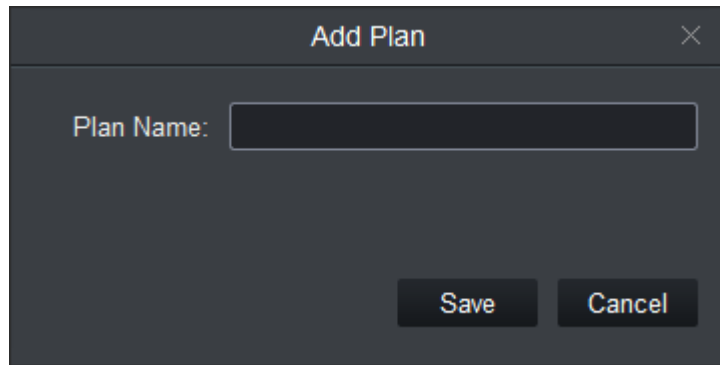



Figure 12-9

3. Set plan name, click Save.
Repeat step 1 to 3 to add more plans.

Step 2

Set scheme tour.

1. Click . See Figure 12-10.

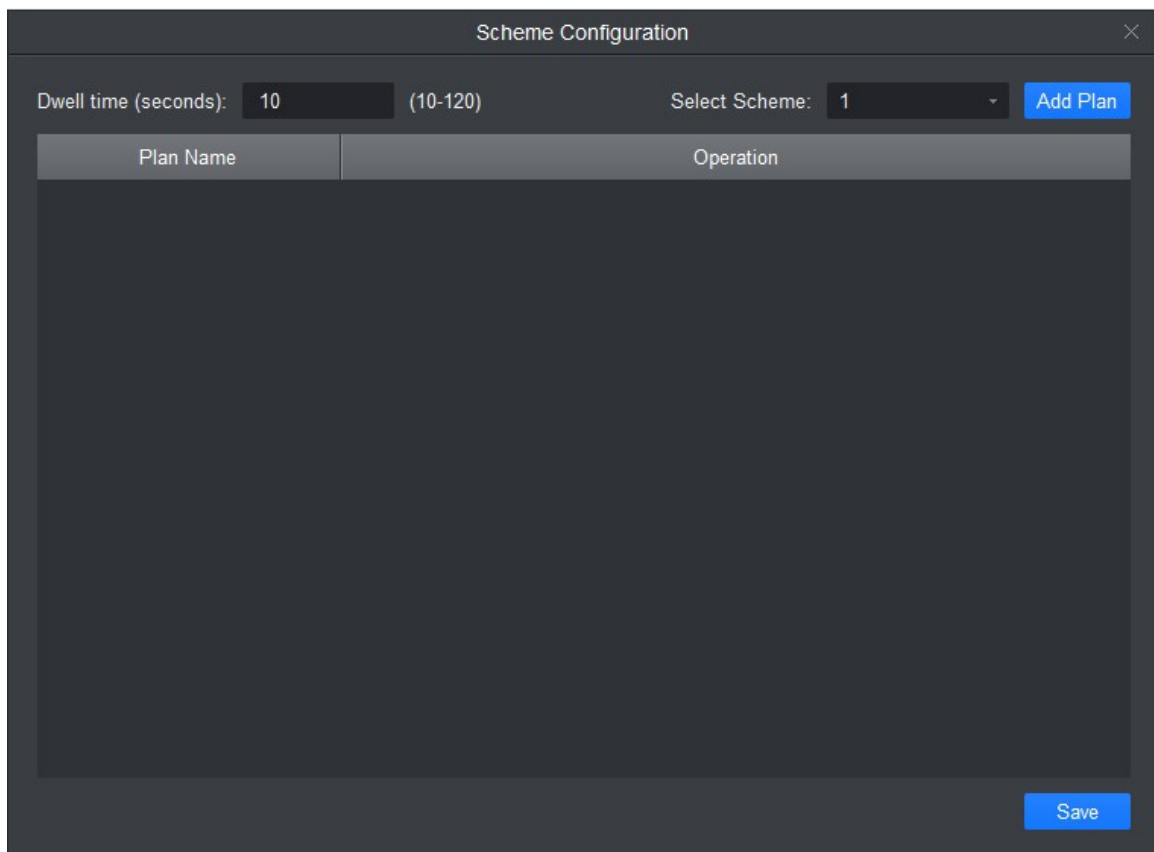

Figure 12-10

2. Set time span and select scheme, click Add Scheme. Repeat this step to add more schemes.



You can adjust scheme order and delete scheme in Operation column.

3. Click Save.

Step 3

Click  to enable scheme tour.

Click  to disable scheme tour.

12.5 Playback on Video Wall

Playback device channel record on video wall.

Condition

- Complete video wall config.
- Record exists in device channel.

Operation Steps

Step 1

Select screen with bound device channel, right click Video Wall>Playback on Video Wall.

See Figure 12-11.

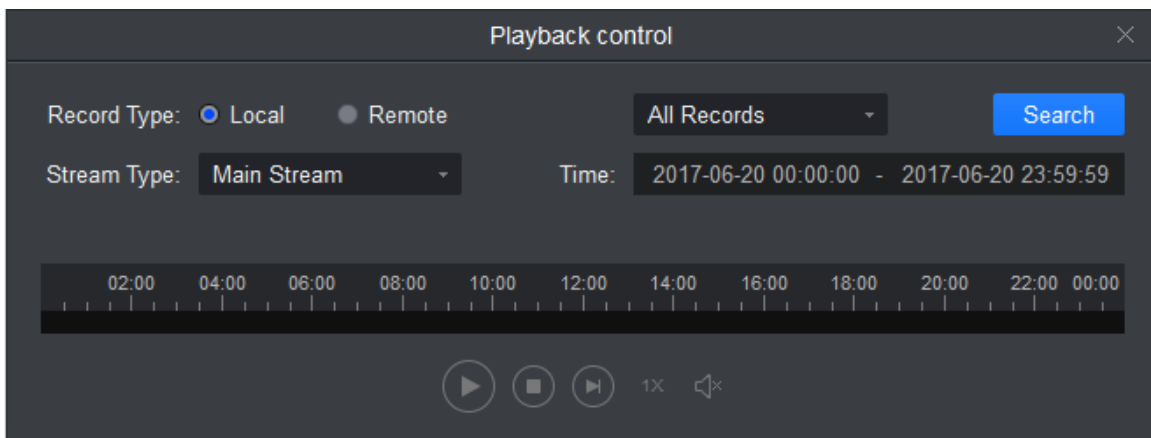

Figure 12-11

Step 2

Select record type and stream type, and set time.

Step 3

Click Search.

Step 4

Select record file, click  to playback record.

12.6 Operating Video Wall by NKB1000

By NKB1000, you can enable video wall window, bind video source, delete video source, maximize window and restore max window etc.

Preconditions

- The target device's number has been set and recorded.
- The keyboard is connected to PC where SmartPSS software is located.
- Logged in SmartPSS software and enabled video wall interface.

Operation Steps

Step 1

Connect to power, the power indicator is on. The welcome interface will be displayed on the LCD after starting normally, click OK or Setting and login interface is displayed.

Step 2

Input Username and Password by the joystick, and click OK. The main interface is displayed.



The default password of admin is 888888.

Step 3

Select Mode as Video Wall by joystick.

Step 4

Operate video wall interface. For different functions, see Chart 12-2.

Function	Description
Enable window	First click Window Number, and then Split, enable corresponding window number on the video wall interface. Window number means the number of windows which are opened on the video wall interface.
Bind video source	First click Window Number and then ID, select the window which needs to bind video source, and then click Device No. and Channel to bind video source. Window number starts from upper left window 1 and then from left to right, then up to down.
Clear video source	First click Window Number and then ID, select the window which needs to clear video source, and then click 0 and Channel to clear video source. Window number starts from upper left window 1 and then from left to right, then up to down.
Max window	First click Window No. and then ID, select video wall window, click FN button and the window is displayed with max size. The window No. starts from window 1 at upper left corner and counts from left to right, up to down.
Restore max window	Press FN button or press 0 and FN button successively, max window is restored.

Chart 12-2

13. People Count

13.1 People Counting

You can search and export people count result, contrast by time and channel and export people count data.

Condition

- Enabled people count function, see 4.4.4 People Counting
- People count data exist in device.

Operation Steps

Step 1

In New tab, click People Count. See Figure 13-1.

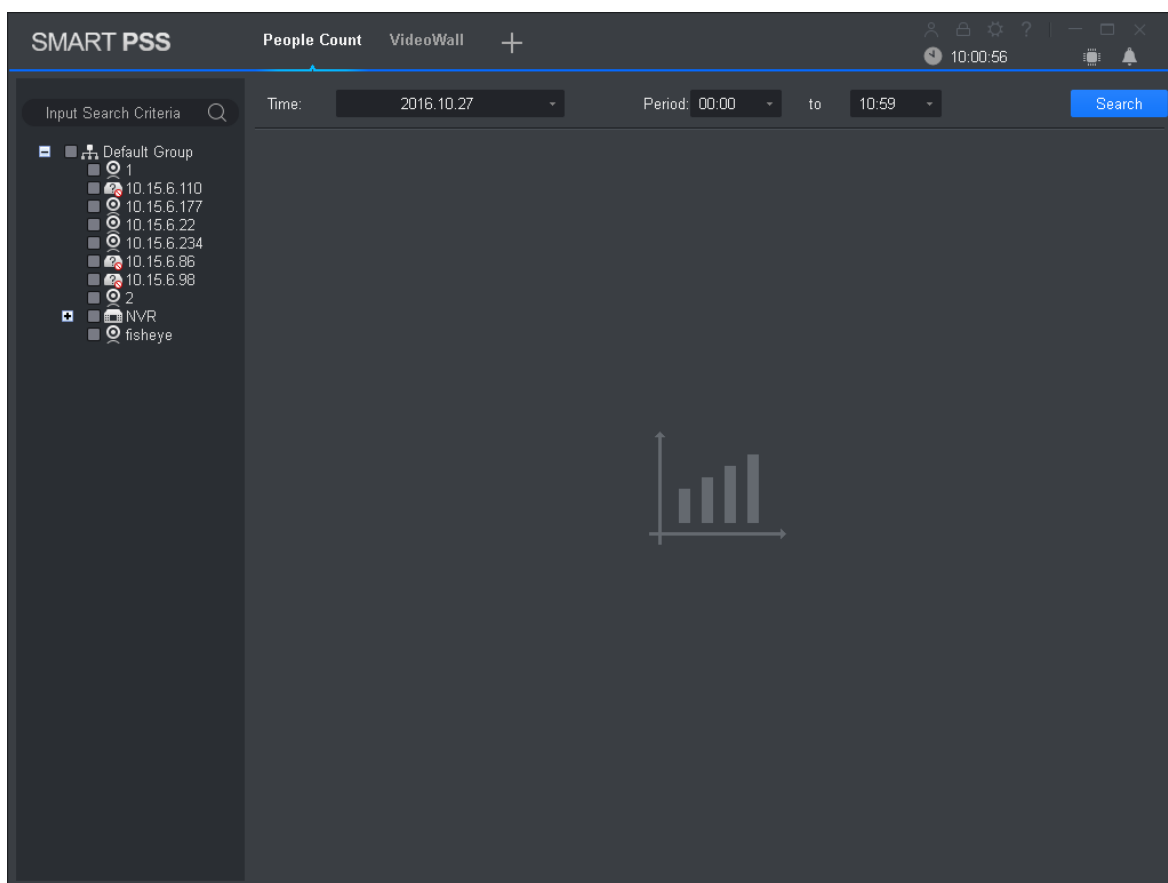

Figure 13-1

Step 2

Select channel with people count data, and set time and period for search.



- You can search people count data by date, time, year or month.
- If you select multiple channel, then it will search data of these channels in search period

Step 3

Click Search.

The system shows people count result in this period, see Figure 13-2.

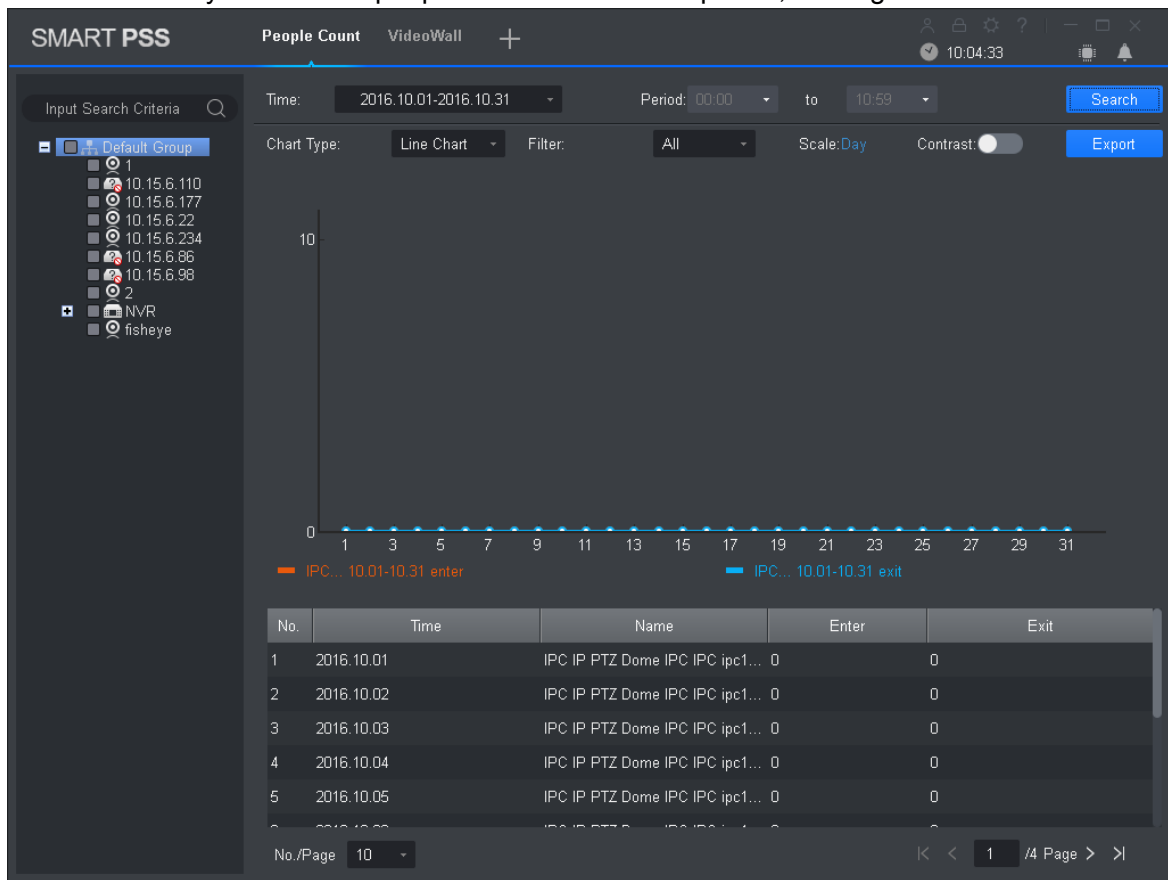



Figure 13-2

Step 4

Contrast people count results.

Select statistical figure type, set filter to be ex Enter or Exit, and click  to enable contrast. See Figure 13-3.

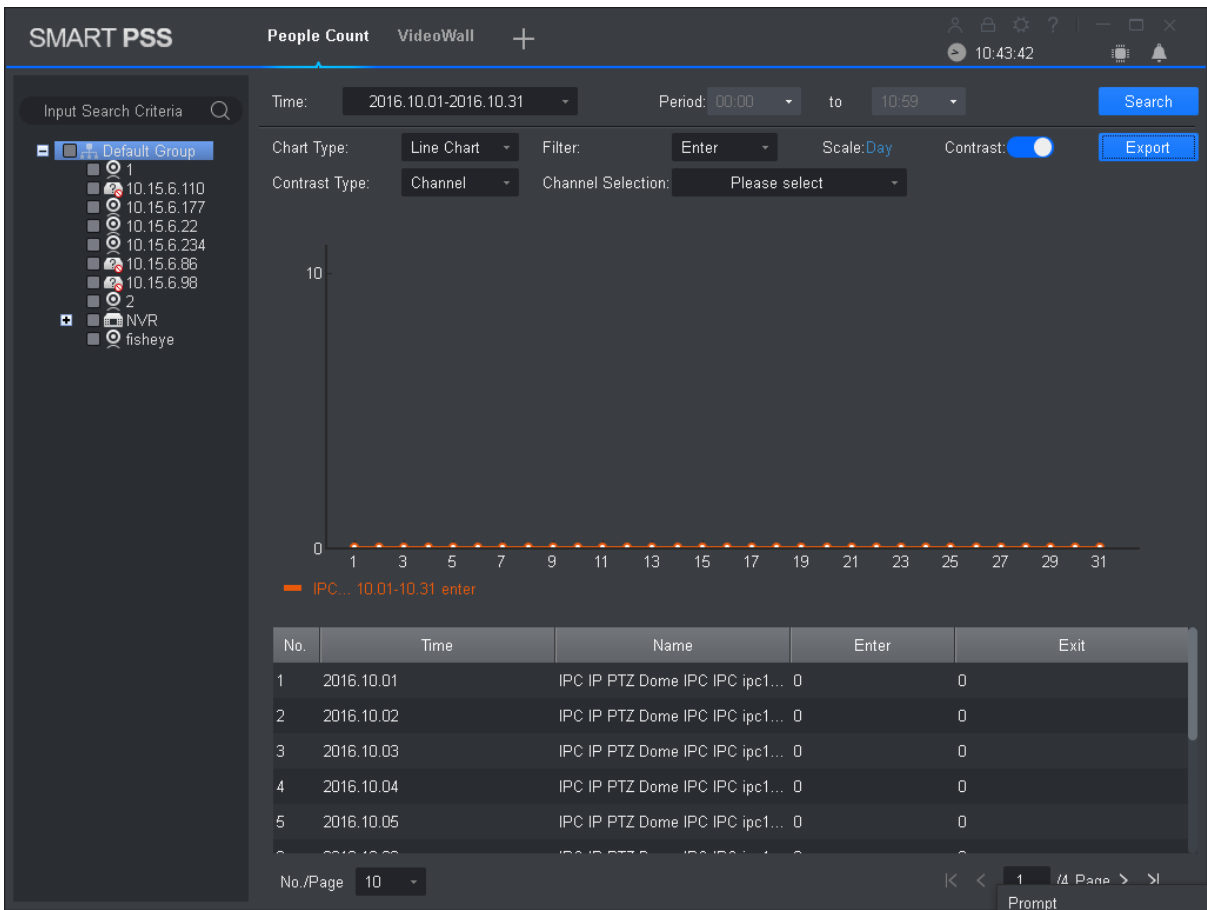

Figure 13-3

Step 5

Set contrast type to Channel and select channel for contrast. This contrasts people count results of different channels within the same period. Set contrast type to Time and select time for contrast. This contrasts people count results of different periods for the same channel. System shows result.

13.2 Flow Statistics

Here you can search and export flow statistics results, export people counting data by time or channel comparison.

Precondition

Flow statistics function is already enabled; refer to camera user manual for more details.

Operation Steps

Step 1

Click  and select People Counting on the interface.

The People Counting interface is displayed. See Figure 13-1.

Step 2

Click Flow Statistics tab.

The interface of Flow Statistics is displayed. See Figure 14-1

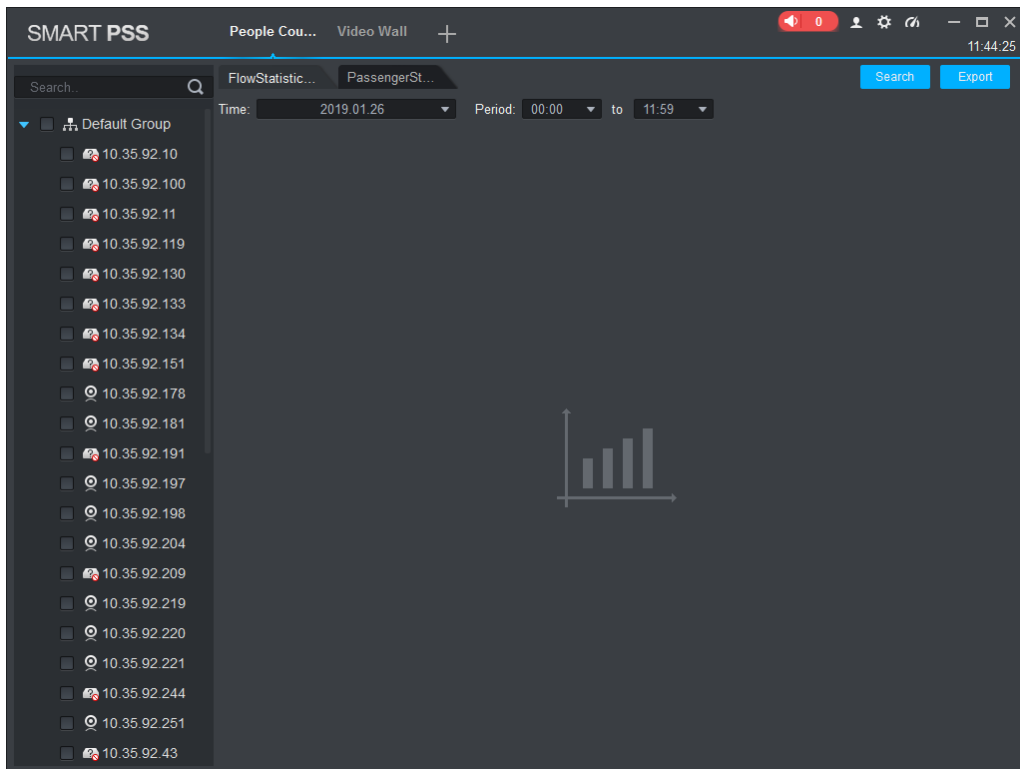

Figure 13-4

Step 3

Select the channel with flow statistics data and set time and period which need to be searched.



- You can search flow statistics data by date, period, year or month.
- If several channels are selected, then you can search summary data of corresponding people counting of the channels within the period.

Step 4

Click Search.

The system displays the flow statistics results of the period.

You can set display form of statistics graph according to Statistics Graph Type, then you can filter display contents of flow statistics graph.

Click Export and you can export result data of flow statistics.

14. Heat Map

You can search object moving accumulated density in device monitor image.

Condition

- Device has enabled heat map statistics.
- Heat map data exist in device.

Operation Steps

Step 1

In New tab, click Heat Map. See Figure 14-1.

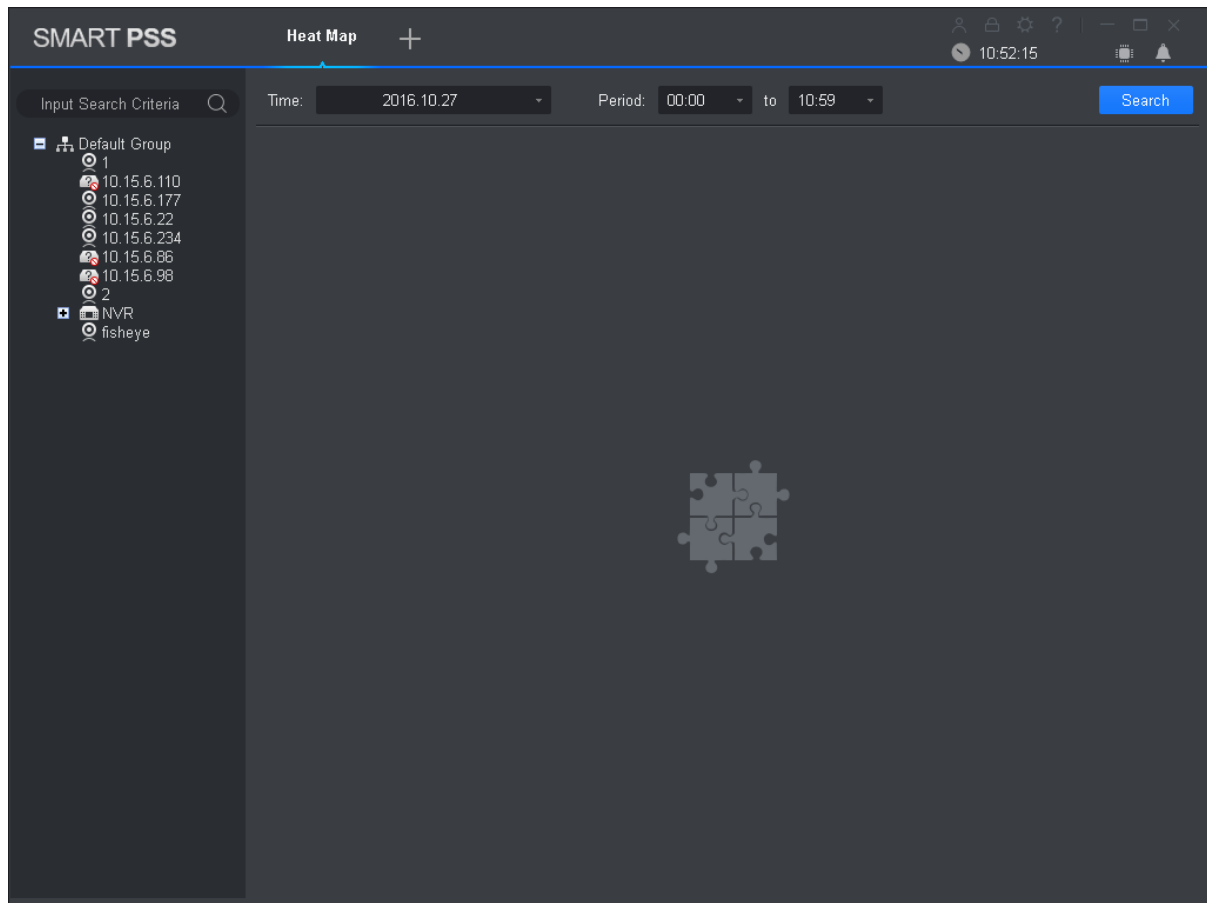

Figure 14-1

Step 2

Select camera with existing heat map data, and set search time and period.



You can search heat map data by date, period, or day of week.

Step 3

Click **Search**. System shows object moving accumulated density result of this period monitored by device.

Click **Export** to export heat map date.

15. PC-NVR

After PC-NVR is added, you can manage disk, manage channel, set record plan and view version.

Condition

- PC-NVR is installed and running now.
- See 3 Devices to add PV-NVR.

15.1 Disk Manager

Step 1

In New tab, click PC-NVR.

Step 2

Select HDD tab, see Figure 15-1.

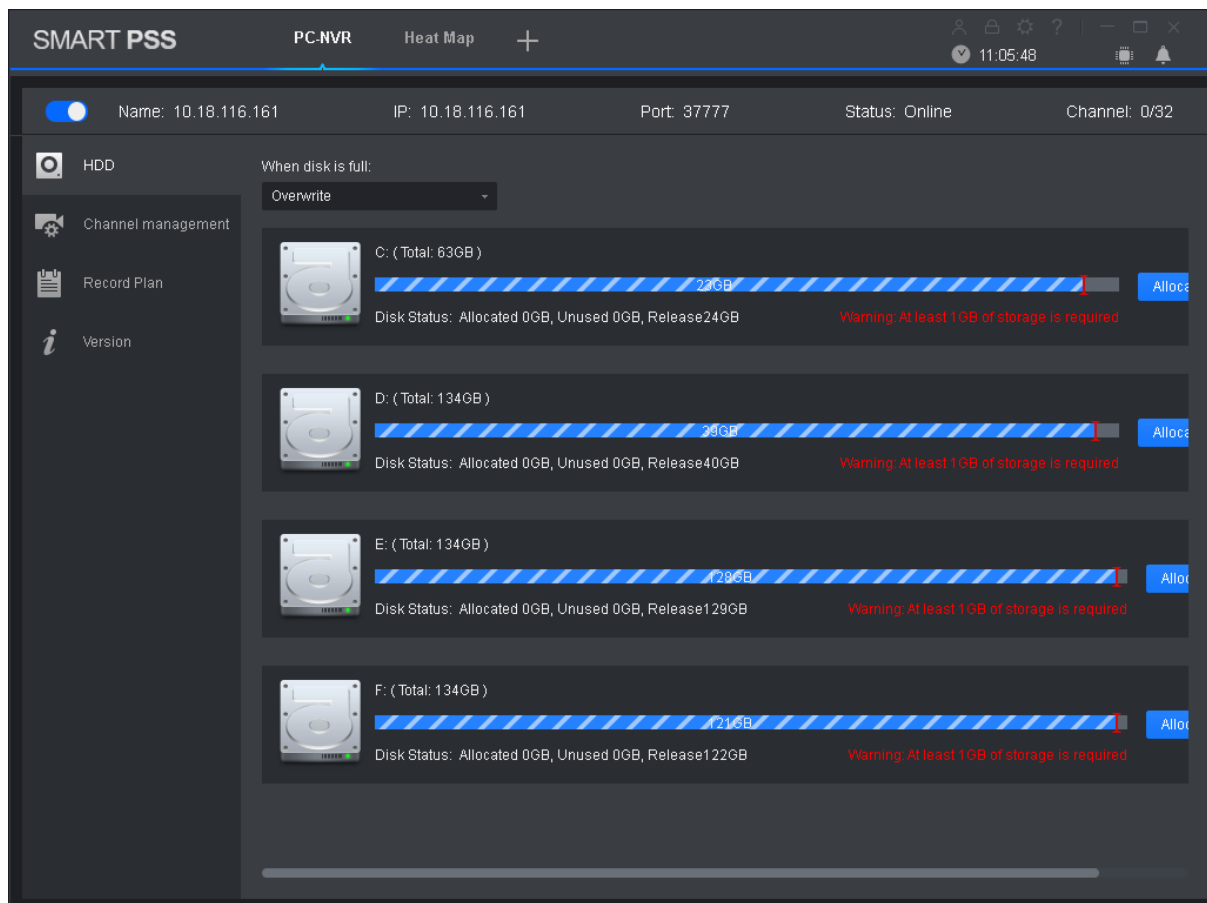

Figure 15-1

Step 3

Select record plan when HDD is full, and set disk space, click Allocate.

System pops up info box, click OK.



Re-allocate disk space, system will delete all record files on the disk, be careful!

15.2 Channel Management

Set channel info to pass PC-NVR record plan.

Step 1

In New tab, click PC-NVR.

Step 2

Select Channel Management tab, see Figure 15-2.

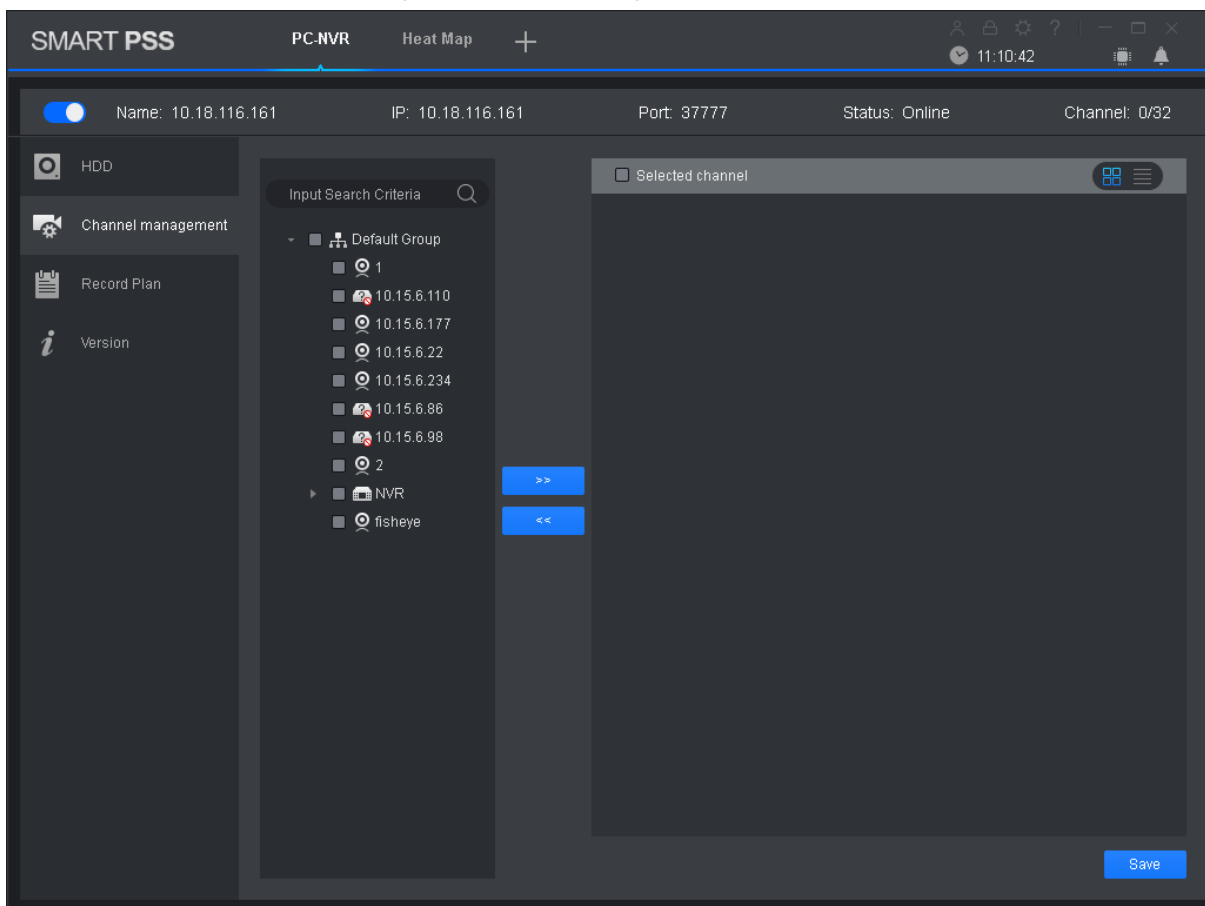
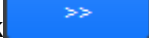





Figure 15-2

Step 3

In device list select device channel, click . System will add the selected device channel to list on the right.



- Click  to add device channel and shown in thumbnail, click  to add device channel and shown in list.
- If you delete unwanted device channel, check box in front of one device channel

or check Selected channel to select all channels, click  to delete.

Step 4

Click Save.

15.3 Set Record Plan

For the selected channel, set record schedule, motion detect, alarm, MD& alarm, or smart record plan.

Step 1

In New tab, click PC-NVR.

Step 2

Select **Record Plan** tab. See Figure 15-3.

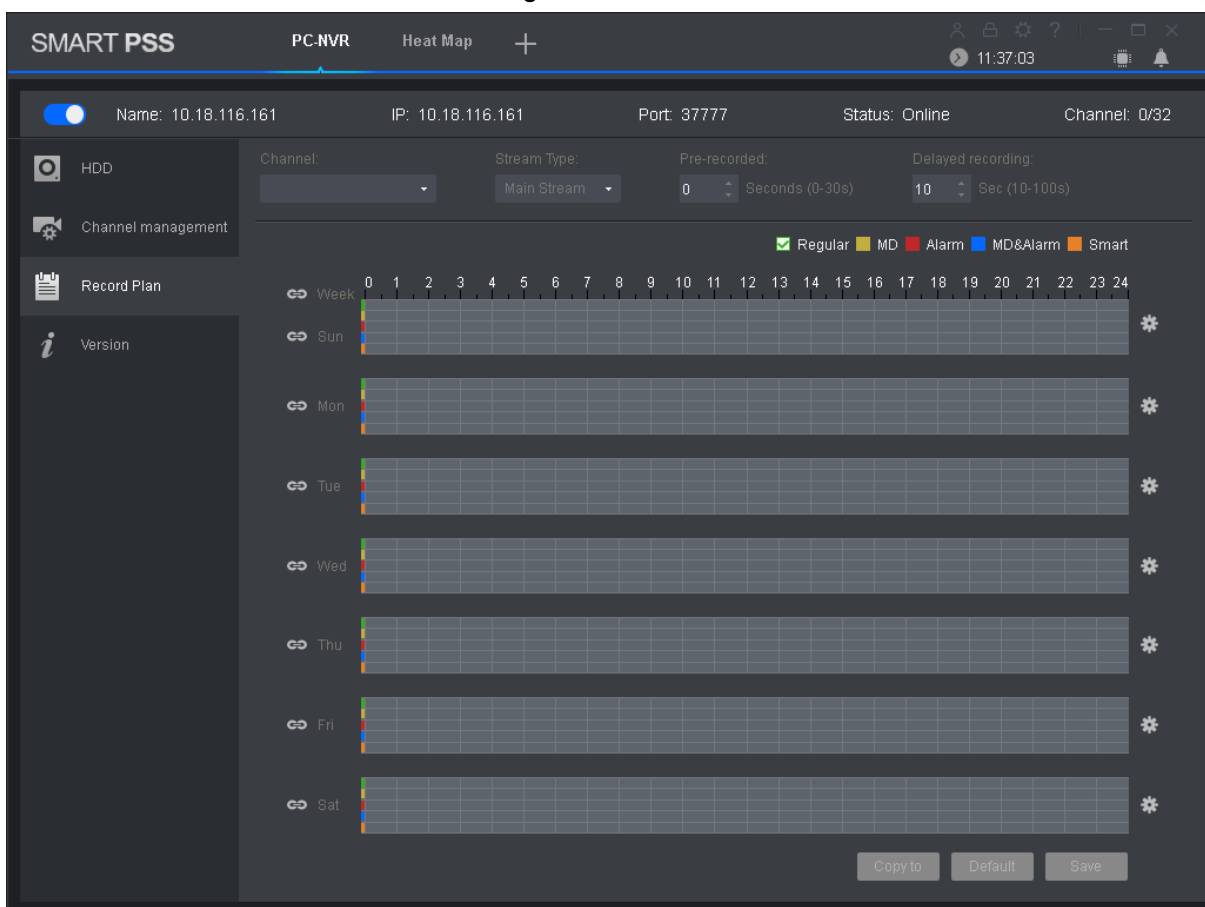

Figure 15-3

Step 3

Select channel to set record plan, select stream type, set pre-record time and delay record time.

Step 4

Check record type, and select record time in corresponding day of week bar.



You can click  next to each day of week bar, and in pop-up box set record type and period.

Step 5

Click Save.



- Click Copy to, and check device channel, you can copy the record plan in this channel to other device channel.
- Click Default to restore default status of device channel record plan.

15.4 Version Info

You can view PC-NVR name, storage path and version.

Step 1

In New tab, click PC-NVR.

Step 2

Select Version tab, see Figure 15-4.

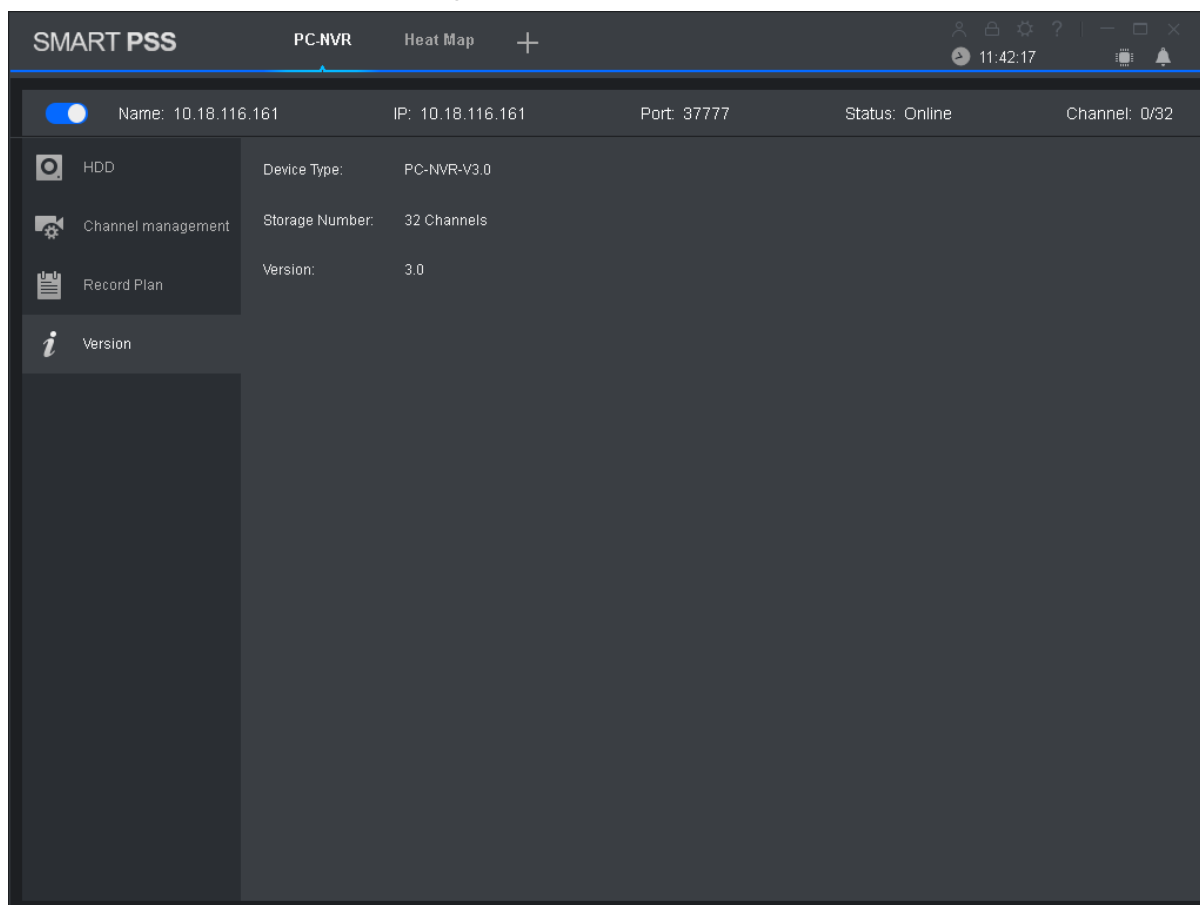



Figure 15-4

15.5 Modify Port

Step 1

Click  at the lower-right corner of PC, select PC-NVR Setting. See Figure 15-5.

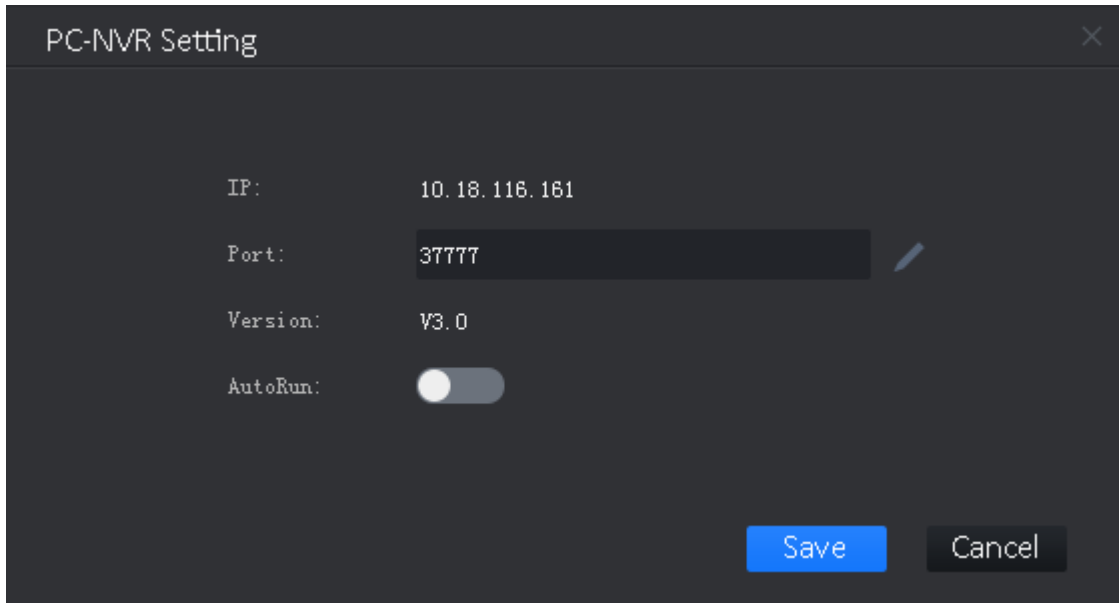



Figure 15-5

Step 2

Click  and enter port no. you want.

If you slide  to enable auto ON, after PC boots up, PC-NVR will be ON automatically.

Step 3

Click Save.

15.6 Modify Password

Step 1

Click  at the lower-right corner of PC, select Password Setting. See Figure 15-6.

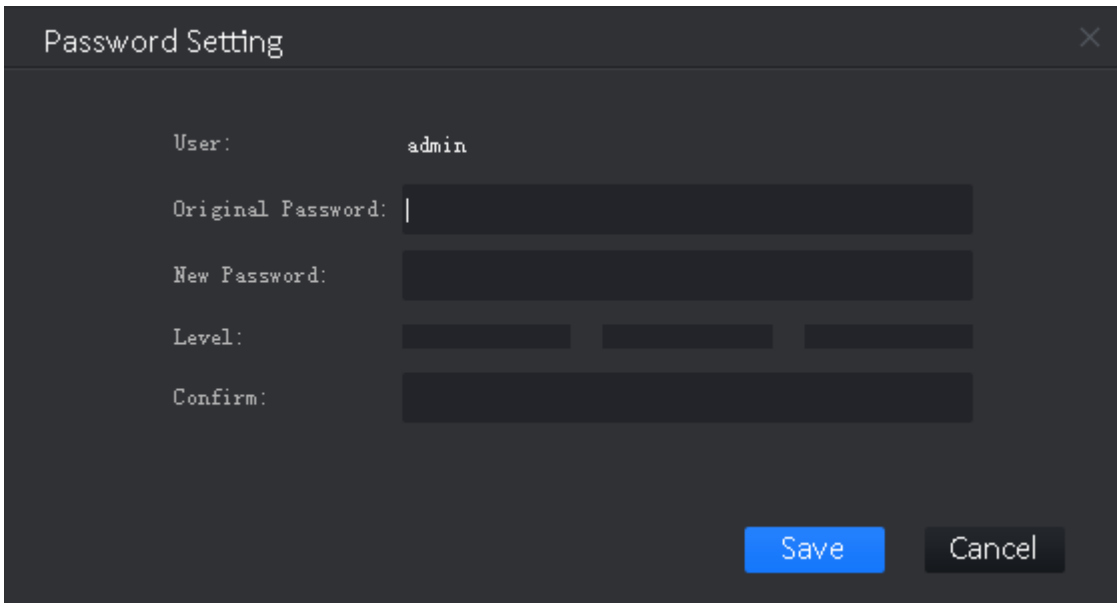

The image shows a 'Password Setting' dialog box with a dark background. At the top left, the title 'Password Setting' is displayed, and at the top right, there is a close button (an 'X' icon). The dialog contains the following fields and controls:

- User:** A text field containing the value 'admin'.
- Original Password:** A password input field with a vertical cursor at the beginning.
- New Password:** A password input field.
- Level:** Three radio button options, all of which are currently unselected.
- Confirm:** A password input field.
- Buttons:** At the bottom right, there are two buttons: a blue 'Save' button and a dark grey 'Cancel' button.

Figure 15-6

Step 2

Enter original password, and enter new password, confirm new password.

Step 3

Click Save.

16. Access

SmartPSS integrates access control device with effective management and configure of device. It achieves modularization of access business and integrates access with video link and e-map.



- Access controller must be added into SmartPSS client, please refer to device adding steps in **3 Devices**
- Access controllers are set on SmartPSS, including network, user management, time config and update. See **10 Device Config**

Click  in New Function interface, select Access.

16.1 Console

Step 1



In Access interface, you can click  See Figure 16-1.

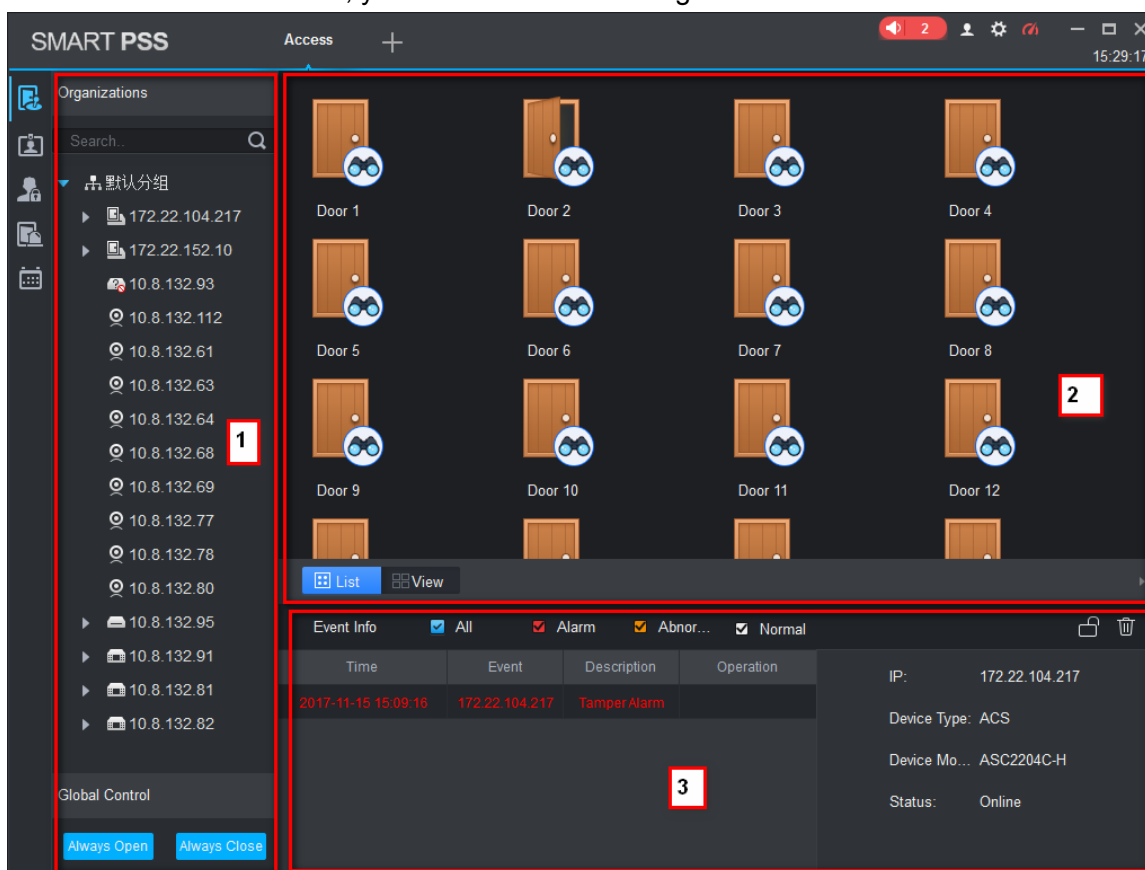

Figure 16-1

No.	Parameter	Note
1	Organizations/ Zones	<p>Include organization tree or zone, right click in blank area to switch.</p> <p>Organization tree has the following operations:</p> <ul style="list-style-type: none"> ● In organization tree blank area, right click to create group (same level with default group), switch organization tree or zone, sequence. ● Right click group to create group (create group under selected group), rename group, open or close all, new map, delete group (excluding default group). ● Right click access control device node to monitor, extract card info, sync data and reboot device. ● Right click access control channel to support unlock, lock. <p>Global control has one-click NO/NC of all access control channels under emergency.</p>
2	List/View	<p>List: Access status display and control.</p> <p>View: Video/e-map preview and control.</p>
3	Event	View event: Access alarm event, normal event and abnormal event.

Chart 16-1

16.1.1 Organizations/Zones

16.1.1.1 E-Map

E-map supports:

- Drag access control/video channel
- Set range of monitoring
- Set transparency of monitoring range.
- Add hot zone, max 3 levels of zones
- Re-edit map.

See 4.3 E-Map

16.1.1.2 Device Control

16.1.1.2.1 Access Control Device

Right click access control device node, see Figure 16-2.

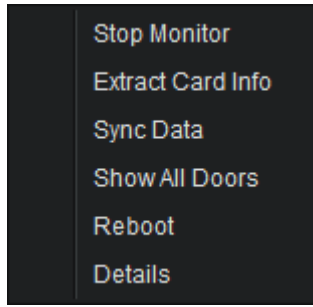

Figure 16-2

Parameter	Note
Monitor	Real-time get device event info.
Details`	Device details search, including device name, device IP, device type, and etc.
Extract Card Info	Extract device card info and fingerprint info, export.
Sync Data	Delete device info (excluding card record and alarm record), sync data in client to device. Data include right info, antipass back info, inter-lock and etc.
Show All Doors	Info of all channels under access control device.
Reboot Device	Reboot device.

Chart 16-2

16.1.1.2.2 Access Control Channel Control

Right click access control channel, support the following operations, and see Figure 16-3.

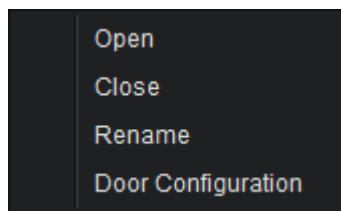

Figure 16-3

Parameter	Note
Open/Close	Remotely open/close door
Rename	Edit channel name
Door Config	Config of door

Chart 16-3

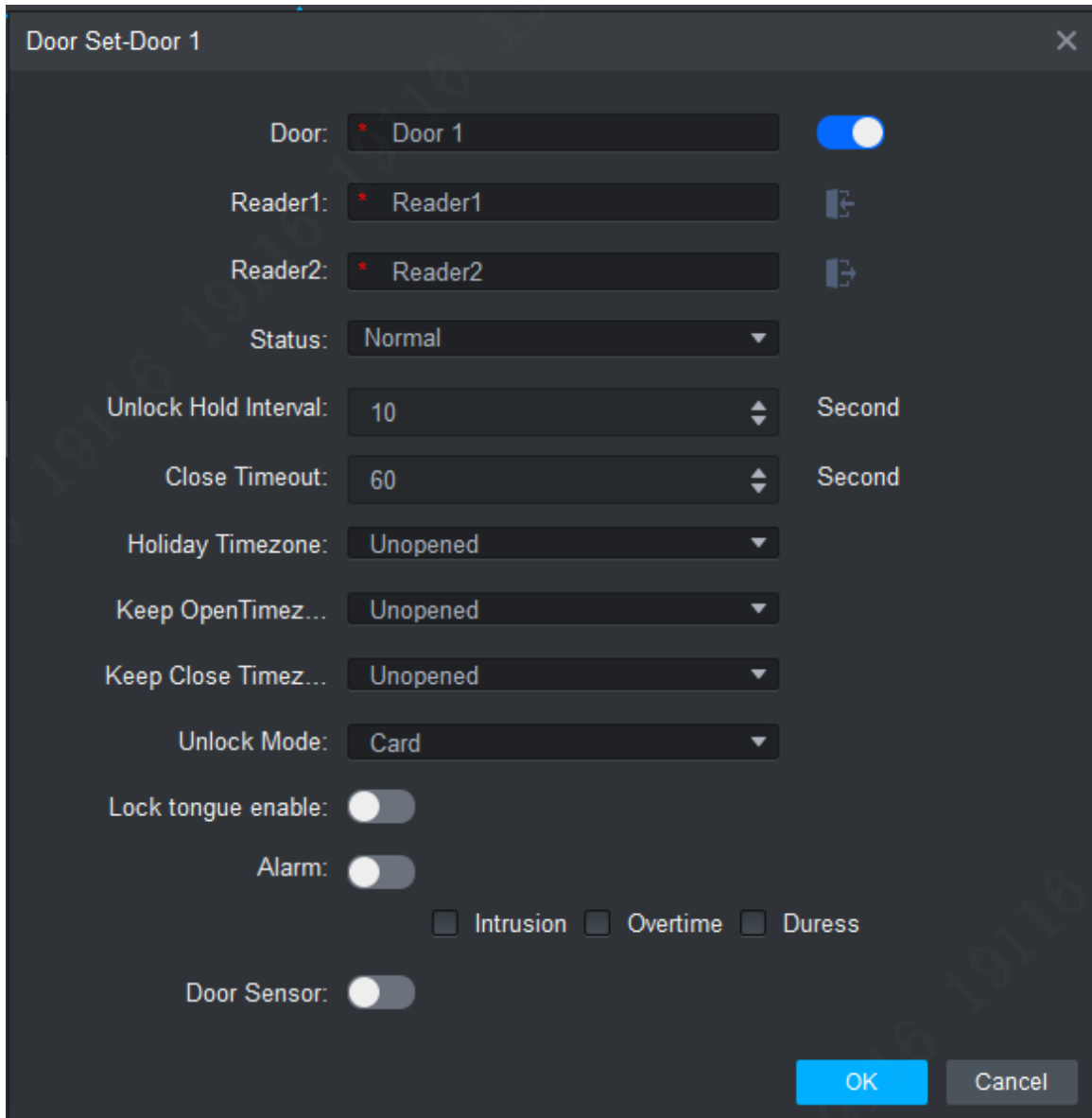



Figure 16-4

Parameter	Note
Door	Customize door name.
Reader X Note: X is a number.	<ol style="list-style-type: none"> 1. Modify reader name. 2. Click  or  to switch in/out status. Name reader and set status, the following is by default: <ul style="list-style-type: none"> ■ Single door one-way: 1 in 2 out. ■ Dual door two-way: 1/3 in, 2/4 out. ■ Four door one-way: 1/2/3/4 in
Status	Normal, NO and NC
Unlock Hold Interval	Unlock hold interval, 1s~600s.
Close Timeout	Door close time out, 1s~9999s.

Parameter	Note
Holiday Time zone	Within access control period, and on holiday, execute holiday period with priority. Default is null.
Keep Open Time zone	Within access control period, and NO period, door is NO. Default is null.
Unlock Mode	You can unlock by card, password, fingerprint, card+password, card+fingerprint, and period. When the door is set to multi-card unlock mode, unlock mode become invalid. By period: Monday~Sunday, 4 periods per day, with period can have different mode.
Lock Tongue Enable	Enable this option, so the system gets tongue status of device.
Alarm	<ul style="list-style-type: none"> • Duress: Force to swipe card and alarm. • Intrusion: Intruded and alarm. • Timeout: door not locked and alarm.
Door Sensor	Door open/close status is judged by actual status.

Chart 16-4

16.1.2 List/View

16.1.2.1 Monitor and Control Access

You can live monitor and control access control in list mode, see Figure 16-5.

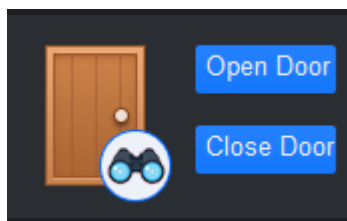

Figure 16-5

16.1.2.2 Live Video/E-map

You can preview video and e-map in view mode, see Figure 16-6.

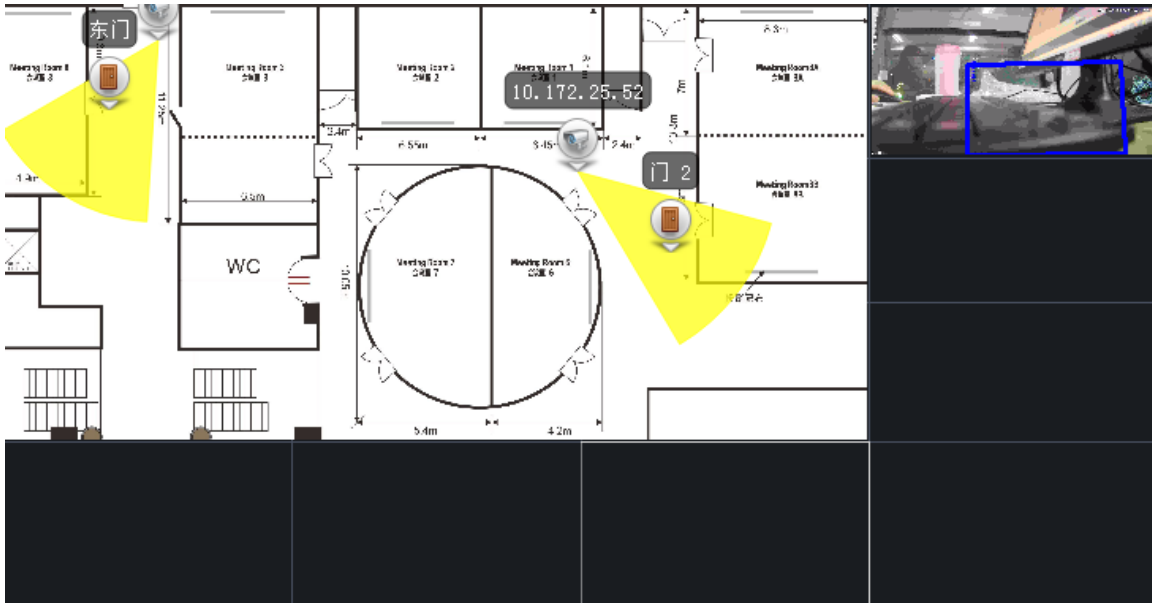

Figure 16-6

- Video preview: please refer to **4.2 Live View**
- E-map preview: After you edit map, you can drag e-map into video window for preview. Scroll your mouse to zoom in/out; click (or move mouse to range within camera) camera icon on map to open video, right click access control on map to enable/disable access.
- Right click in e-map preview window, see Figure 16-7.

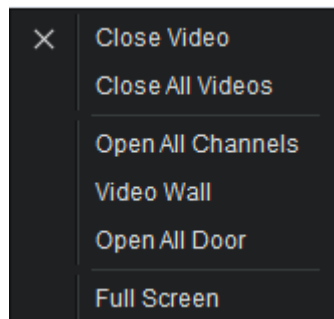







Figure 16-7

Parameter	Note
Close Video	Close current e-map window.
Close All Video	Close all video windows.
Open All Channels	Open all channels on e-map
Video Wall	Output video channel in e-map to video wall.
Open All Doors	Open all accesses on e-map
Full Screen	Display current window in full screen

Chart 16-5

You can click     to switch video format. The first three formats are standard formats in your favorites, click  to split interface, see Figure 16-8.

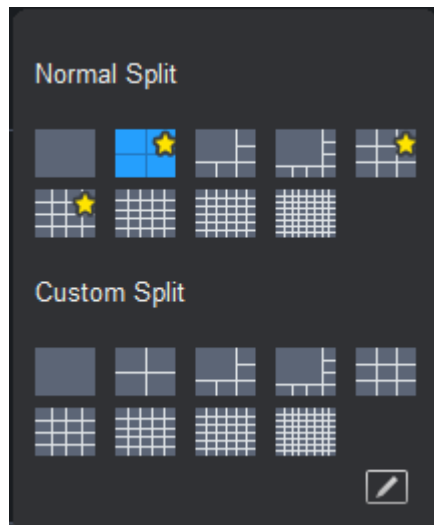

Figure 16-8

You can click add to favorite icon (red heart) to add format into favorites.

Standard split: 1, 4, 6, 8, 9, 16, 25, 36, 64.

Custom split: there are 9 types of custom split, see Figure 16-9.

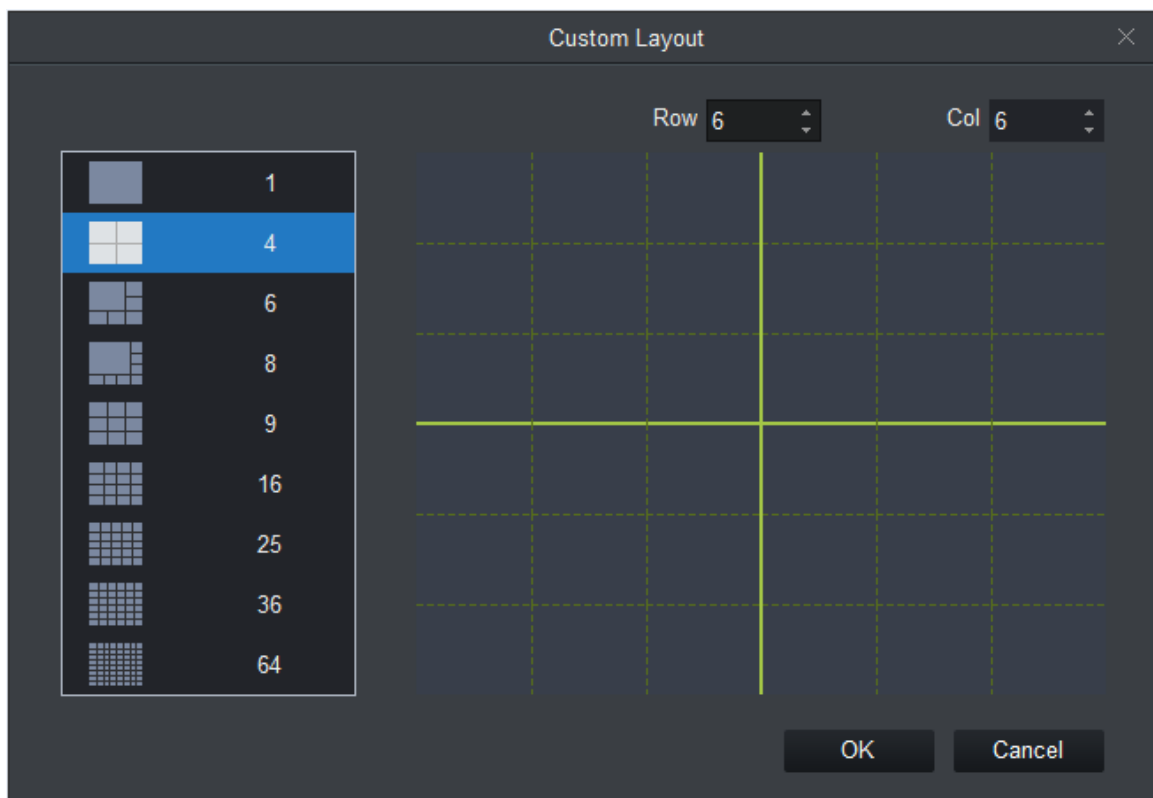

Figure 16-9

16.1.3 Event

Here in event info, you can view all realtime access events and event details of monitored devices, see Figure 16-10. If it is face unlock, then it will display snapshot and face database contrast picture.

Only when access control device is configured with various alarm events, and event notification is enabled on SmartPSS, then event info column will display event records.

You can view all live preview access events and their details of monitored device, see Figure 16-10.

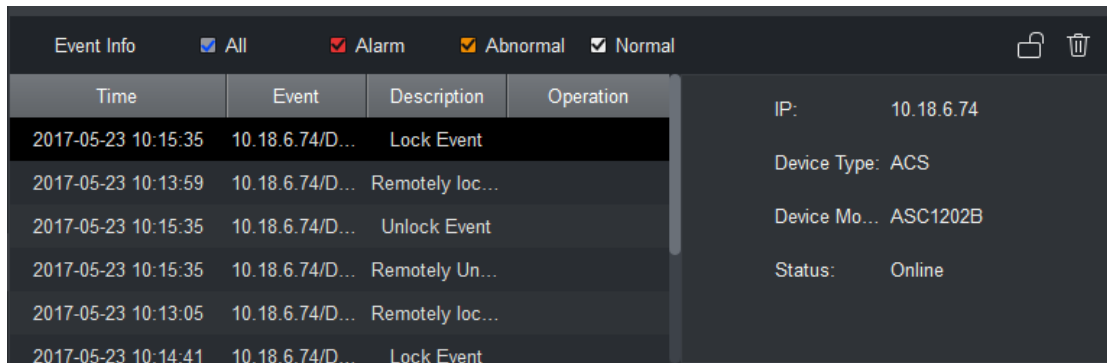

Figure 16-10



Parameter	Note
	Lock event in current event info, during the period the locked event will not be shown in list but user can search for it in log.
	Clear event in current event info, not delete it from log.

Chart 16-6

16.2 User Management

In Access interface, you can click  on the left to enter User Management interface, to manage all users. See Figure 16-11.

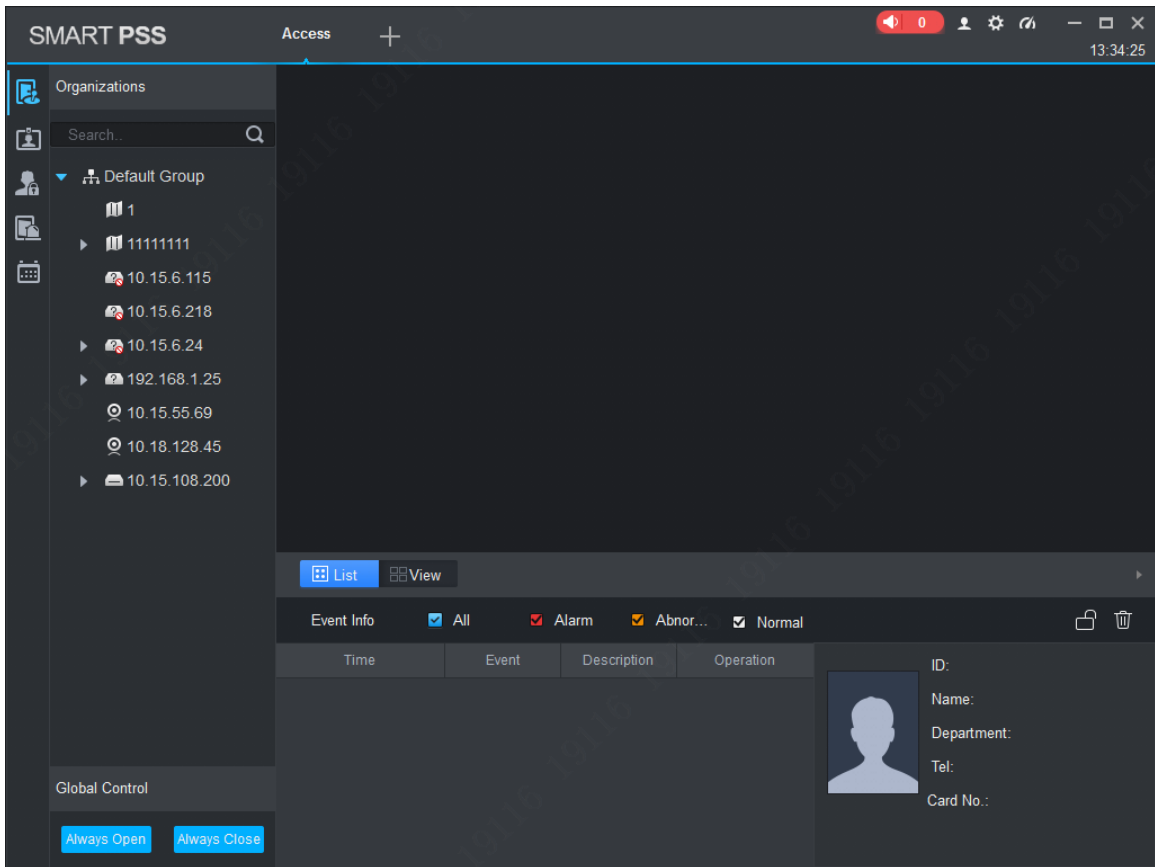

Figure 16-11

No.	Parameter	Note
1	Department Tree	Department management, support to add/delete/edit department organization and people count.
2	User Info	User management, show corresponding user info under department node. Manage user and user card. Sort user by user ID, card no., card type and department.

Chart 16-7

16.2.1 Department Management

At department node or blank area in department tree, you can right click to operate, see Figure 16-12.

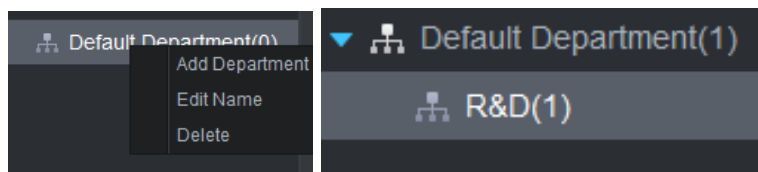

Figure 16-12

Parameter	Note
Add Department	Add department sub node or level 1 department node. Name of departments at same level cannot be repeated.
Edit Department	Edit department name.
Delete Department	Delete existing department. You cannot delete department which contains user.
Search Department	Support search of department node keyword

Chart 16-8

16.2.2 User Management

16.2.2.1 Set Card Type



If card type and card reader do not match, then you cannot read card no.!

Step 1

In User Management interface, you can click  button, select type of card you use, see Figure 16-13.



Figure 16-13

Step 2

Set card type, see Figure 16-4. CPU card supports encryption.

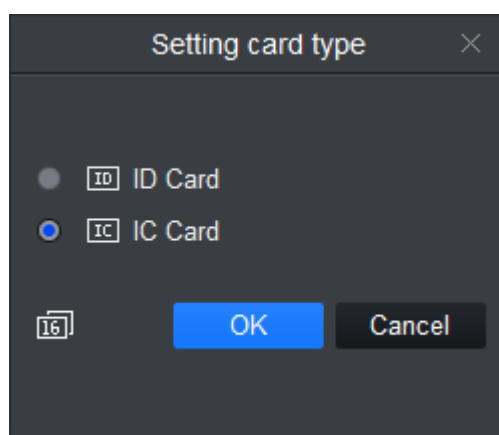

Figure 16-14

16.2.2.2 Add User

16.2.2.2.1 Add Single User

Step 1

On **User Management** interface, select department on the device tree and click.

The system will display the interface of Add User. See Figure 17-16.

The screenshot shows the 'Add User' window with three tabs: 'Basic Info', 'Fingerprint Info', and 'Details'. The 'Basic Info' tab is active. Fields include:

- User ID: * (mandatory)
- Name: * (mandatory)
- Department: Default Department (dropdown)
- Card No.: Card Reader not ready! (text) | Card issuer (dropdown)
- Card Type: General Card (dropdown)
- Card Password: (text)
- Unlock Password: (text)
- Number of Use: 200 (text)
- Valid Time: 2017/5/23 0:00:00 (start) | 2027/5/23 23:59:59 (end) | 3653 Days
- Image upload section: Image Size: 0 ~ 120KB, Upload Picture button

 A note at the bottom states: 'Make sure reader and card are in agreement.' Buttons at the bottom are 'Continue to Add', 'Finish', and 'Cancel'.

Figure 16-15

Step 2

Click Basic Info and configure personnel basic info.

Parameter	Note
Basic Info	<p>User ID 【mandatory】</p> <p>Name 【mandatory】</p> <p>Department 【Auto】</p> <p>Card no.: input by card reader and manually</p> <p>Card type: general card, VIP card, guest card, blacklist card, patrol card, and duress card</p> <p>Unlock password: only used for unlock via password</p> <p>Card password: used for card+password unlock</p> <p>Number of use: only for guest card</p> <p>Validity: card validity, 10 years by default</p> <p>Picture: user photo, max 120K</p> <p>Note:</p> <p>Card no. and user ID cannot be repeated.</p>

Parameter	Note
Fingerprint Info	Collect fingerprint via fingerprint device and reader Each user can have up to 3 fingerprints Support input of fingerprint name
Details	Gender, title, education and etc.

Chart 16-9

Step 3

Click Fingerprint Info, select fingerprint device and then input fingerprint info according to interface tips. See Figure 16-6.

Supports max 3 fingerprints for everyone, besides, it also supports fingerprint name.

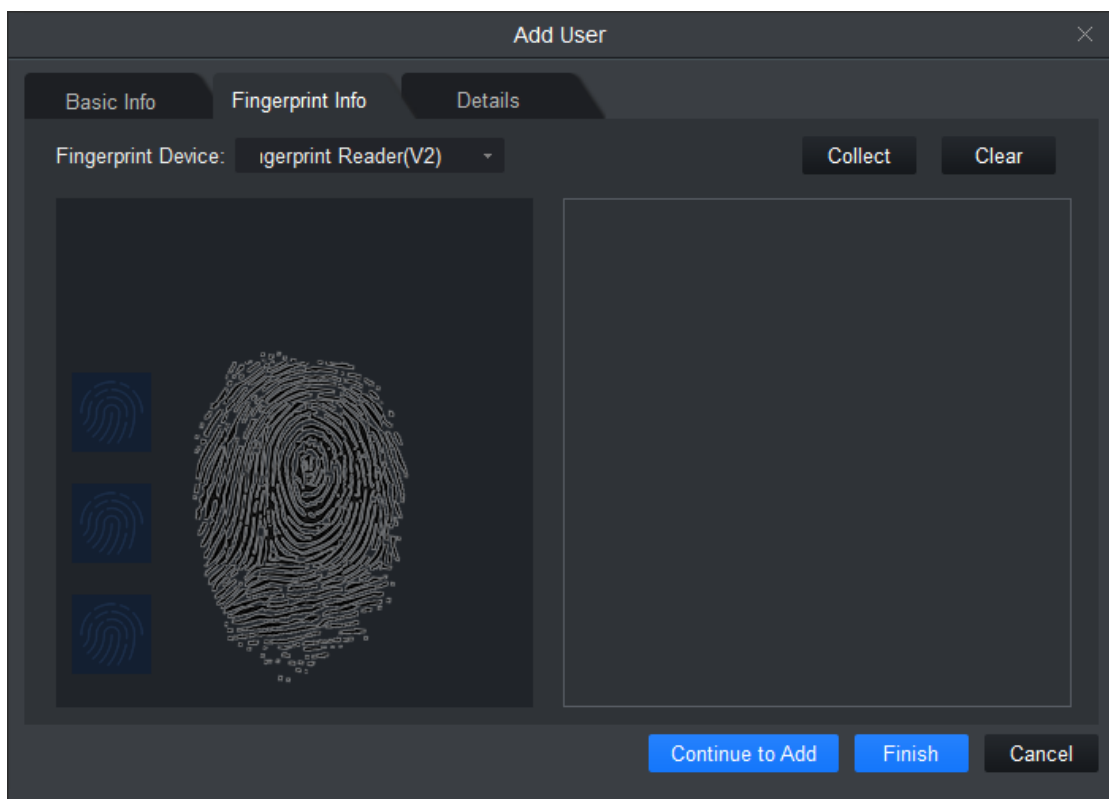

Figure 16-16

Step 4

Configure details for personnel, see Figure 16-17.

Figure 16-17

Step 5

Click Finish and save config.

16.2.2.2.2 Batch Add

In User Management interface, you can click  button to batch issue card, see Figure 16-18.

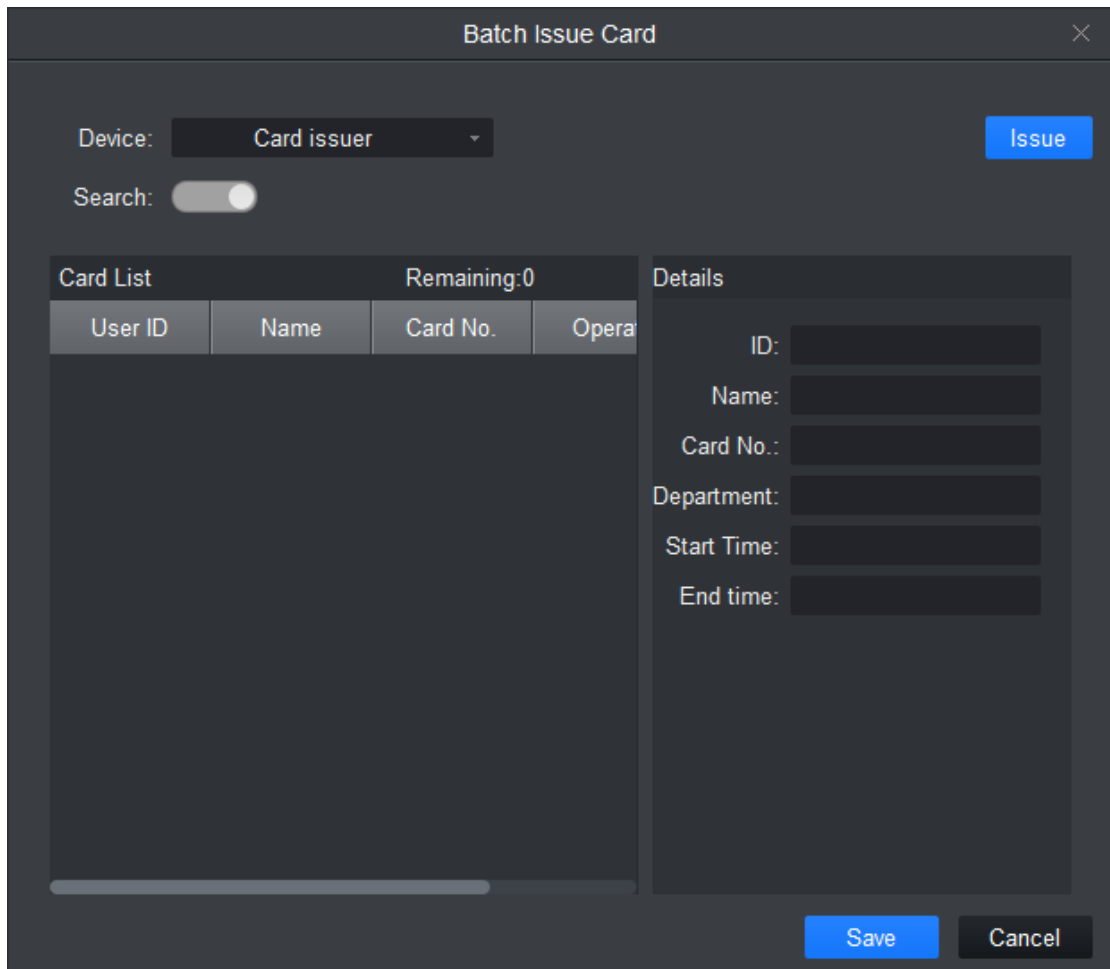

Figure 16-18

Parameter	Note
Batch Issue Card by User	<p>Manually check user to want to issue card to 【auto filter out users already have card】</p> <p>Click Batch</p> <p>User select card issuing device: support card issuer and card reader of controller.</p> <p>Click read card no, and device starts to read.</p> <p>Place card on device, link user to card no. one by one.</p> <p>Click Save to complete card issuing.</p>

Parameter	Note
Batch Issue Card by User ID/Name	<p>User click to batch issue card</p> <p>Enable <input type="checkbox"/> Work ID: <input checked="" type="checkbox"/></p> <p>User can enter user ID or name to fuzzy search.</p> <p>Click to get user and auto complete adding user or directly click search to get first 200 unauthorized users. .</p> <p>Click read card no., so device starts to read card no.</p> <p>Place card on device one by one to link card to work ID by sequence.</p> <p>Click Save to complete.</p>

Chart 16-10

In User Management, you can click  button to edit user, see Figure 16-19.

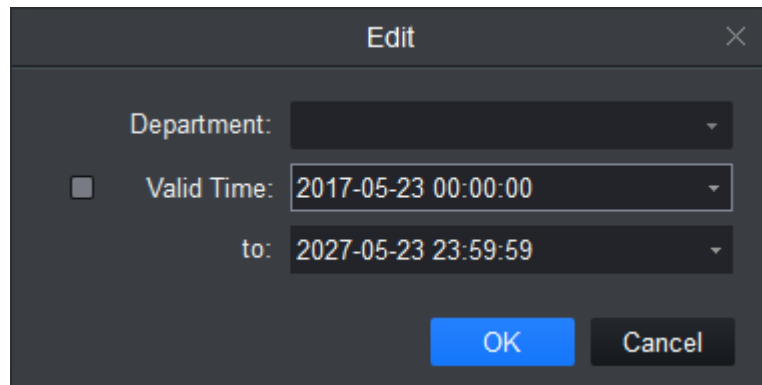



Figure 16-19

Parameter	Note
Department	<p>Check user you want to edit.</p> <p>Click .</p> <p>Select new department.</p> <p>Click OK.</p> <p>Complete.</p>



Parameter	Note
Validity	<p>Check user you want to edit.</p> <p>Click .</p> <p>Check valid time.</p> <p>Set time.</p> <p>Modified valid time will be sent to device.</p> <p>Complete.</p>

Chart 16-11

16.2.2.2.3 Delete

In User Management interface, click  button to delete user. Check user you want to delete, click Delete. Confirm that all information and rights of the user you are doing to delete will be deleted from the device.

16.2.2.2.4 Import/Export



If imported data (User ID/card no.) already exists, it will not import the information.

You can click either of  or  to import/export user info.

Import/export info includes: user ID, name, card no., card type, department, fingerprint name, fingerprint name.



During data importing, it auto generates department.

16.2.2.2.5 More Operations

In User Management interface, you can click .





Parameter	Note
	Modify user info.
	Delete user info.
	Clear user card no. and delete card info in device.
	Freeze card no. in device. You can click unfreeze if you want to restore frozen card.

Chart 16-12

In User Management interface, you can click  to search keyword of user.

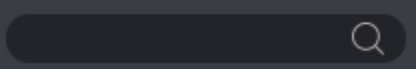

- User ID and name support fuzzy search.
- Card no. supports accurate search.

16.2.2.2.6 Batch Import

Supports importing personnel info including picture to system by template.



- Please make sure the personnel info template exists before batch import. Please click  to acquire template on the interface of Personnel Management.
- If import data (Card No. /Employee No.) already exists, then it doesn't have to be imported.
- Data can be automatically generated for department.

Click , select template and import personnel info. See Figure 16-20.

Picture path is set as face picture storage path. It only needs to fill in picture file name if both picture and personnel list excel file are in the same folder.

User ID	Name	Card No.	Card Type	Department	Finger Name 1	Finger Property 1	Finger Name 2	Finger Property 2	Finger Name 3	Finger Property 3	Pic Path
121654	EDW		General Card	Default Department:R&D							

Figure 16-20

16.2.2.3 Edit Personnel

Modify personnel info, including issuing card, inputting fingerprint and registering details.

Step 1

On Personnel Management interface, input fingerprint info and register details.

Step 2

Click  and the interface of Edit Personnel is displayed. See Figure 16-21.

Figure 16-21

Step 3

Edit personnel info.

Step 4

Click Finish.

16.2.2.4 Delete Personnel

After personnel are deleted, it will clear all the personnel info and permission of the client.

Single Delete

Click  next to the person and delete according to interface prompt.

Batch Delete

Select the persons you want to delete, click  and operate according to the interface prompt.

16.2.2.5 Export Personnel Info

Export personnel info and save it locally.

Click  and select personnel info template storage path, export personnel info. Import/Export files.

16.2.2.6 Issue Card

Issue access control cards for people in batches.

Step 1

On the interface of Personnel Management, select department on the device tree and click .

The interface of Batch Issue Card is displayed. See Figure 17-24.

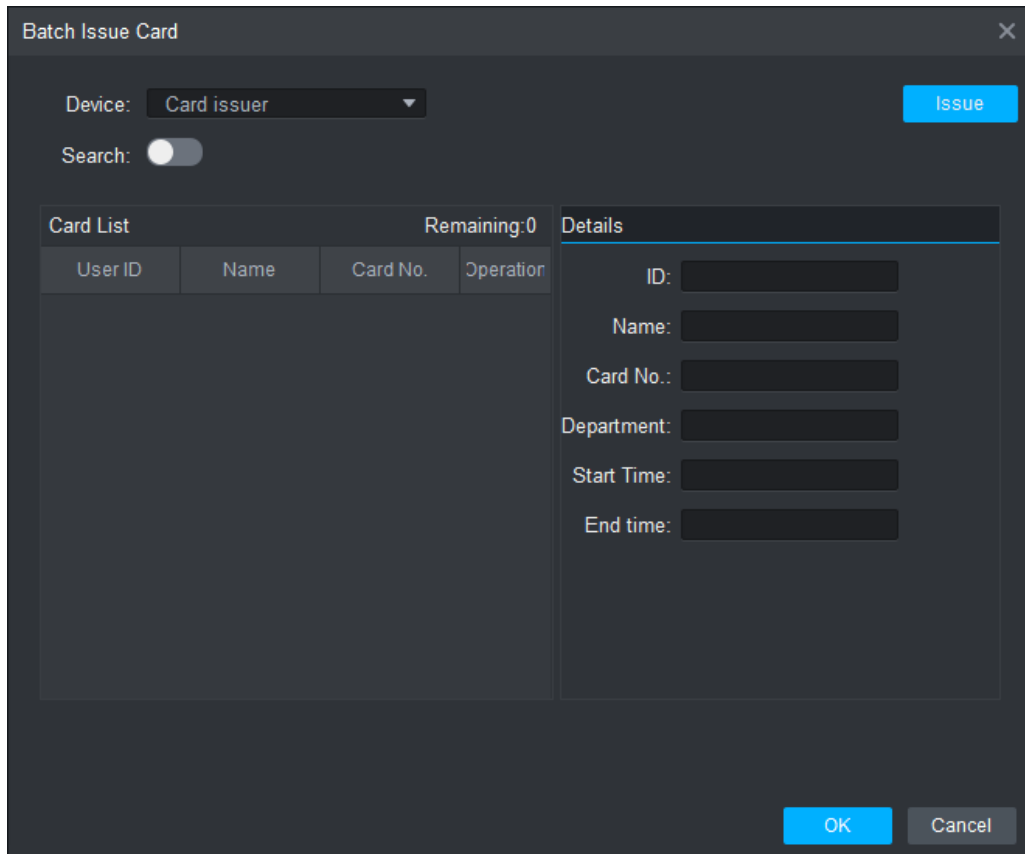



Figure 16-22

Step 2

Click  and enable search function.

  Means that the function is enabled.

Step 3

Click Acquire Personnel

It will display people to be issued card in the **Personnel List** area.



- The system filters issued cards automatically.
- If you need to search people accurately, input person number or name and click Acquire Personnel.

Step 4

Select device, including card reader or device (access control device), please continue to select reading head if you select device.

Step 5



Click Read Card No. and put the card on the device successively, which associating people with card number.

Step 6

Click OK and save.



16.2.2.7 Freeze Card

After the access control card is frozen, then it cannot be used any more.

On the interface of Personnel Management, click  in the personnel list, freeze card according to system prompt. The icon is shown as  after the card is frozen.



16.2.2.8 Unfreeze Card

The access card is equipped with unlock permission after it is unfrozen.

On Personnel Management interface, click  and unfreeze card according to system prompt. The icon is shown as  after it is unfrozen.

16.2.2.9 Card Loss Report

Please report for loss when the access card cannot be used anymore, then you can delete all the permissions of the person.

On Personnel Management interface, click  and report for loss according to system prompt. The icon is shown as  after is reported for loss.

16.3 Permission Management

In Access interface, you can click  on the left to enter Permission Management which allows management of right about user issuing card.

16.3.1 Period Setup

In Permission Management interface, click Period Setup to set specific reader to be valid with specific period and not valid on other periods, as well as set that user can only access a specific door within a specific period. Period is used for NO period, holiday period, first card period, remote verification period, door group right period.

16.3.1.1 Normal Period

Step 1

Click , select Period Setup.

Step 2

Click Add, see Figure 16-23.

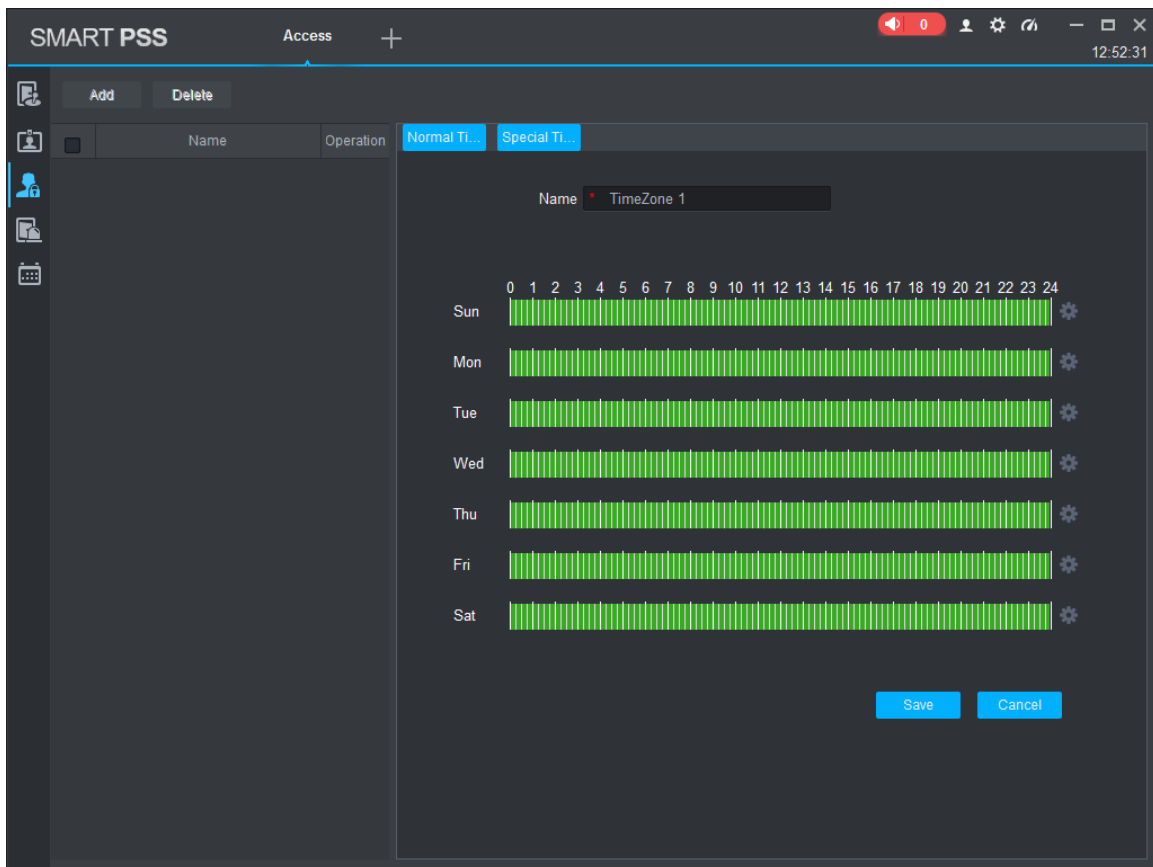

Figure 16-23

Step 3

Enter period name.

Step 4

Select daily period for Monday to Sunday.



A device supports to 128 periods setup with daily limit of 4 periods.

16.3.2 Holiday Setup

In Permission Setup interface, click Holiday Setup to set different access period from general period.

Step 1

Click , select Holiday Setup.

Step 2

Click Add, see Figure 16-24.

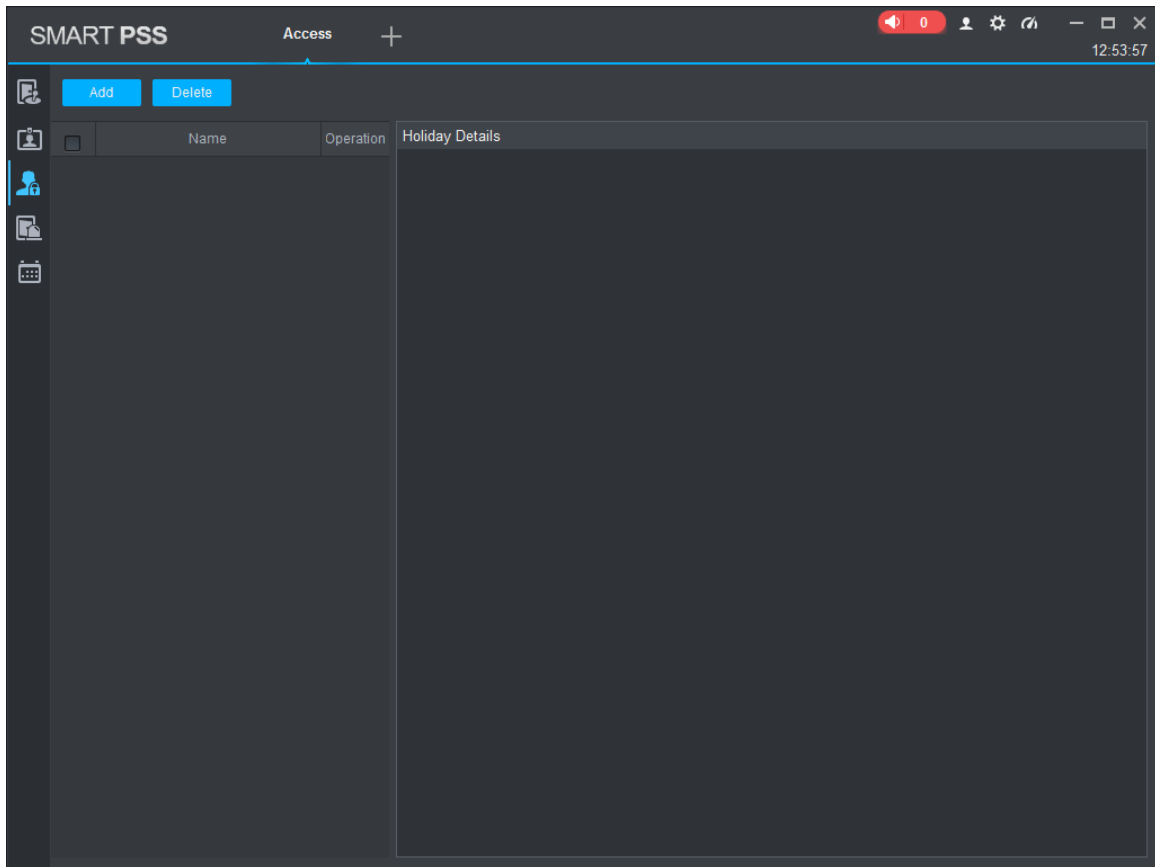

Figure 16-24

Step 3

Enter name.

Step 4

Select range.



Within holiday period, holiday has priority in execution. Holiday period is for access only.

16.3.3 Holiday Management

Set holiday time, the access time of holiday period may be different from normal access time, to make it simple; the system provides holiday management where you can set access time for holidays.

Step 1



Click  and select **Holiday Management**. The system displays the interface of **Holiday Management**.

Step 2

Click Add. The interface of Holiday Details is displayed. See Figure 16-25.

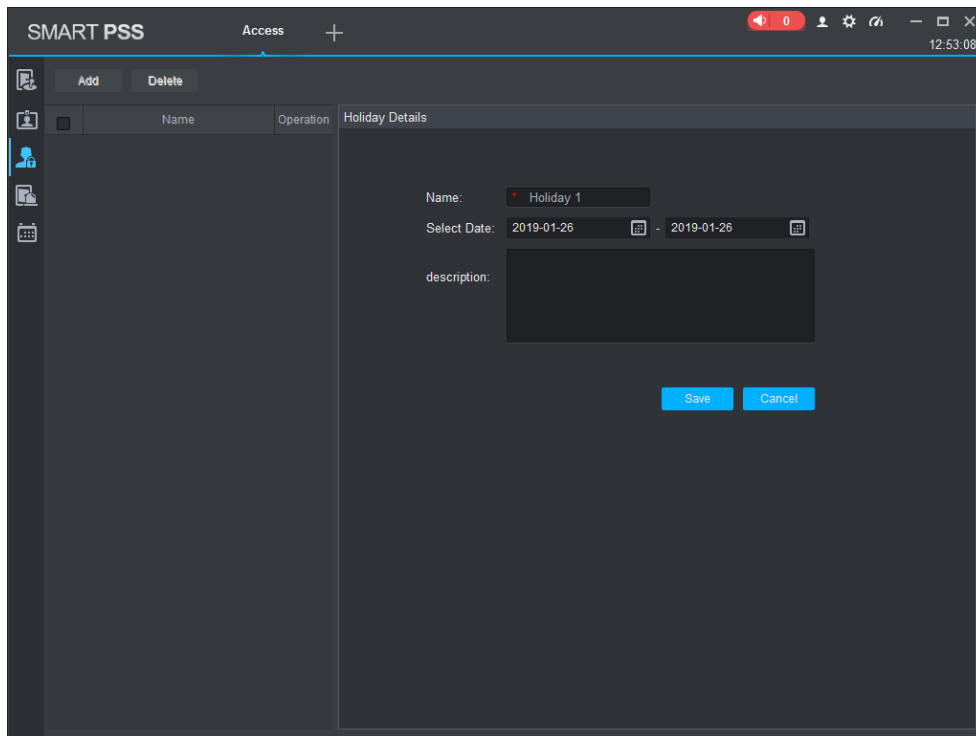

Figure 16-25

Step 3

Input holiday name.

Step 4

Select date.

Step 5

Click Save.



With holiday date, holiday period is implemented by priority; holiday period can only be used for access period.

16.3.4 Door Group Right



In User Management interface, you can click , and set a specific period of time, a specific door or door group can be unlocked via verification, see Figure 16-26.

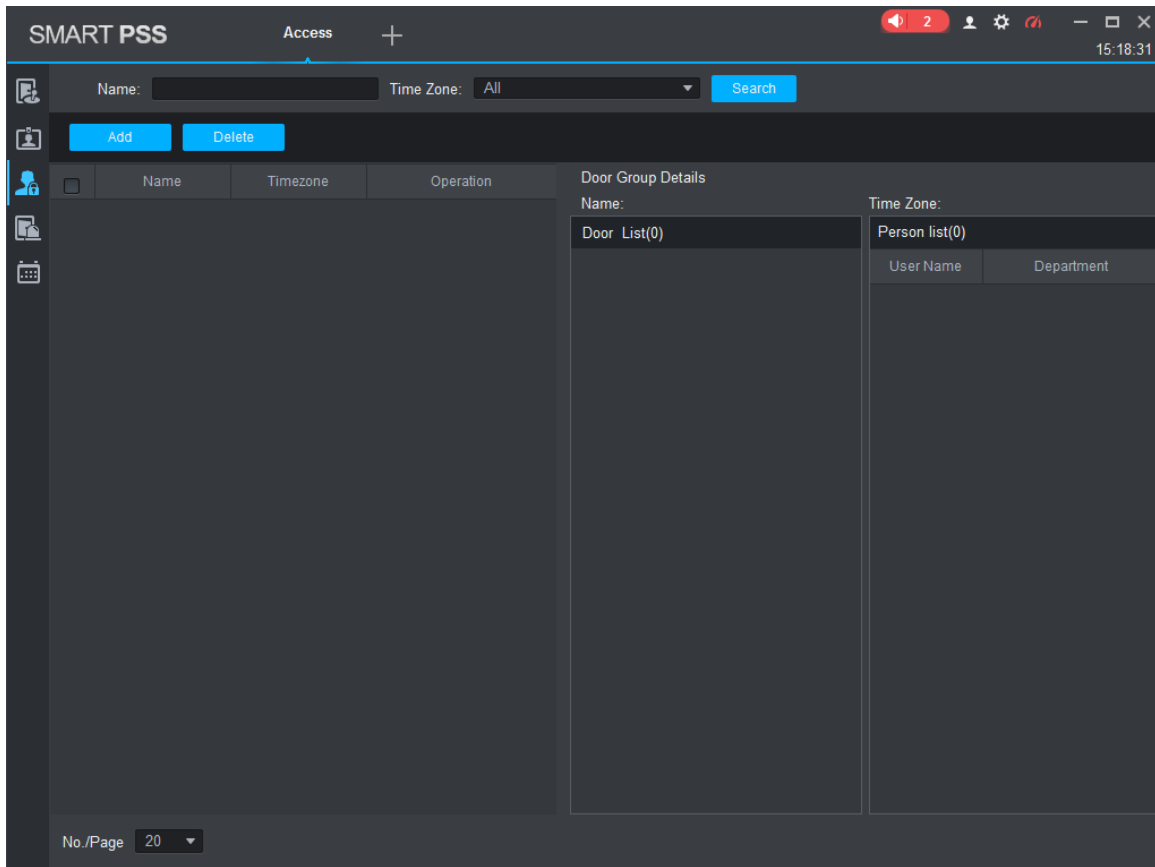

Figure 16-26

No.	Parameter	Note
1	Door Group Info	Client door group info list
2	Door Group Details	Details of current door group
3	User Info	User right info of current door group

Chart 16-13

16.3.4.1 Add Door Group

Door group info cannot be repeated.

Step 1

Click Add on the interface of **Door Group Permission**, the system will display the interface of **Add Door Group**. See Figure 16-27.

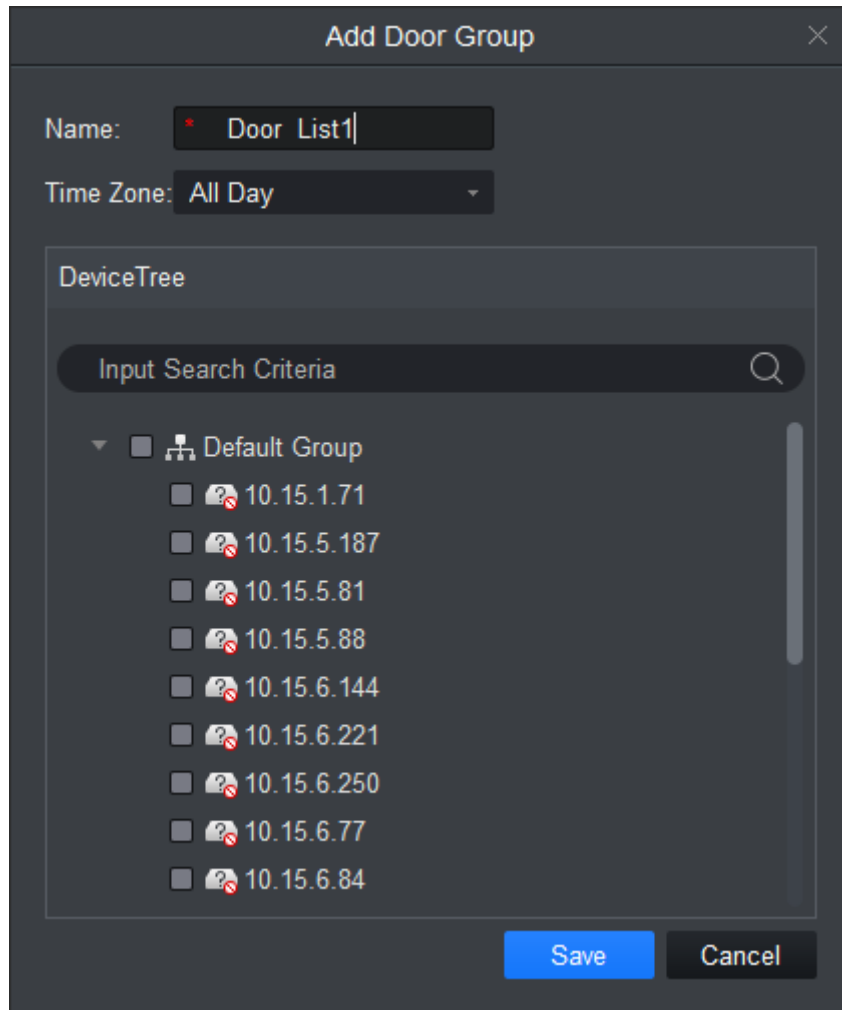

Figure 16-27

Step 2

Enter name of door group, which cannot repeat existing door group name.

Step 3

Select access period.

Step 4

Check door, click Save.

16.3.4.2 Modify Door Group Info

You can click on the interface of Door Group Permission, and then modify door group info.

16.3.4.3 Add Personnel Permission

Step 1

Click on the interface of Door Group Permission, and then you can add personnel permission for door group.

The interface of User Select is displayed. See Figure 16-28.

Step 2

Click  button to re-edit door group info.



Door group name cannot be repeated.

In Door Group Right interface, click  to add use right, see Figure 16-28

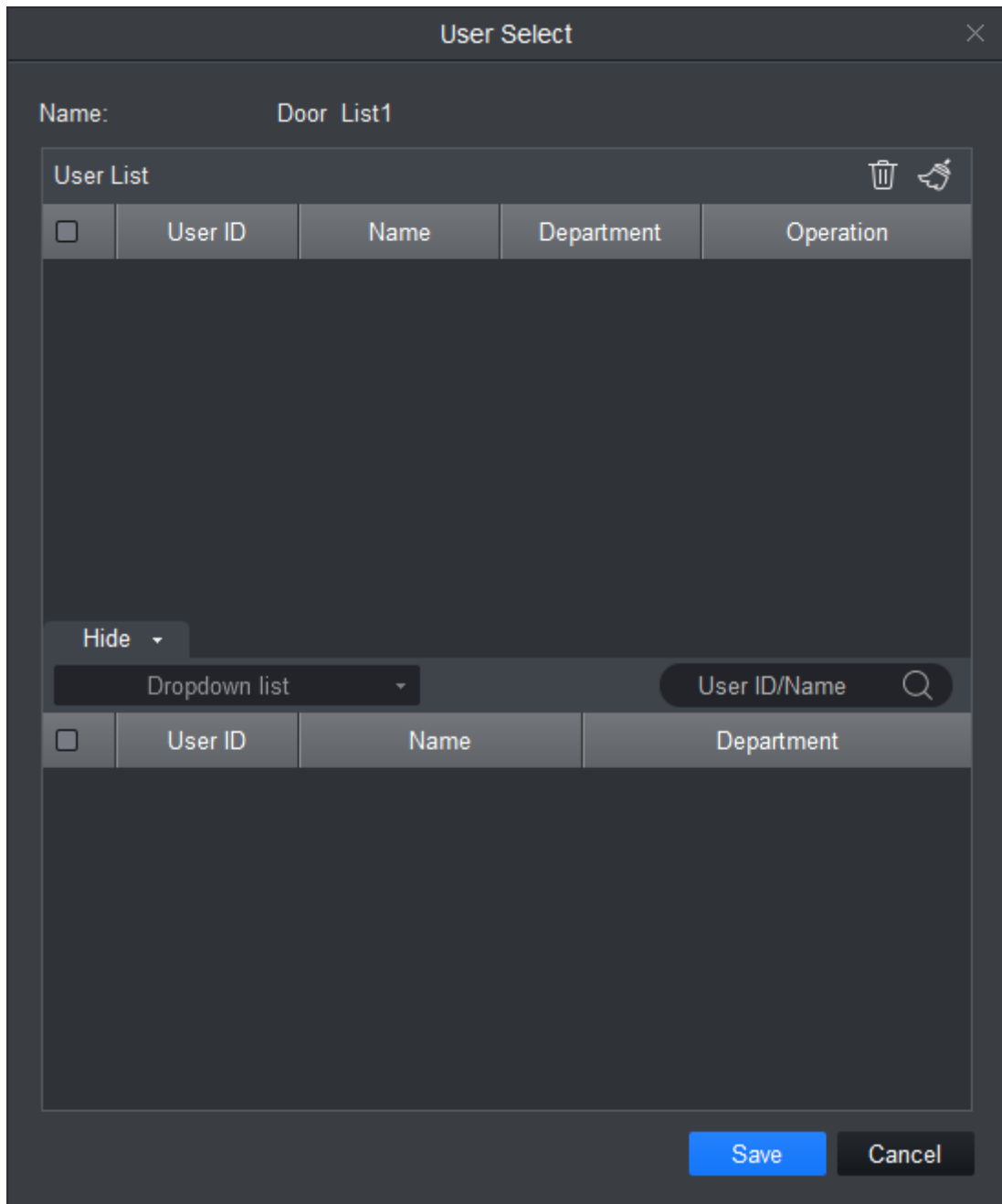

Figure 16-28

No.	Parameter	Note
1	User List	Existing user info with door group right
2	Search List	Info of user without door group right

Chart 16-14

Step 3

In search list dropdown list, select department of user you want to add or directly enter user ID or name.

Step 4

In search list check searched user and add to list.

Step 5

You can delete user who already has right.



Step 6

Click Save, to complete the selected user into all door groups.



In search list filter out user who do not have card no. info.

16.3.4.4 Delete Info

- Select people from Personnel List on the interface of Door Group Permission, click  and delete the selected personnel and device permission.
- Select people from Personnel List on the interface of Door Group Permission, click  and delete the corresponding personnel and device permission.
- Click  on the interface of Door Group Permission, the system will delete all the people of the door group and delete device permission.

In Door Group Right interface, you can click  button to delete all information and right of the door group in the system.



During right issuing process, please sure client and device are well connected.

16.3.5 User Right

In User Management interface, you can click  in User Right interface to add specific user into access right list, or delete specific user from list.



Please make sure the client is normally connected to device when issuing permission.

Step 1

Check or cancel checked door group.

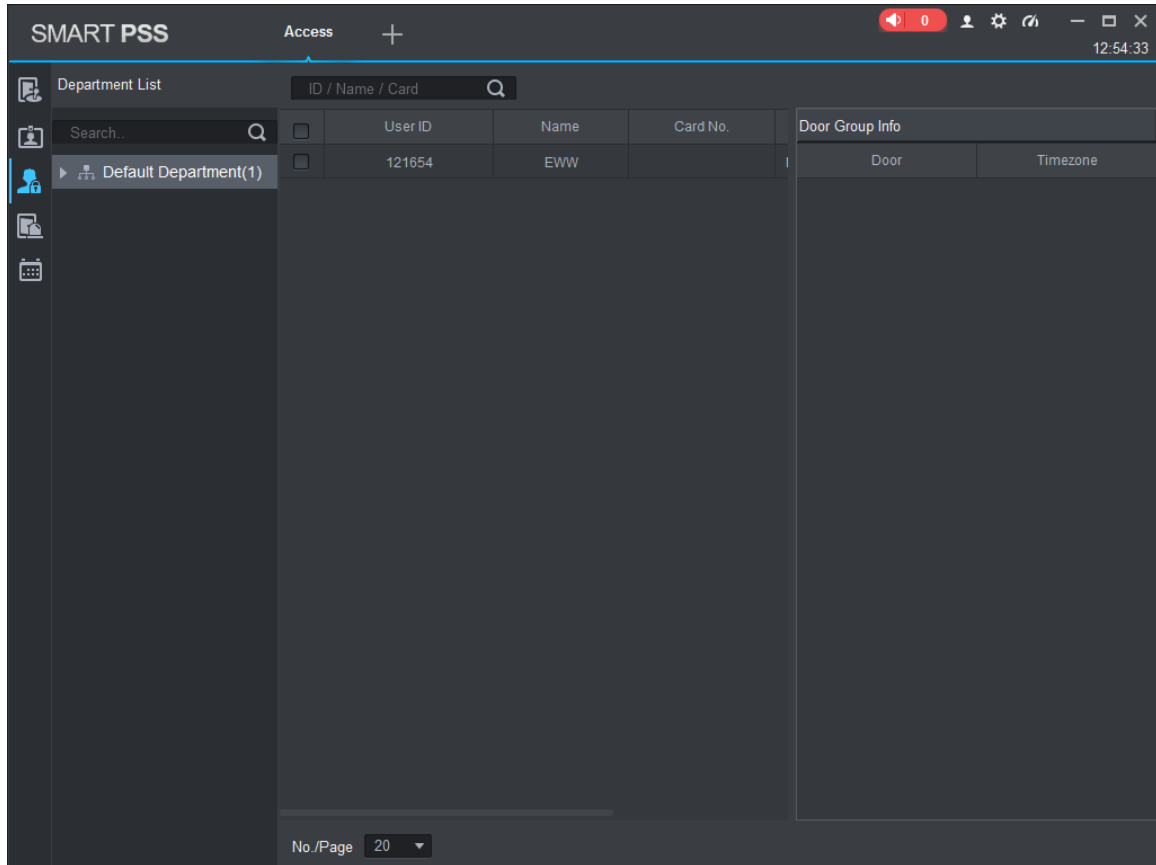

Figure 16-29

Step 2

Click OK as to confirm cancellation or adding of personal user right.

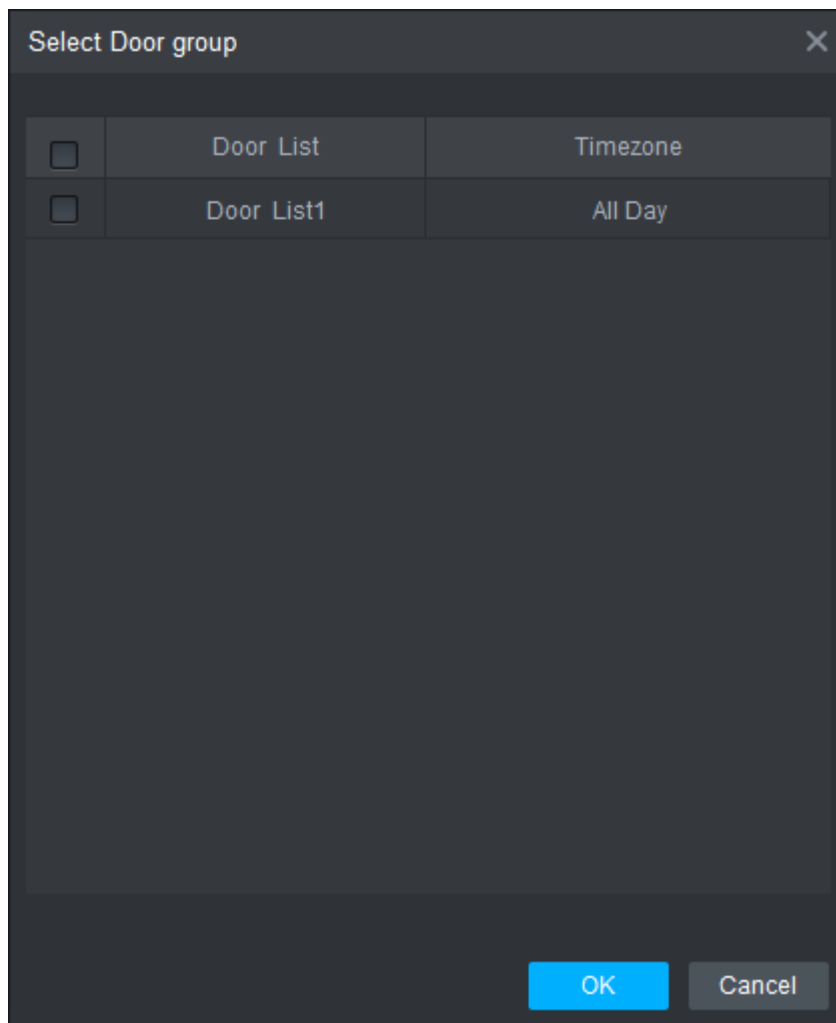

Figure 16-30

Step 3

Select or not select door group.

Step 4

Click OK and you can add or cancel person permission.

16.3.6 First Card Unlock

After you set first card unlock function, when everyday you are first user swipe card, you must pass that verification before you can unlock at access.

Step 1

Click , select First Card Unlock, see Figure 16-31.

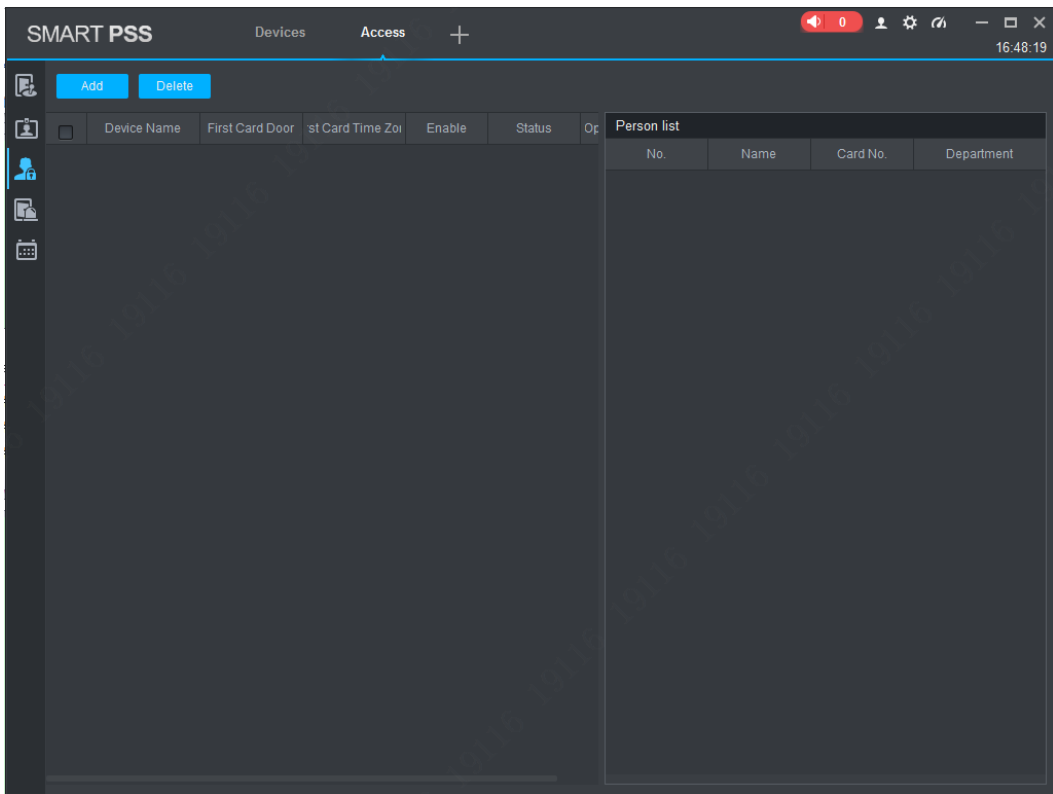

Figure 16-31

Step 2

Click Add, see Figure 16-32.

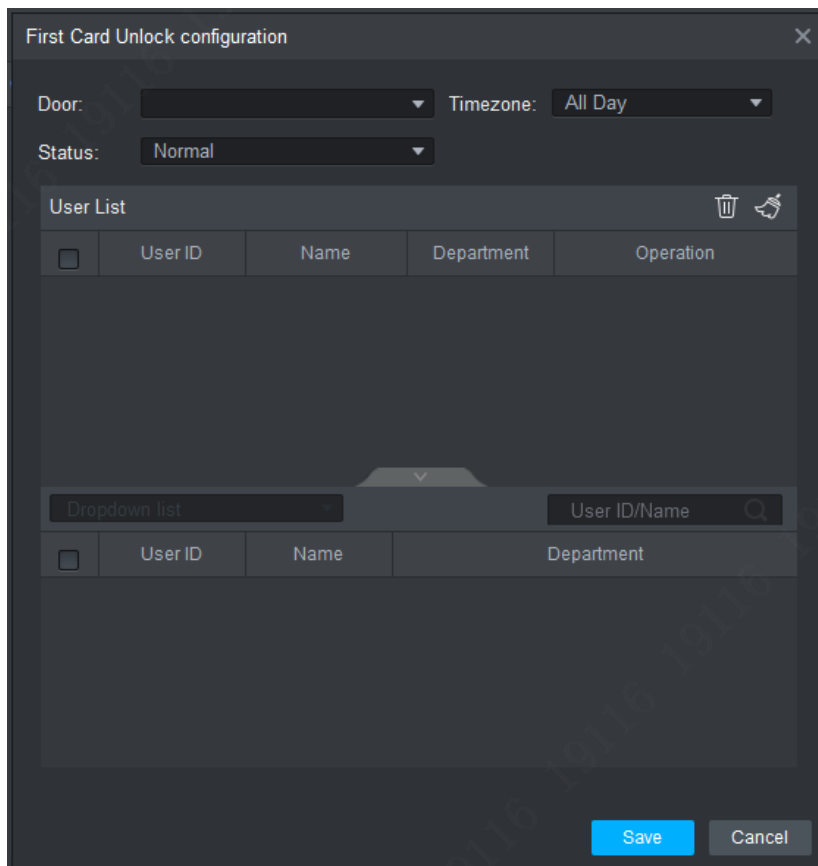

Figure 16-32

Step 3

Select door, period, and status of first card. Status means status after you swipe card.

Step 4

In search list, search user by department, no. or name.

Step 5

Check user.

Step 6

Click Save.



For user who is auto filtered out in search list due to lack of right of the door, he/she must be given right of this door by first card right holder.

16.3.7 Multi-card Unlock

You can click Multi-door Lock to set that a specific door can be unlocked only when specific users of a group all pass verification in a specific order.



- Supports max 64 people for one group.
- Multi-door unlock supports 4 groups of people on-site verification at the same time, total 64 people, valid people up to 5.

Step 1



Click , select Multi-door Lock.

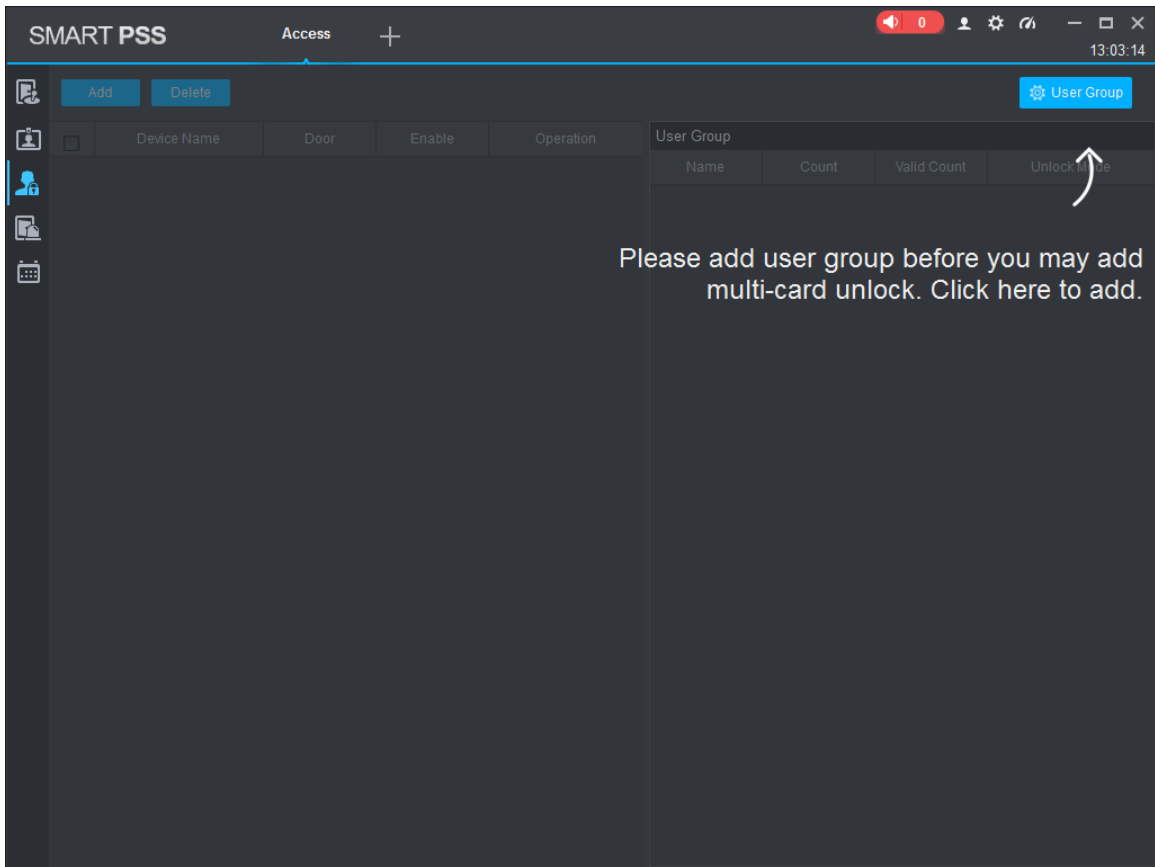

Figure 16-33

Step 2

Manage personnel group.

It needs to add personnel group before adding multi-card unlock.

1. Click User Group Manager.

The system will display the interface. See Figure 16-34.

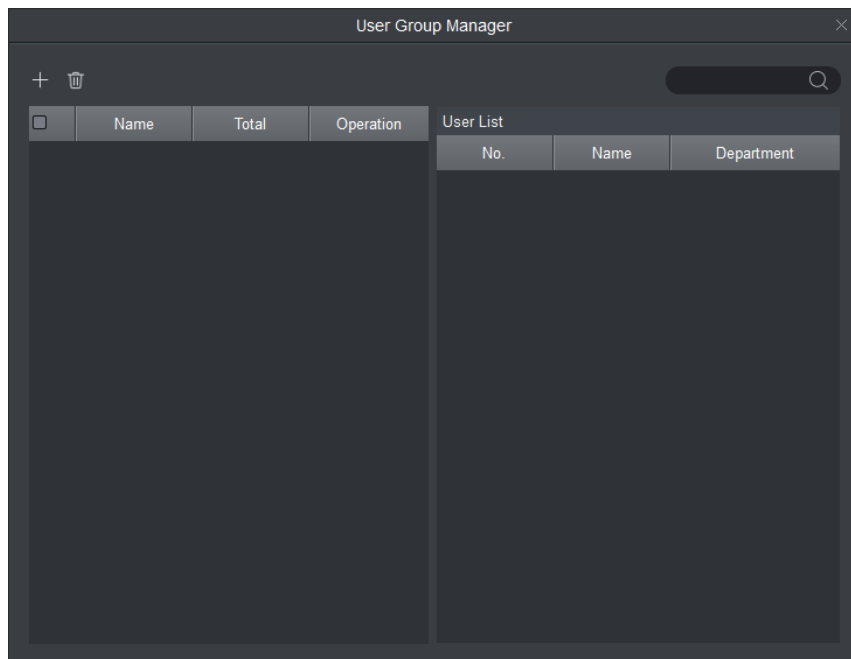

Figure 16-34

2. Click  and system displays the interface of User Group Edit. See Figure 16-35.

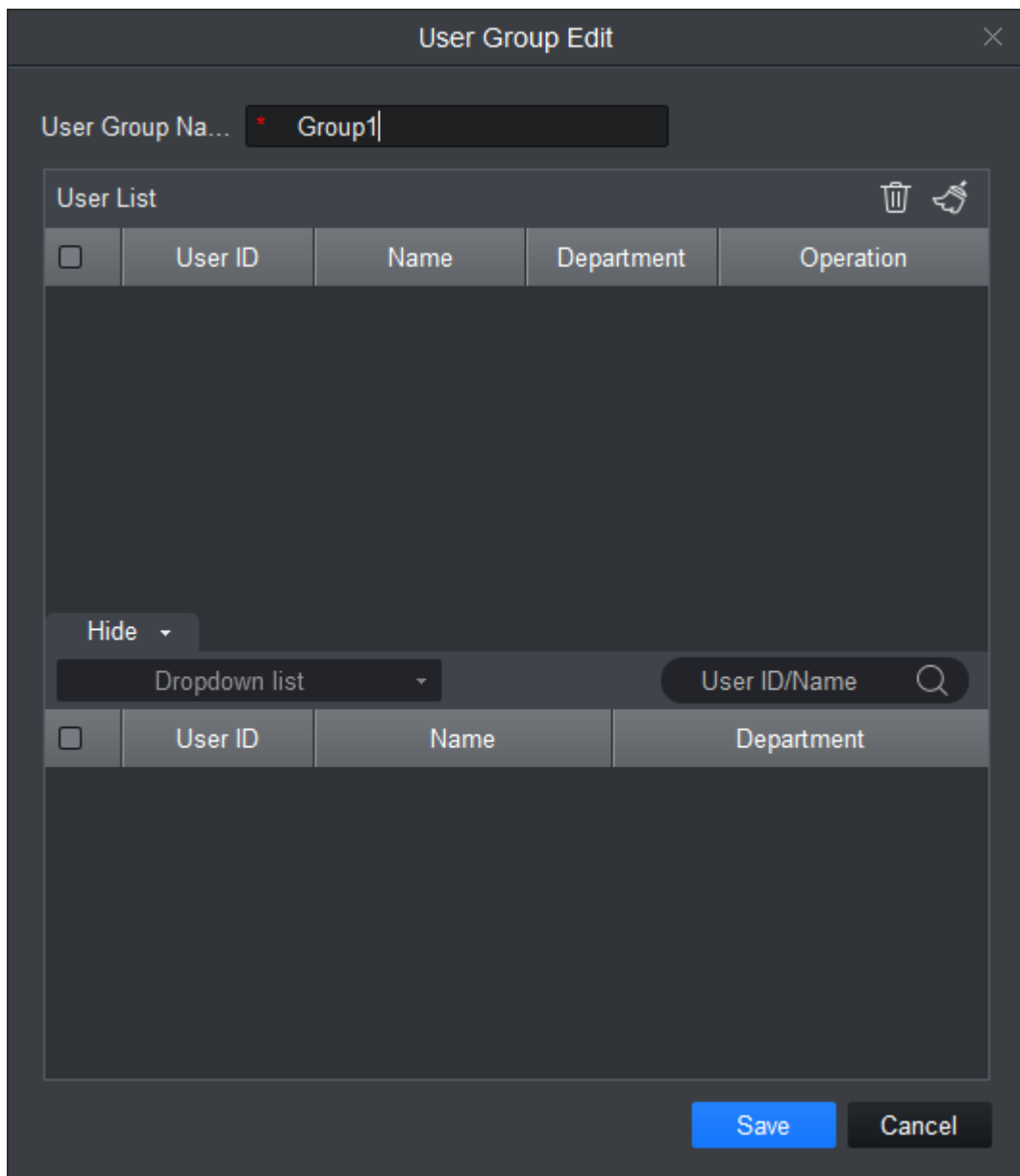



Figure 16-35

3. Search personnel by department, number or name.
4. Select personnel.
5. Click Save.
6. Click  and close the interface of User Group Edit.

Step 3

Set multi-card unlock.

1. Click Add on the interface of Multi-card Unlock.
The system displays the interface, see Figure 16-36.

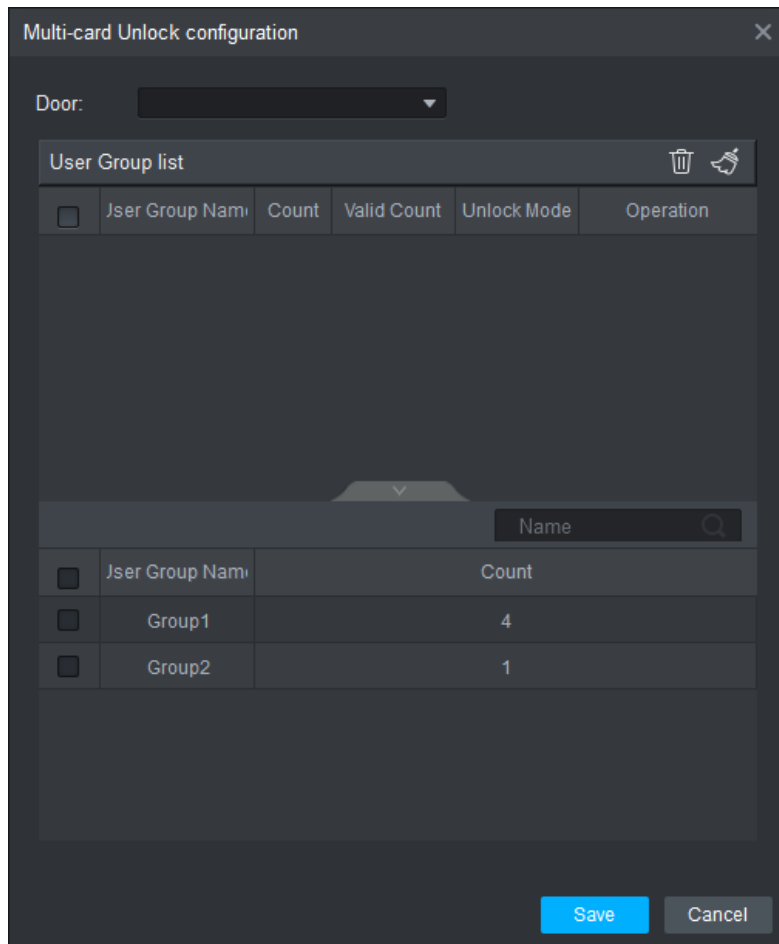



Figure 16-36

2. Set multi-card unlock, see

Select the door which enables multi-card unlock; select designated personnel group; fill in present valid people number of each group and unlock mode, click  or  to adjust the unlock sequence of each group. See Figure 16-37.

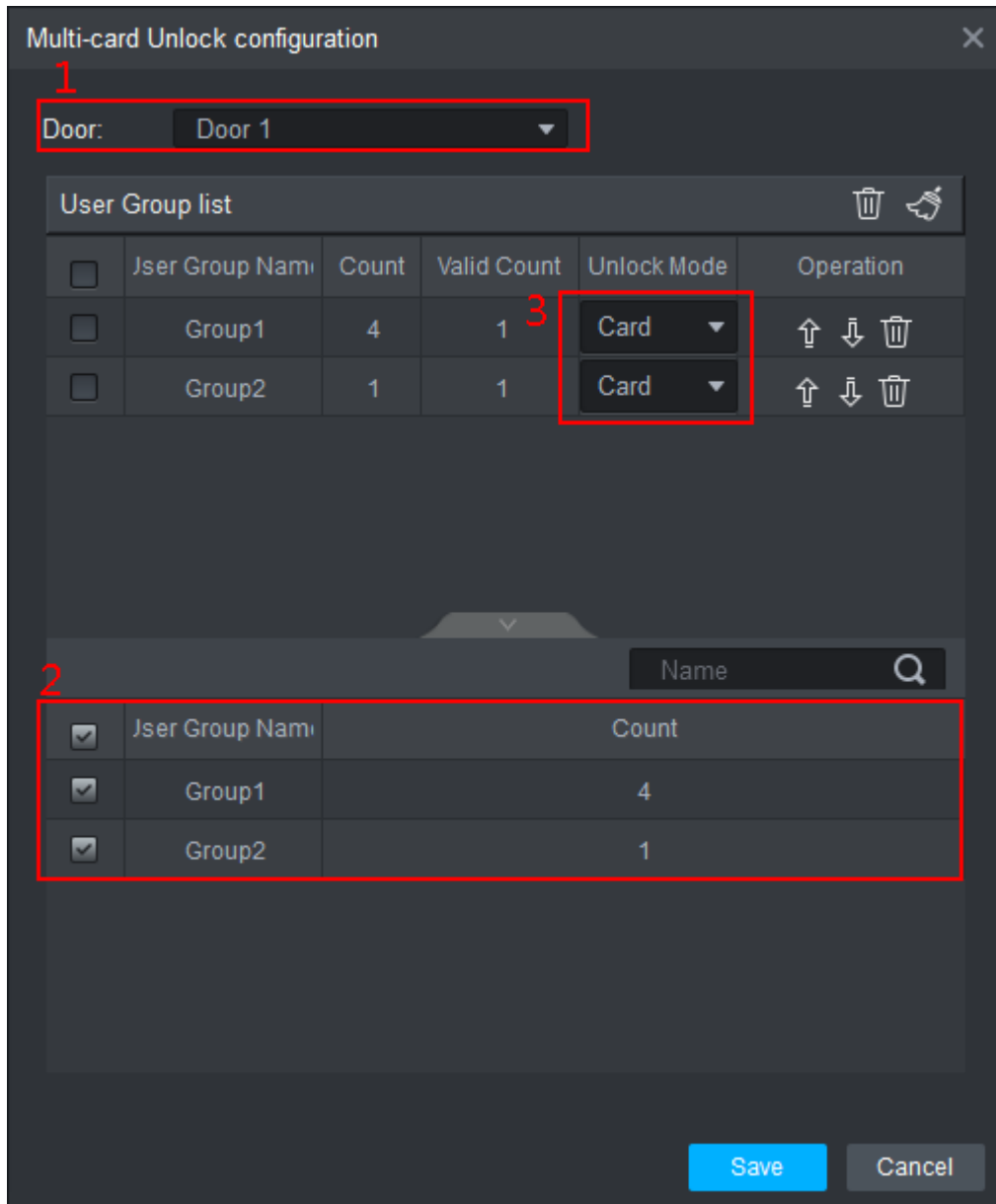

Figure 16-37

3. Click Save.

16.3.8 Anti-pass Back

In Permission Management interface, click Anti-pass Back to set verification user. A user verifies at door A must verify at door A again when exits since card record must match one to one. If a user does not verify when enters, he/she will not pass verification when exits.

Step 1

Click , select **Anti-pass Back**.

The interface of Anti-pass Back is displayed. See Figure 16-38.

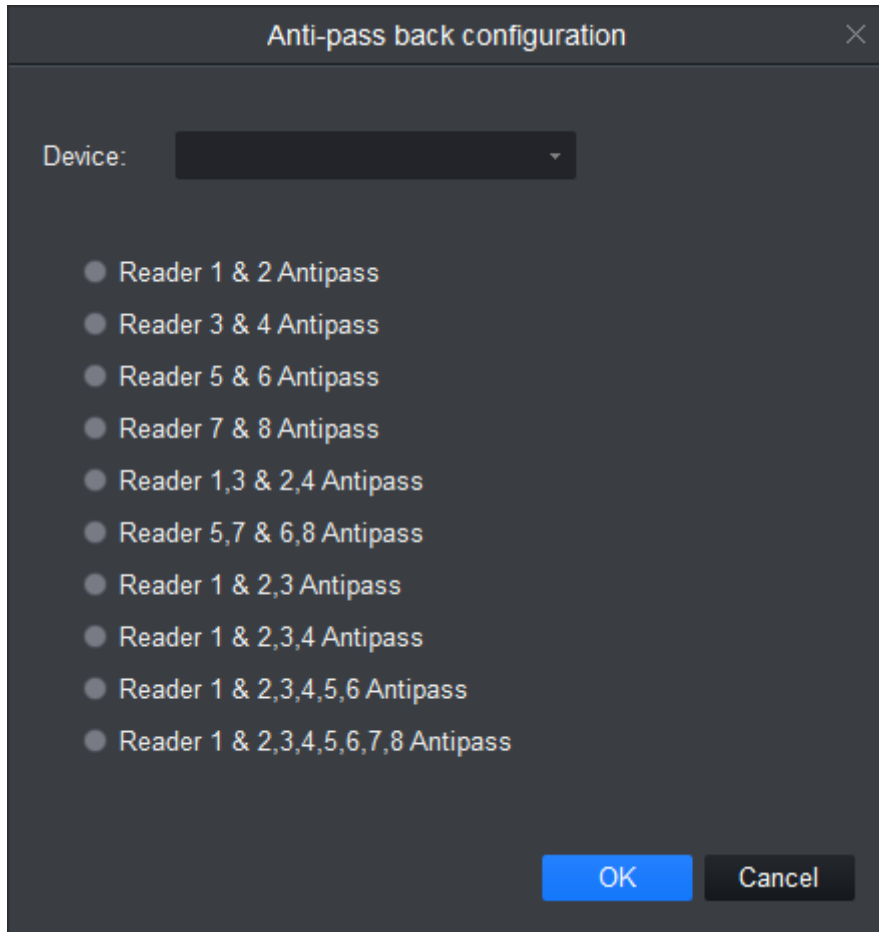

Figure 16-38

Step 2

Click Add. The system displays the interface of Anti-pass Back. See Figure 16-39.

Step 3

Select the device which uses anti-pass back rule and set parameters.

Parameter	Description
Device	Select the device which needs to set anti-pass back rule. If you select multi-door controller, then the system will display the interface shown in Figure 16-39.
Name	Customize anti-pass back rule name.
Reset time (min)	Access card becomes invalid after violating anti-pass back rule. Reset time will become invalidation period.
Period	Select period to implement anti-pass back rule
Remark	Remark info.
Reader group	The sequence of reader group is the sequence of swiping card. Supports max 16 reader groups, each group supports max 16 readers.

It needs to set these parameters when the selected device is multi-door controller.

Chart 16-15

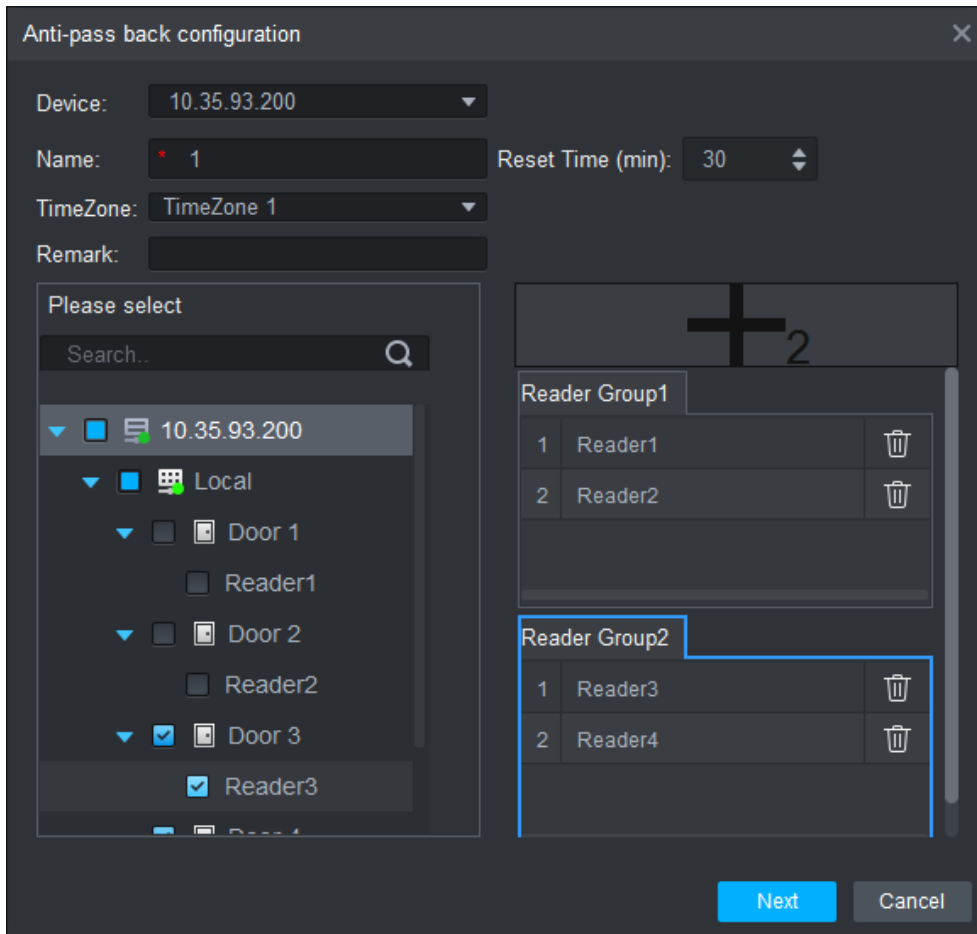

Figure 16-39

Step 4

Click **Next** and the system displays the config interface of anti-pass back. See Figure 16-40

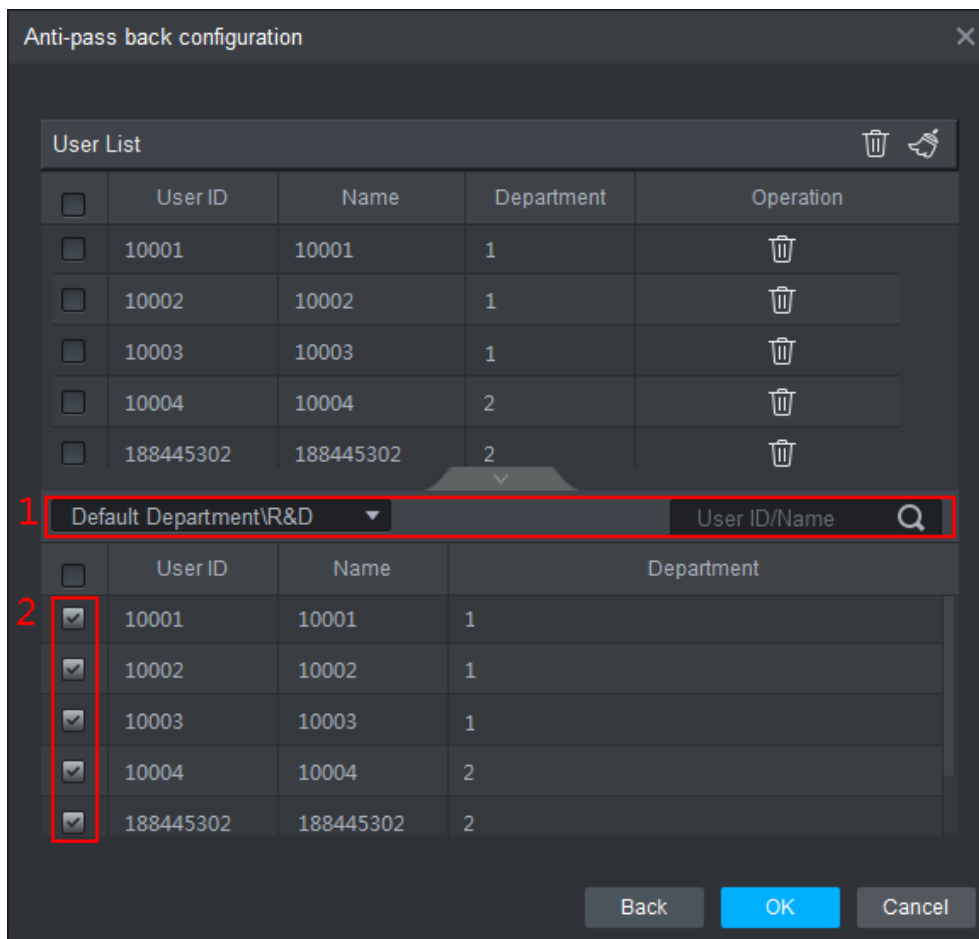

Figure 16-40

Step 5

Search and select personnel by department, number or name.

Step 6

Click OK. The system automatically issues data and anti-pass back setting is completed. Anti-pass back is enabled by default after it is set.

16.3.9 Inter-door Lock

In Permission Management interface, click Inter-door Lock, to set inter-lock between two doors on one access controller. When one door is unlocked, other doors will be locked. If you want to unlock one door (under normal status), all of the others shall be locked, otherwise you cannot unlock this door.

Step 1



Click , select Inter-door Lock.

Inter-door Lock interface is displayed.

Step 2

Click Add. The system displays the interface of **Multi-door Lock**. See Figure 16-41.

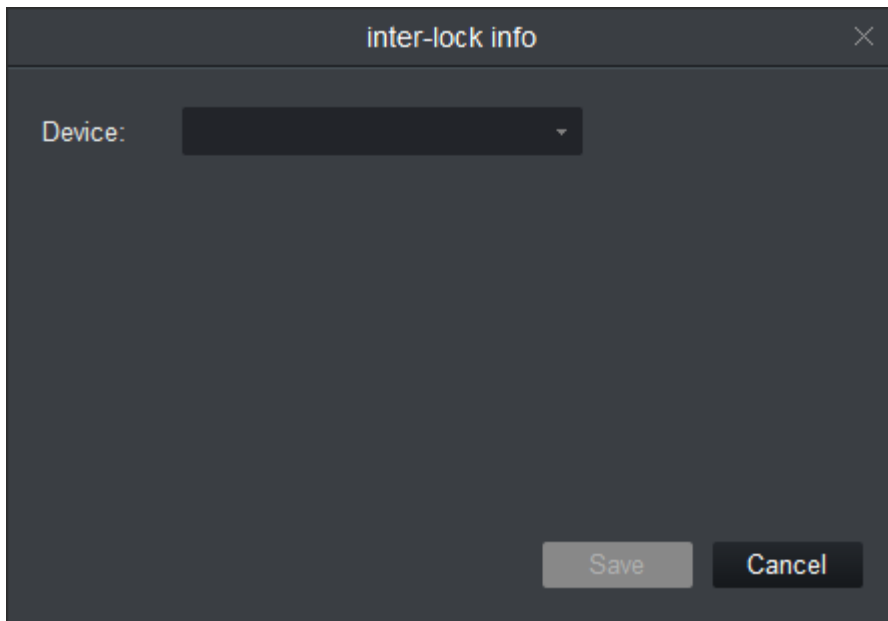

Figure 16-41

Step 3

Select multi-door lock and set parameters. For details, see the following chart.

Parameter	Description
Device	Select the device which needs to set inter-door lock. If you select multi-door controller, then the system displays the interface shown in Figure 16-43.
Name	Customize inter-door lock rule name.
Period	Select the period to implement inter-door lock rule.
Remark	Remark info.
Door group	Inter-lock between door groups. If there is door unlocked in door group 1, then you cannot unlock doors in group 2 unless the door is locked in group 1. Supports max 16 door groups, each group supports max 16 doors.

It needs to set these parameters when the selected device is inter-door controller.

Chart 16-16

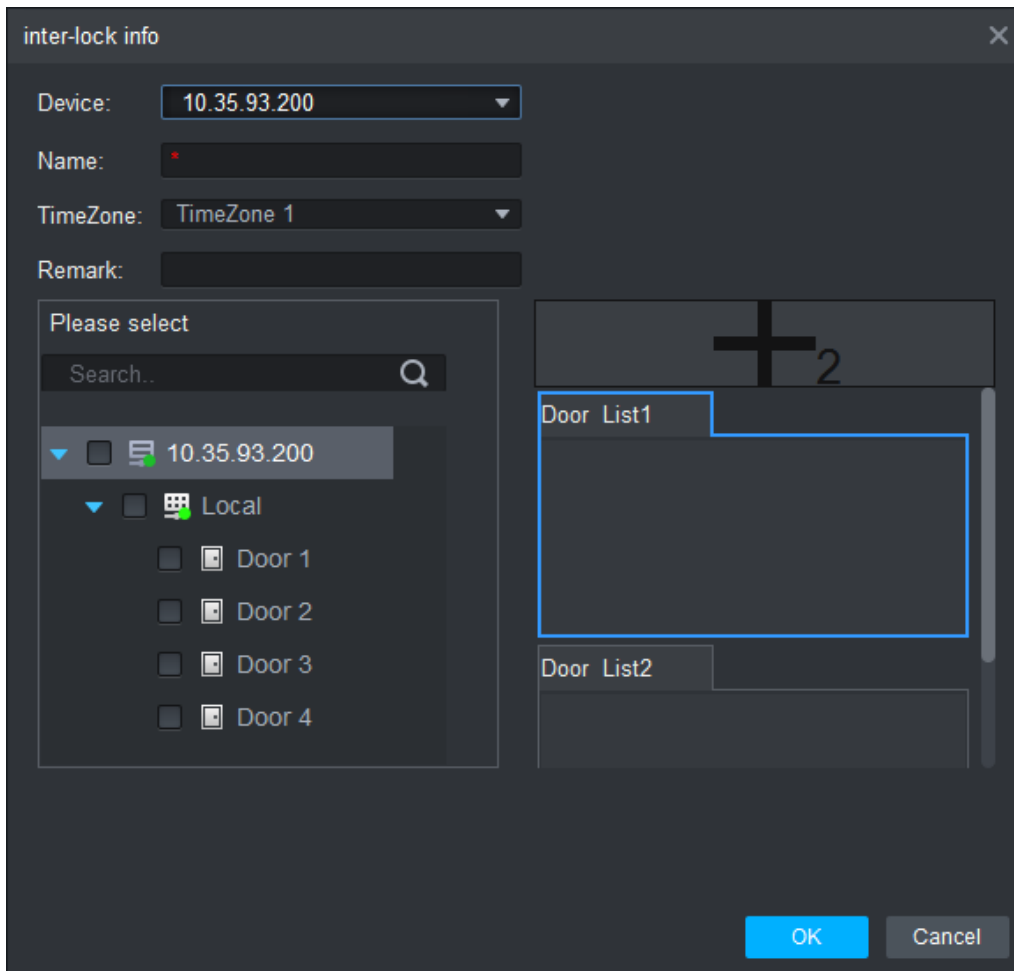

Figure 16-42

Step 4

Click OK. The system will automatically issue data and inter-door lock setting is completed. Inter-door lock config is enabled by default after it is set.

16.3.10 Remote Verification

In Permission Management interface, you can click Remote Verification to ask the client to let user who passes verification enter within certain period, and admin will judge whether to unlock or not.

Step 1

Click , select Remote Verification.

Step 2

Click **Add**. The system will display the interface of **Remote Check**. See Figure 16-43

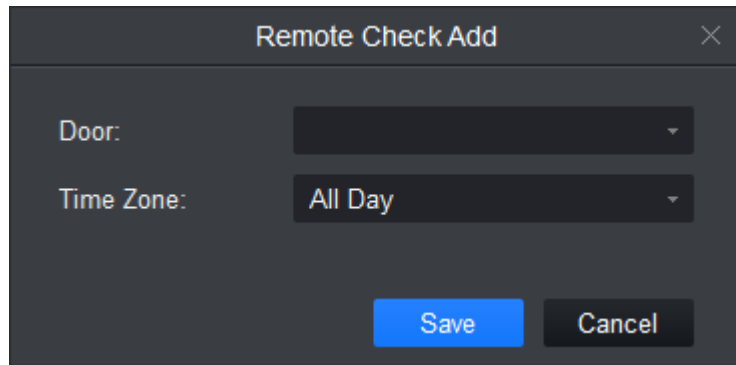

Figure 16-43

Step 3

Select corresponding door and time of enabling remote check.

Step 4

Click Save.

16.4 Event Configuration

In Access interface, you can click Event Configuration. You can set that when a input point inside access system triggers a specific event, client will have video link (live preview/record), link event includes: alarm, abnormal, normal event, link event pop-up plus display in log.

Please refer to the following for configuration of event scheme.

Step 1

Click . See Figure 16-44.

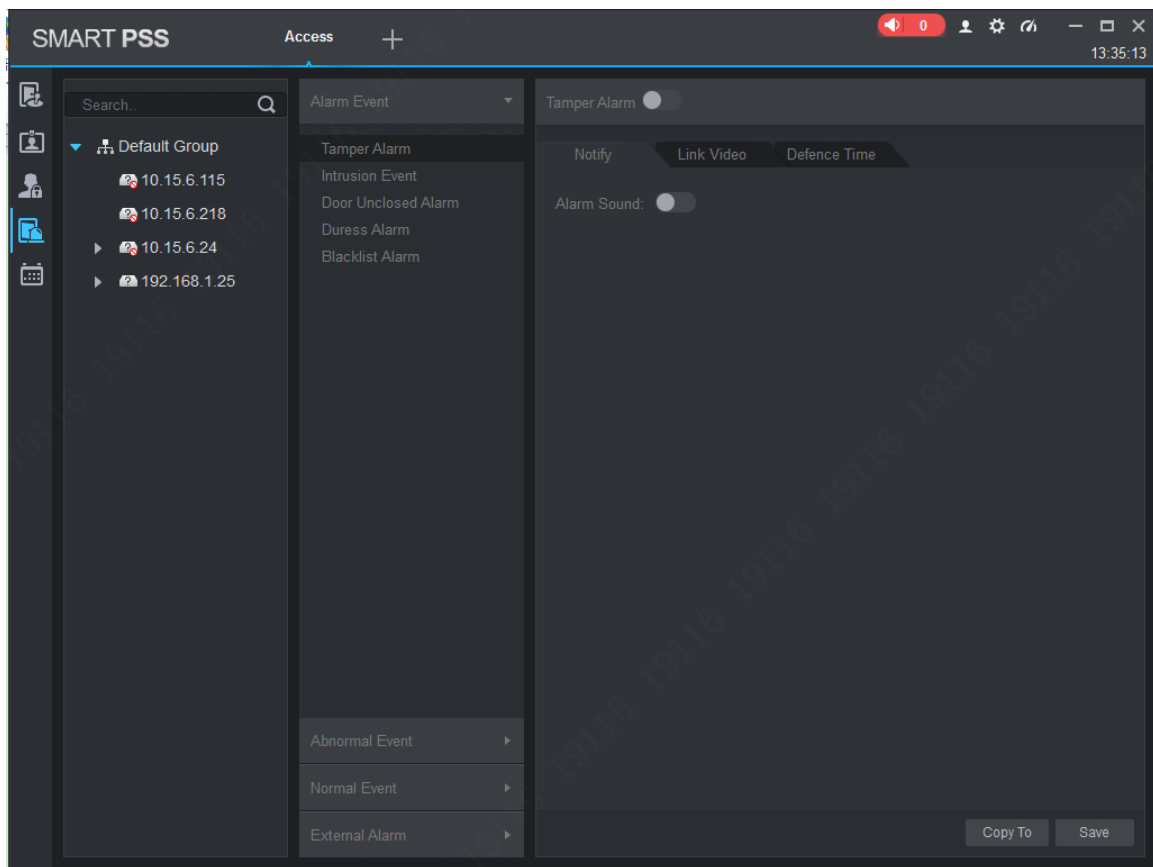

Figure 16-44

Step 2

Select device channel.

Step 3

Select alarm event. Refer to the following chart for more details.

Event Type	Description
Alarm Event	Chassis alarm: Alarm triggered when card reader of the controller is forced to be removed.
	Intrusion alarm: Excluding normal door open conditions, other door open conditions detected by door sensor 1
	Duress alarm: Alarm triggered when door is opened by duress card (fingerprint).
	Door left open alarm: door remained open exceeding set time
	Blacklist alarm: Alarm triggered when door is opened via card on blacklist.
Abnormal Event	Unauthorized or card lost: alarm triggered when the card has no right to unlock this door or it has been reported lost.

Event Type	Description
	Card suspended: After the card is suspended, it cannot be used. Event is triggered at verification.
	Unlock mode error: Event triggered when verification method and unlock method do not match.
	Card validity error: Alarm is triggered when current time is not within card validity.
	Period error: Alarm is triggered when verification of current period is not in access period.
	Holiday unlock period error: Alarm is triggered when verification of current period is not in holiday period.
	Incorrect first card: Enable first card right, alarm is triggered when user unlock not using first card.
	Inter-lock mode: Door with set inter-lock rule is unlocked, alarm it triggered when the other door is unlocked.
	Anti-pass back mode: When one enters via verification but exits without verification, alarm is triggered at his/her next verification for entry.
Normal Event	Lock event: triggered when auto lock or door sensor detects door is locked
	Card unlock: Triggered after passing card verification, door is unlocked
	Fingerprint unlock: Triggered when door is unlocked after passing fingerprint verification.
	Card + fingerprint unlock: Triggered when door is unlocked after passing card and fingerprint verification.
	Card +password unlock: Triggered when door is unlocked after passing card and password verification.
	Password unlock: Triggered when door is opened via password.
	Button unlock: Triggered when door is opened via button.
	Multi-card unlock: Triggered when the first card in multi-card unlock mode passes verification.

Event Type	Description
	Remote verification: Triggered when a user passes device verification and is asking for client verification for door under remote verification.

Chart 16-17

Step 4

Configure alarm linkage. For more details, see **11.2 Event Alarm Link Config**

Step 5

Click Save to complete config.

16.5 Log

In Access interface, you can click Log. You can search for log according to criteria.

Step 1

Click , see Figure 16-45.

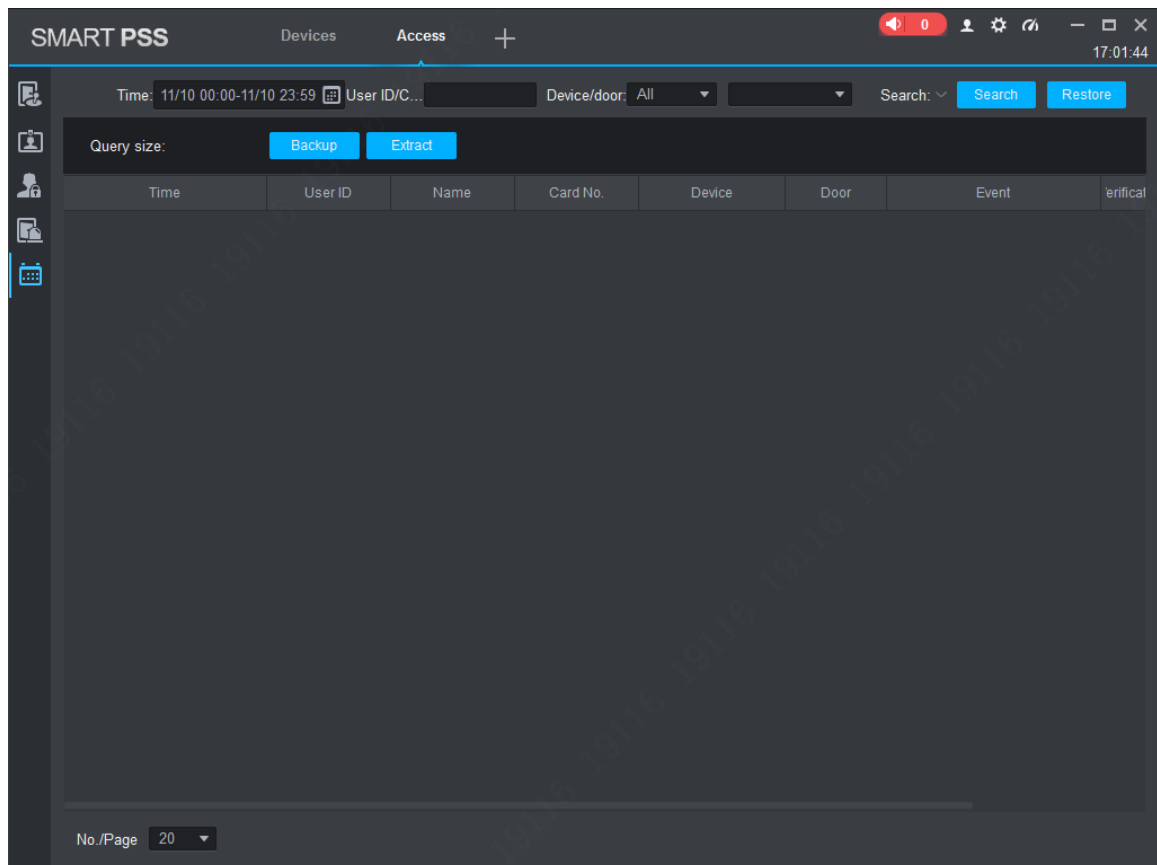

Figure 16-45

Step 2

Set search criteria. Search can cross up to 2 days.

Step 3

Click Search, see Figure 16-46.

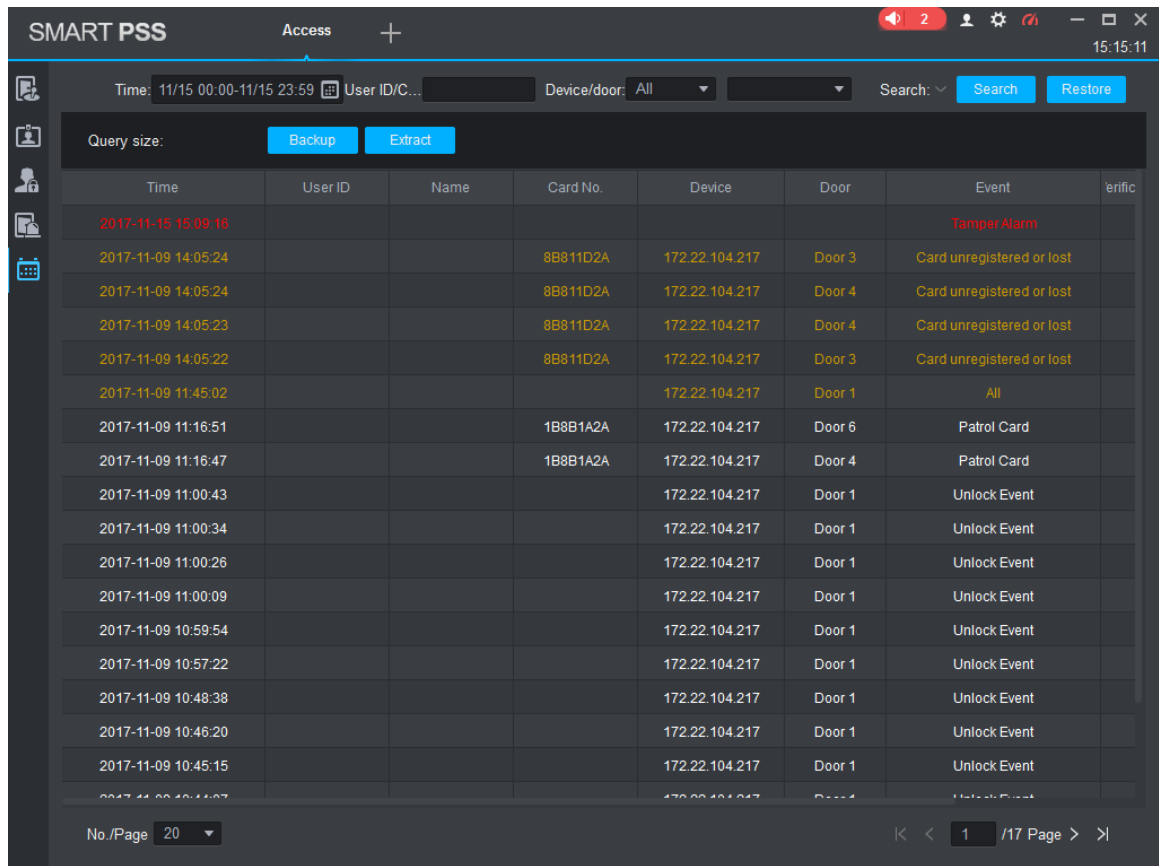
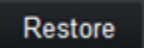
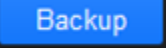
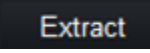





Figure 16-46

You can reset search criteria, export search result and view record.

-  Restore, restore criteria.
-  Backup, export searched log.
-  Extract, extract log info of all devices or selected devices.
-  View record.
-  Open the corresponding scene snapshot of face unlock log.

17. Attendance

It integrates time attendance, and effectively manages and configures devices to fulfill function of time attendance module.

Click , in **New** interface, select Attendance.

17.1 Console

When you use access control device as time attendance, please set A&C device as time attendance in console. If it is paired with time attendance, then you can extract card info on time attendance.

17.1.1 Console Introduction

Click  and the system displays the interface of Console. See Figure 17-2

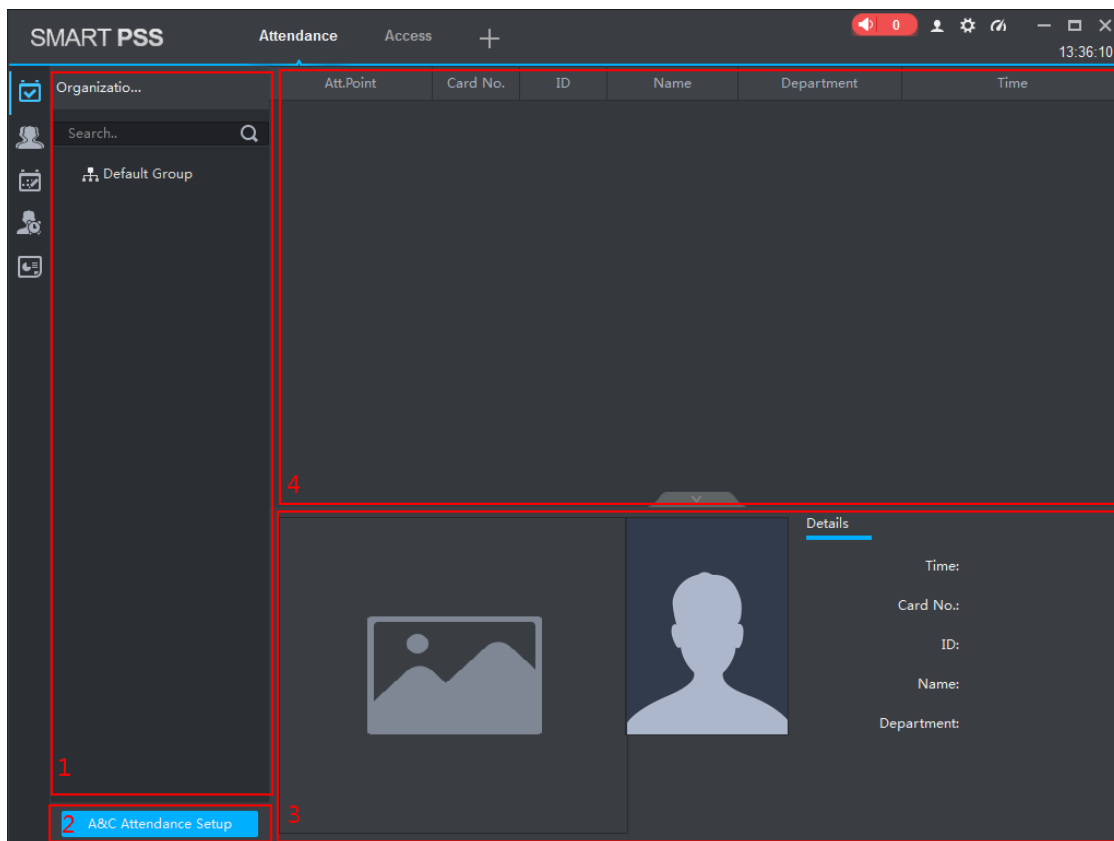

Figure 17-1

SN	Name	Description
1	Organization tree	Display organization tree info, supports new group, rename and delete group.
2	A&C attendance setting	Set access control device as attendance location. Refer to 17.1.2 ACS Attendance Node Setup .



SN	Name	Description
3	Face attendance info display	After face attendance succeeds, it will display scene snapshot, face comparison and relevant personnel info. Click  to hide display area of face attendance info, click  to unfold info display area of face attendance.
4	Attendance info display	Display face attendance record info.

Chart 17-1

17.1.2 ACS Attendance Node Setup

Step 1

Click . See Figure 17-2.

Step 2

Click [ACS attendance node setting](#), see Figure 17-2

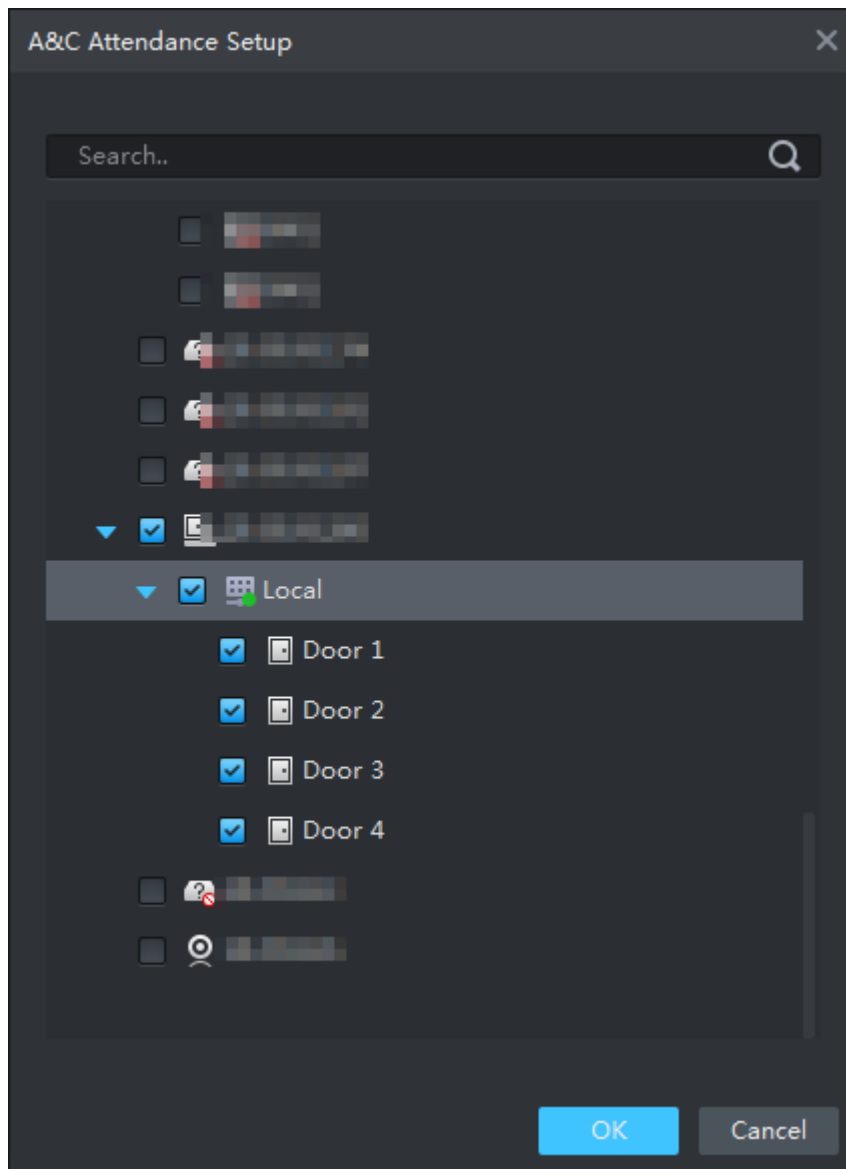

Figure 17-2

Step 3

Select A&C device, click OK. Setup is successful.



- Via search function, you can quickly find device you want, fuzzy is supported.
- If you want to cancel attendance node, please click cancel a&c, click OK.

17.1.3 Extract Card Info

In organization tree, right click designated time attendance and click Extract Card Info. The system will auto extract card info in the time attendance and show user info, including time, card no., no., name and etc.

17.2 User

User includes department management, user management and right management.

17.2.1 Department/User

Department management and user management functions of time attendance are the same with access module, as well as operations are the same. Info in these two modules can be shared.



If you adopt face recognition attendance, the personnel No. has to be in accordance with that of the face database, otherwise, it will fail to trigger face attendance.

17.2.2 Permission

It manages user attendance permission.

17.2.2.1 Enable Attendance Right

You can enable attendance permission of device.

Step 1

Click . See User interface.

Step 2

Click Access Control, see Figure 17-3.

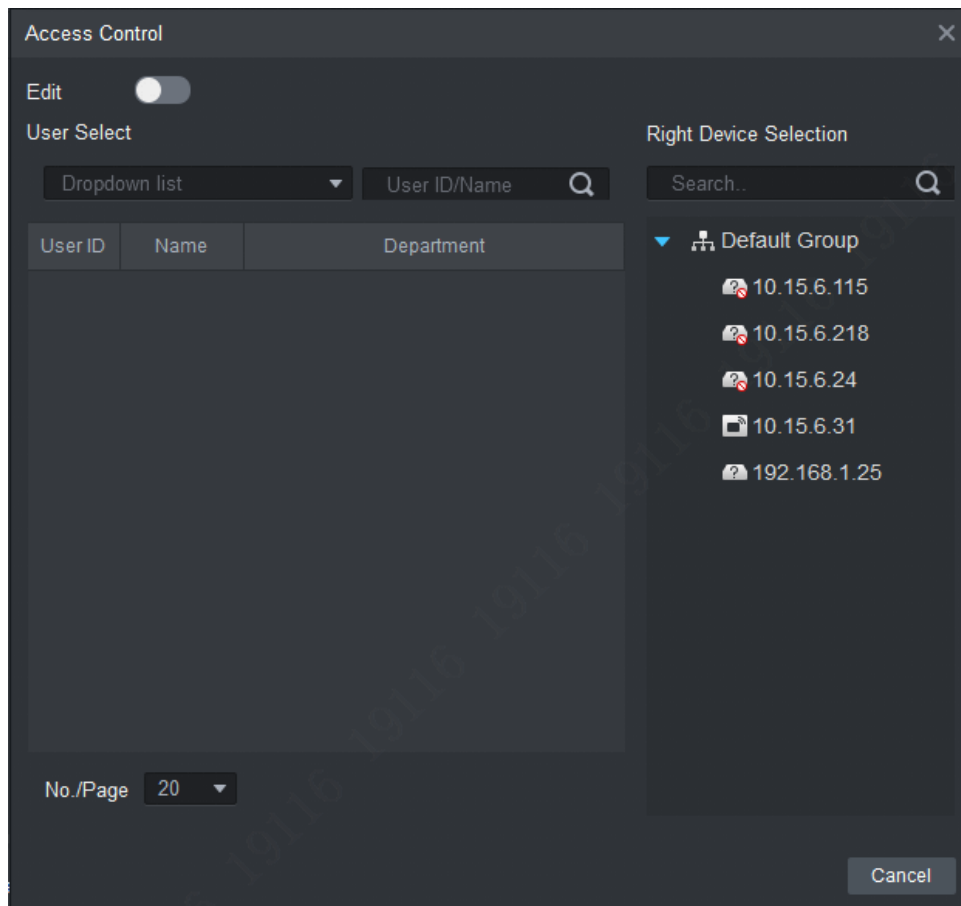

Figure 17-3

Step 3

Click  to enable edit.

Step 4

Select User.

- First select department, and then select users. See Figure 17-4.
- Search user by user ID or name, and select corresponding user, see Figure 17-5.

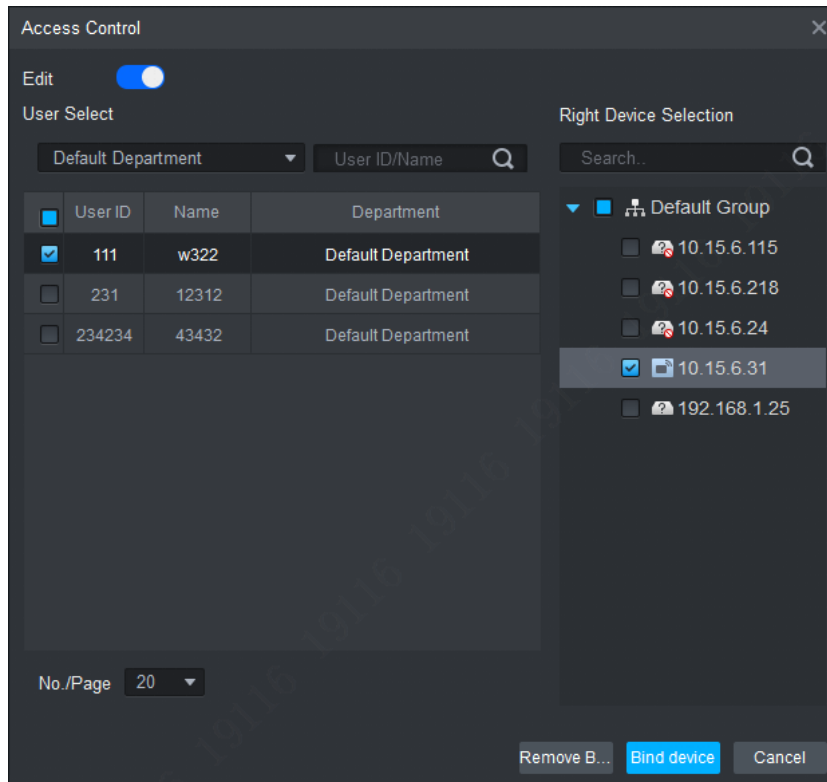

Figure 17-4

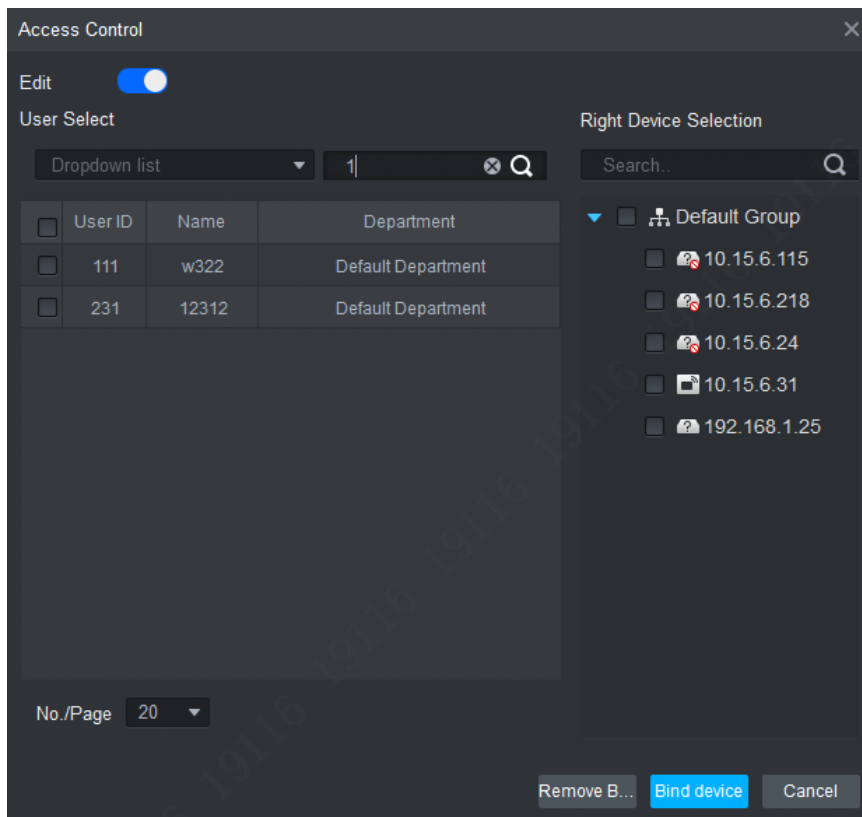

Figure 17-5

Step 5

In device tree, select time attendance. If you want to set more than one device, and to allow employees to sign up on any of these devices, please select more than one

device.

Step 6

Click **Bind Device** and complete config.

17.2.2.2 Disable Attendance Right

Step 1

Click . System shows User interface.

Step 2

Click Access Control, see Figure 17-3.

Step 3

Select user, to view devices supporting sign up, see Figure 17-6.

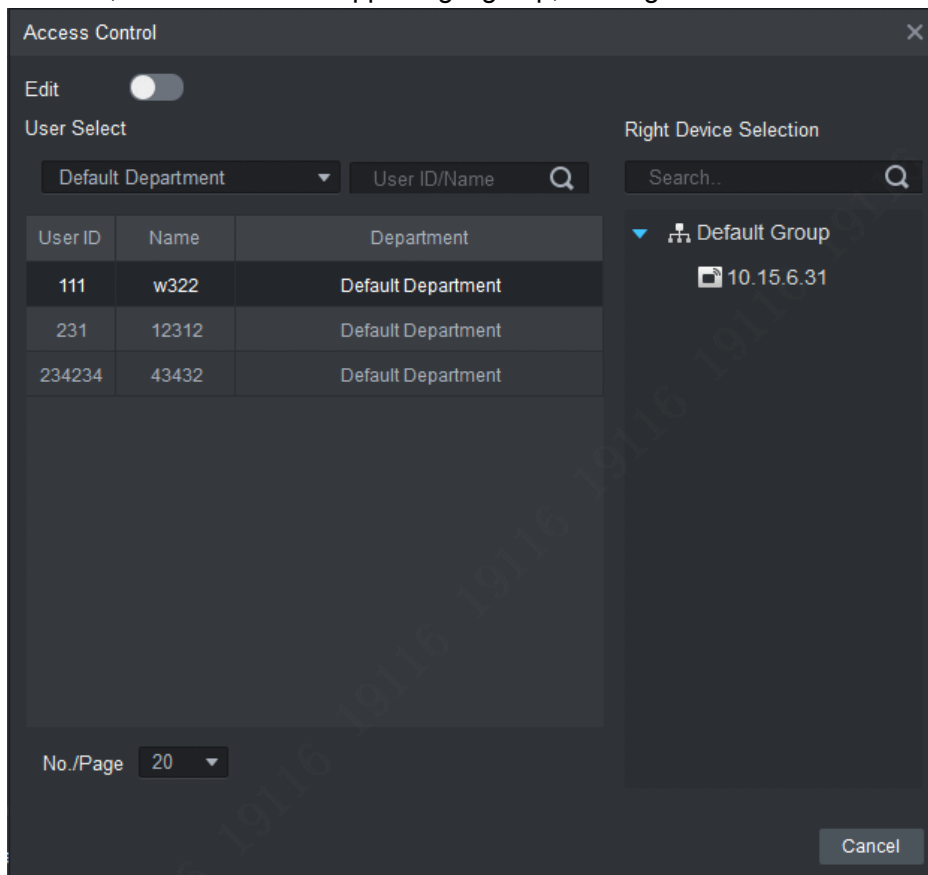

Figure 17-6

Step 4

Click  to enable edit.

Step 5

- Select user.
- First select departments, and then select user, see Figure 17-4.

Step 6

Search user by user ID or name, and select corresponding user, see Figure 17-5.

Step 7

Select time attendance on device tree according to search result.

Click Cancel.

17.3 Set Attendance

Set attendance period, shift and holiday.

17.3.1 Set Attendance Timezone

Set time zone of attendance as attendance proof.

Step 1

Click  and select Attendance Time zone. System shows Attendance Time zone interface.

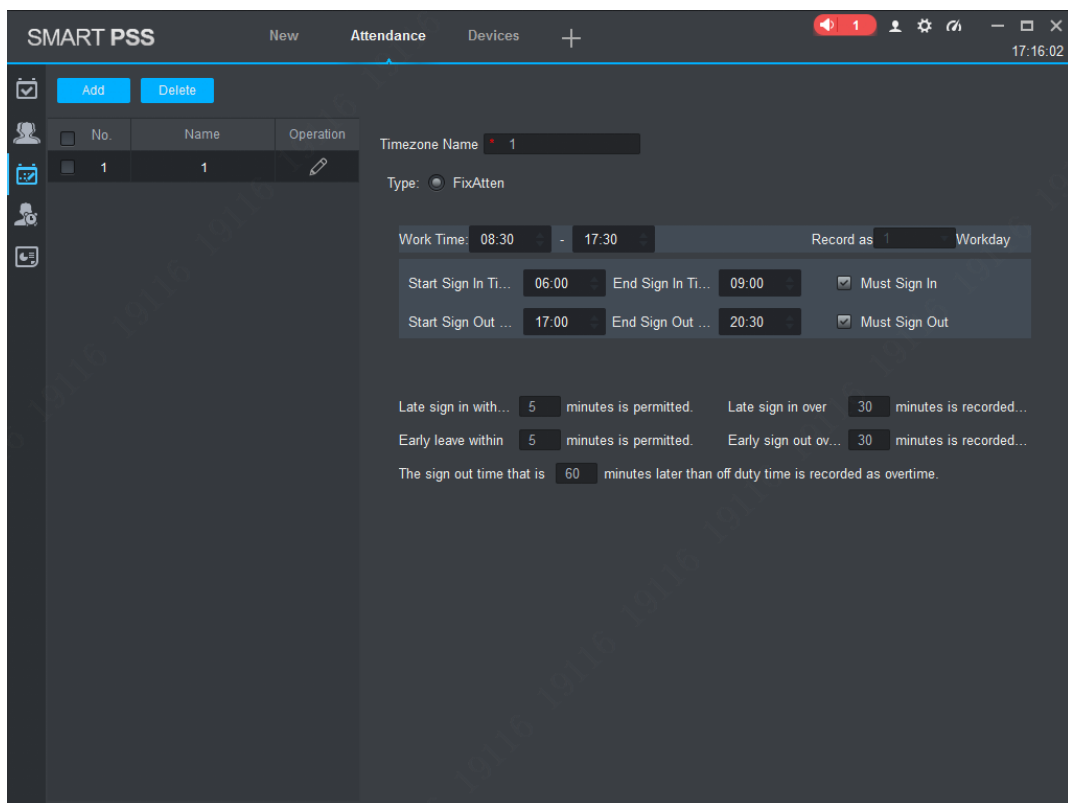

Figure 17-7

Step 2

Click Add.

Systems pops up New Time zone box and see Figure 17-8.

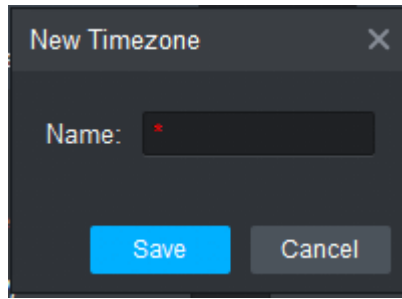



Figure 17-8

Step 3

Enter timezone name (used to identify timezone), click Save.

Step 4

Click  behind timezone to set parameter, see Figure 17-9.

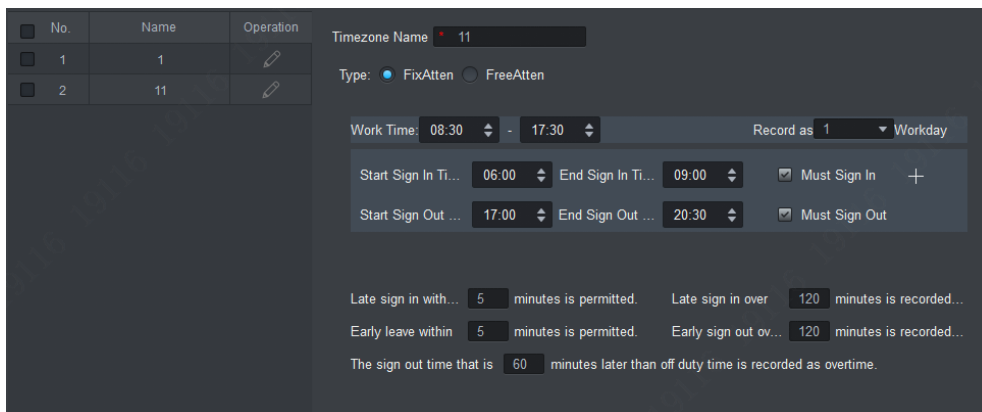



Figure 17-9

Parameter	Note	
Time Zone Name	Customize period name.	
Type	<p>Select work attendance type, including fix and free.</p> <ul style="list-style-type: none"> ● Attendance type is set to fix attendance. For more info, please see the rest of this chart. ● Attendance type is free attendance, and you only need to set duration and whether to limit the latest sign in time. 	
Work Time	Set work time of this period, meantime please select day of week.	
Record as X Workday	One week time is recorded as how many weekdays.	
Start Sign In Time	Sign in only within set period on attendance device.	
End Sign In Time	<ul style="list-style-type: none"> ● If this period of attendance time zone has two separate sub periods, then you shall click  to set second work time sign in/out time. ● If you set two work time, then both time shall have sign in/out to be valid for normal attendance. 	
Start Sign Out Time		Sign out only within set period on attendance device.
End Sign Out Time		
Late sign in within X minutes is permitted.	Define late, early leave and absence. You can set different time ranges, the followings are example only.	

Late sign in over X minutes is recorded as absence.	Set start time of work time has standard sign in time. Actual time later is than this time, within $5 \text{ min} < X \leq 30 \text{ min}$, will be late.
Early leave within X minutes is permitted.	Set start time of work time has standard sign in time. Actual time later is than this time, $X > 30 \text{ min}$, will be absence.
Early sign out over X minutes is recorded as absence.	Set end time of work time has standard sign out time. Actual sign out is earlier than this time, and $0 \text{ min} < X \leq 5 \text{ min}$, will be early leave.
The sign out time that is X minutes later than off duty time is recorded as overtime.	Set end time of work time has standard sign out time. Actual sign out is earlier than this time, and $5 \text{ min} < X \leq 30 \text{ min}$, will be absence. Set end time of work is standard off duty time. Actual sign out time later than this time, and over set value will be overtime.

Chart 17-2

Step 5

Click Save, to save time config.



- Edit attendance time zone: click  next to attendance time zone to modify.
- Delete attendance time zone: select attendance time zone, click Delete.
- You cannot delete period in progress. If you want to delete it, please go to attendance shift interface and check all shifts to found those linked to the period in progress. If there are linked shifts, please cancel the link first.

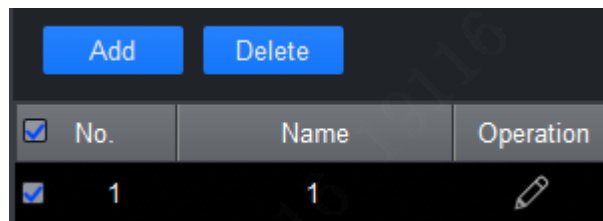

Figure 17-10

17.3.2 Set Attendance Shift

According to attendance time zone, set attendance shift, used for user shift.

Step 1

Click  and select Attendance Shift. See Figure 17-11.

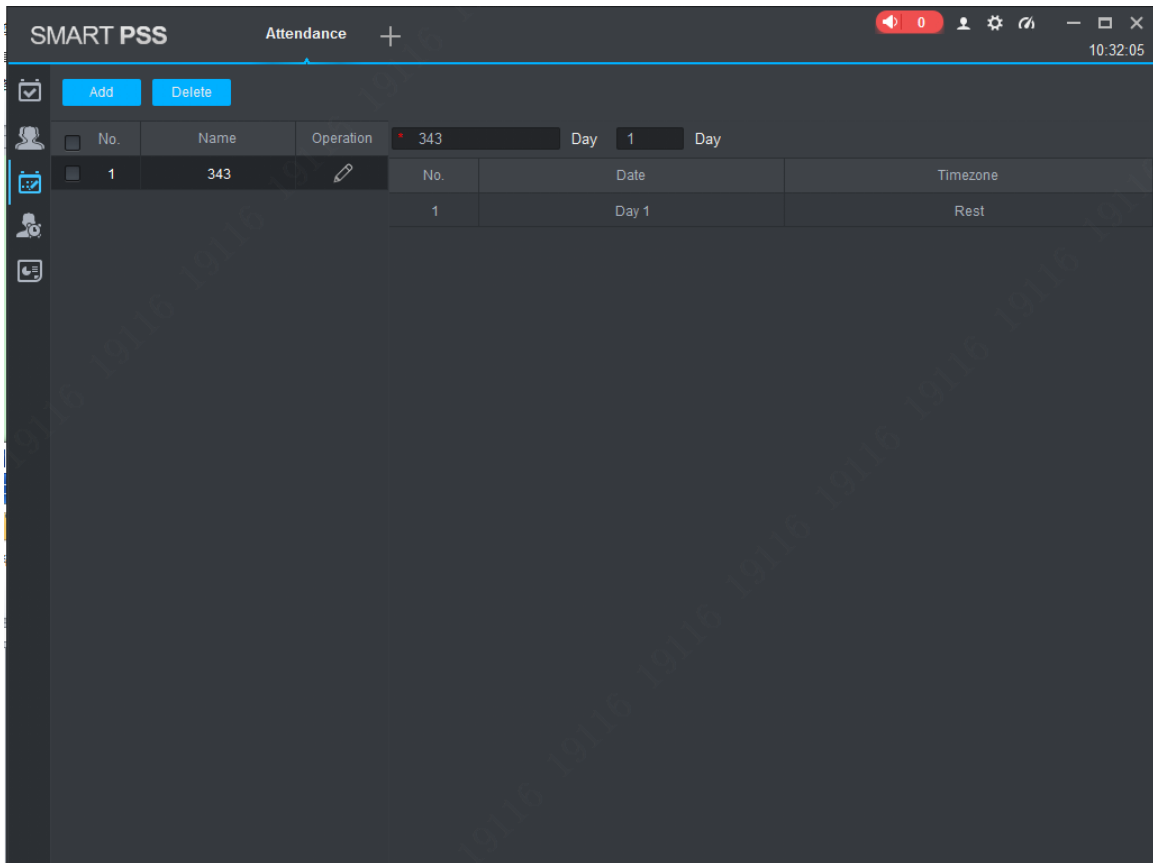

Figure 17-11

Step 2

Click Add. See Figure 17-12.

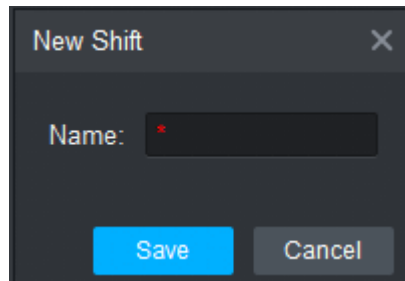



Figure 17-12

Step 3

Enter shift name (name used to differentiate shift), click **Save**.

Step 4

Click  next to shift to set. See Figure 17-13.

No.	Name	Operation	21231 Week			
1	343		No.	Date	Timezone	Operation
2	21231		1	Sun	Rest	Enable all
			2	Mon	1	Enable all
			3	Tue	1	Enable all
			4	Wed	1	Enable all
			5	Thu	1	Enable all
			6	Fri	1	Enable all
			7	Sat	Rest	Enable all

Figure 17-13

Parameter	Note
Shift Name	Change shift name.
Week Date	Select shift period: <ul style="list-style-type: none"> • Week Shift by week, recommended here. After you select week, you can set Monday to Sunday as attendance time zone. Date column will show date as Sunday to Saturday. • Month Shift by month, recommended here. After you select month, you can set day 1 to day 31. • Day Shift by day, recommended here. After you select day, you can set day of shift. N in Day column means no. N day.
Time Zone	Set shift or rest.
Operation	Click Enable All to set time zone of current shift to all other dates.

Chart 17-3

Step 5

Click Save.



- Edit attendance shift: click next to attendance shift to modify attendance shift info.
- Delete attendance shift: select attendance shift, click Delete to delete shift.
- You cannot delete shift in progress. If you want to delete it, please go to attendance shift interface and check all shifts to found those linked to the shift in progress. If there are linked shifts, please cancel the link first.

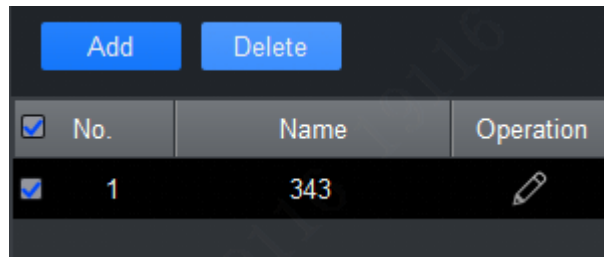

Figure 17-14

17.3.3 Set Holiday

If you have set a date to be holiday, so in general shift shall not set shift on this date, and you can set shift on this date via temporary shift.

Step 1

Click  and select Holiday. See Figure 17-15.

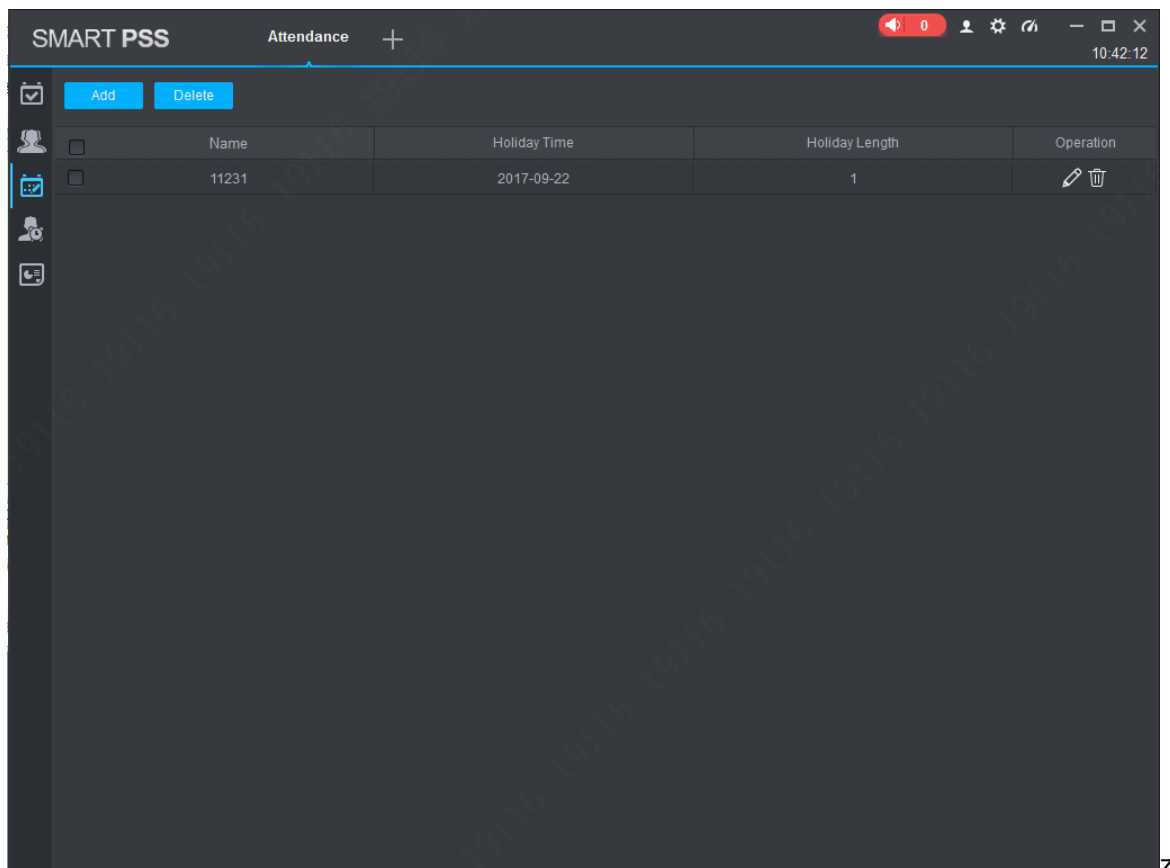

Figure 17-15

Step 2

Click Add. See Figure 17-16.

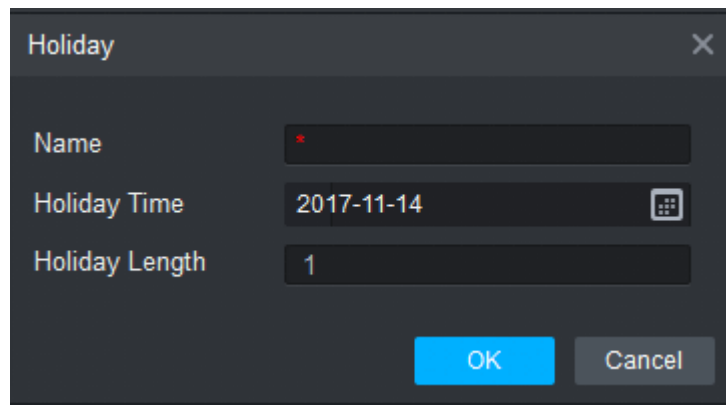

Figure 17-16

Step 3

Set holiday parameter.



Function	Note
Name	Enter holiday name.
Holiday Time	Set holiday date. If holiday is more than one day, you only need to set the first time. Click  to adjust date, select time, and click OK.
Holiday Length	Set length of holiday.

Chart 17-4

Step 4

Click Save.



- Edit holiday: click  next to holiday to modify holiday info.
- Delete holiday: select holiday, click  Delete to delete holiday.
- Batch delete: select holiday (is selected), click Delete.

17.3.4 Configuring Player

Connect the SmartPSS to the player, and then you can view real-time attendance information on the player

Step 1

On Attendance interface, click  and select Player Config.

The system displays the interface of Player Config. See Figure 17-19.

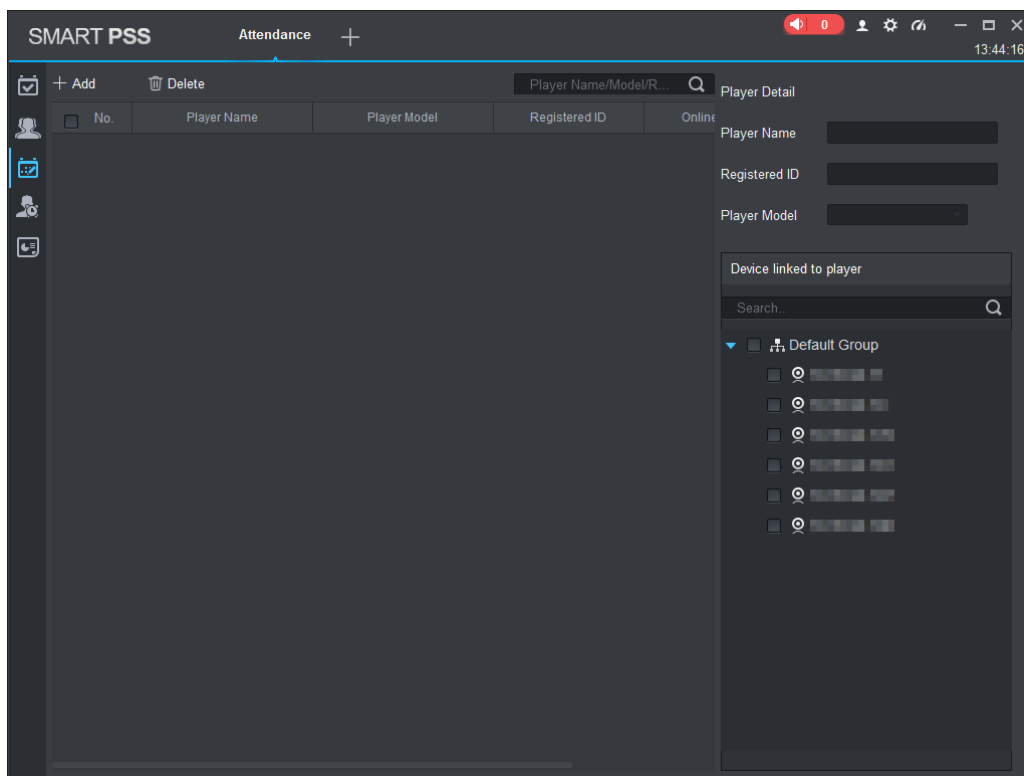

Figure 17-17

Step 2

Click Add and add attendance player information, select associated device. See the following chart for more details.



The player-associated device is the access control attendance location added by console. Please refer to **17.1.2 ACS Attendance Node Setup**

Parameter	Description
Player name	Set player name.
Registration ID	Set player connection ID. The registration code of attendance APP set on digital signage needs to be in accordance with the connection ID, and then it can be well connected.
Player model	Select optional model of digital signage.
Device associated with player	After connected, it will play video data and attendance results of associated device on the digital signage.

Chart 17-5

Step 3

Click **OK**.

17.4 Shift

User shift has general shift and temporary shift.

17.4.1 General Shift

According to attendance user need, set shift.



Edit existing user shift, steps are same with user shift.

Step 1

Click . See Figure 17-18.

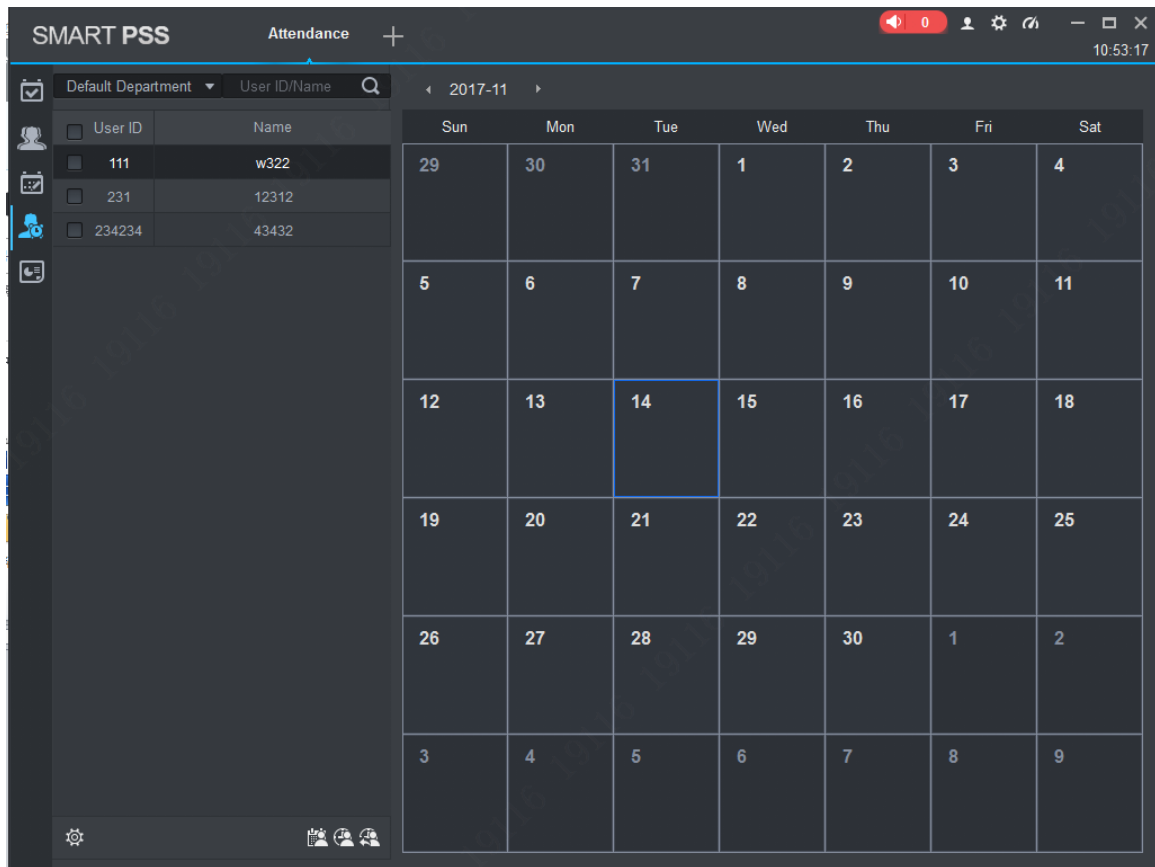

Figure 17-18

Step 2

Select user.

1. Select department. System shows all users in this department.

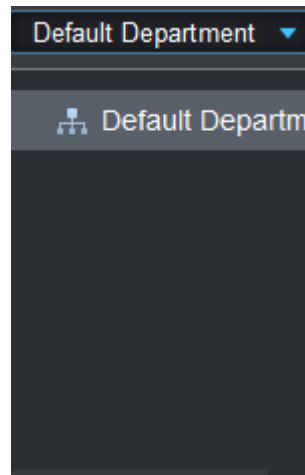

Figure 17-19

2. Select user. See Figure 17-20.

<input checked="" type="checkbox"/> User ID	Name
<input type="checkbox"/> 111	w322
<input checked="" type="checkbox"/> 231	12312
<input type="checkbox"/> 234234	43432

Figure 17-20

Step 3

Click .

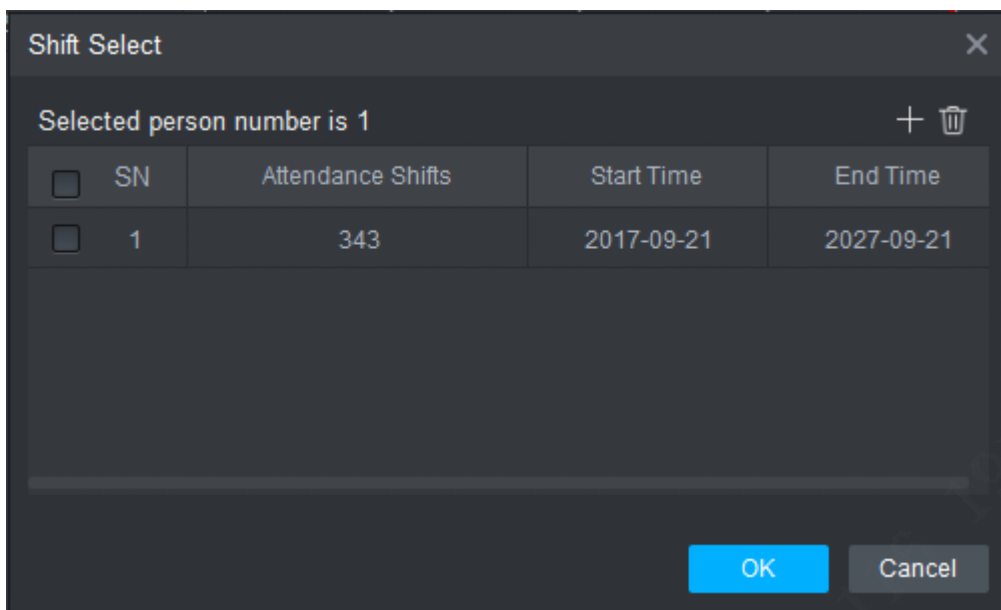



Figure 17-21

Step 4

Add shift info.



- You can add more shift info.
- If you want to delete added shift info (is selected), select shift info and click  to delete.

1. Click  to add one shift info. See Figure 17-22.

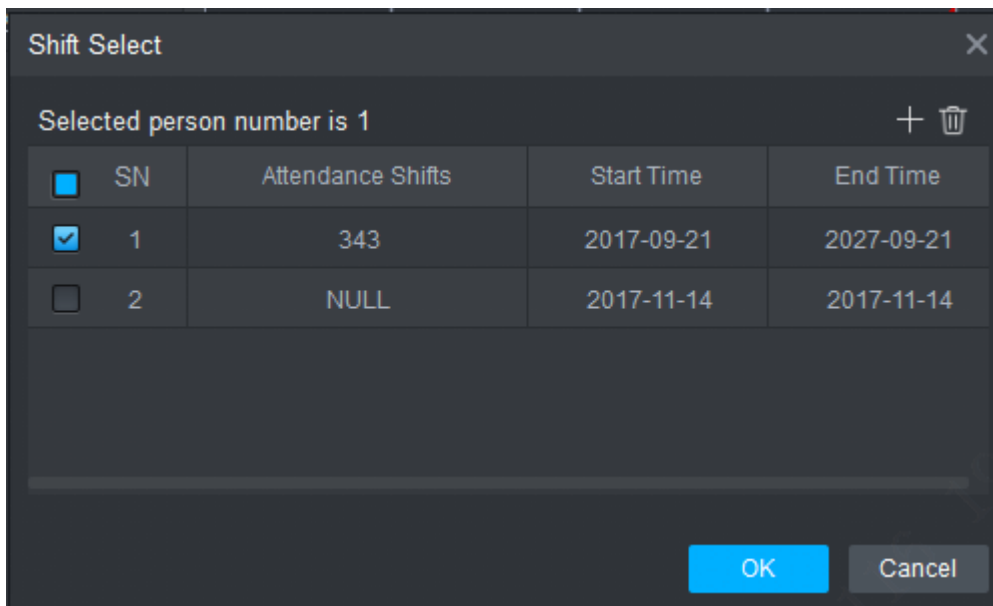

Figure 17-22

2. Set parameter.

Parameter	Note
Attendance Shift	Select shift you need. Please refer to attendance shift in 17.3.2 Set Attendance Shift Click corresponding position in shift bar as shift 1 in Figure 17-24 enter edit status and click value you want.
Start Time	Set user shift start date and end date. Click bar of start time and select date and time in calendar.
End Time	

Chart 17-6

Step 5

Click OK.

17.4.2 Temporary Shift

Temporary shift as an emergent event occur and you shall add temporary shift to user. You can add and delete temporary shift.

Add Temporary Shift

Step 1

Click .

Step 2

Select user.

1. Select department. See Figure 17-19.

System shows all users in this department.

2. Select user. See Figure 17-20.

Step 3

Add temporary shift.

You can add temporary shift via the following methods:

- Select date (show blue box to mean selected), click .
- Double click date.

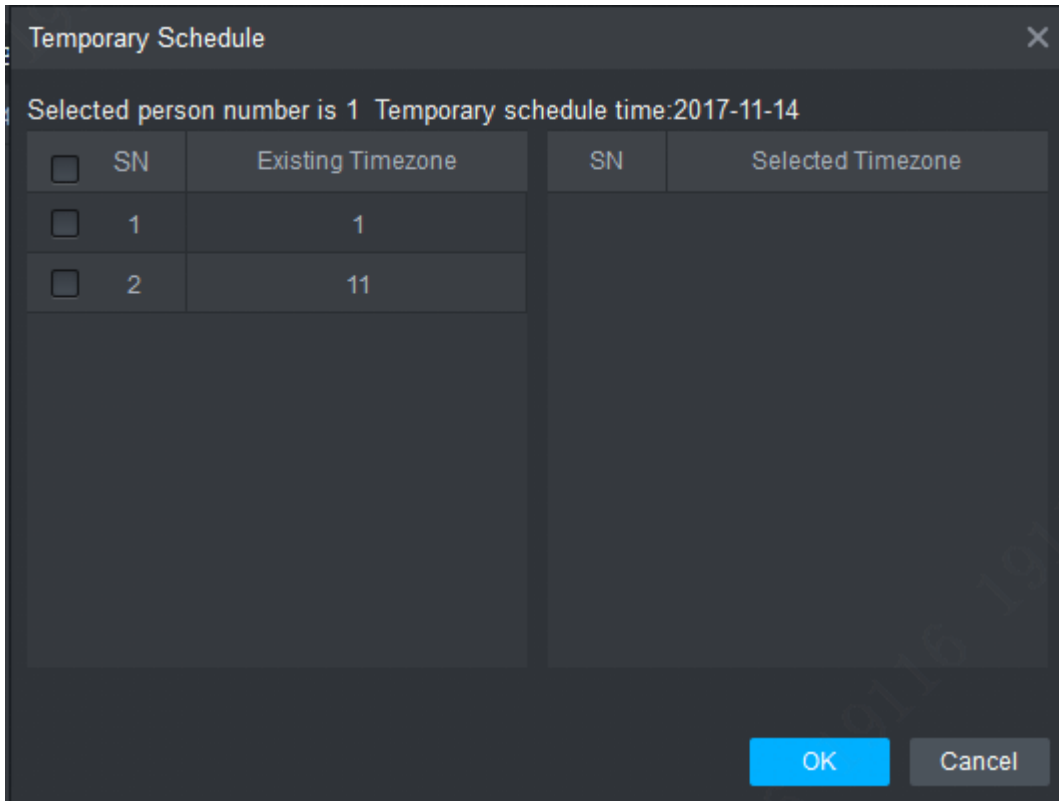

Figure 17-23

Step 4

Select timezone. Click OK

Cancel Temporary Shift

Step 1

Click .

Step 2

Select user.

1. Select department. See Figure 17-19.
System shows all users in this department.
2. Select user. See Figure 17-20.

Step 3

Cancel temporary shift.

You can cancel temporary shift via the following methods:

- Right click date with temporary shift, select Cancel temporary shift to cancel temporary shift.

- Select date with temporary shift (blue box means selected), click . Confirm to cancel.



Blue "T" in calendar means that this date has temporary shift.

17.4.3 Set Default Shift for New User

After you set default shift for new user, when a user is added, he/she has this shift by default.



Repeat the following steps to link default shift to more than one department.

Step 1

Click . See Figure 17-18.

Step 2

Select department, see Figure 17-19.

Step 3

Click . See Figure 17-24.

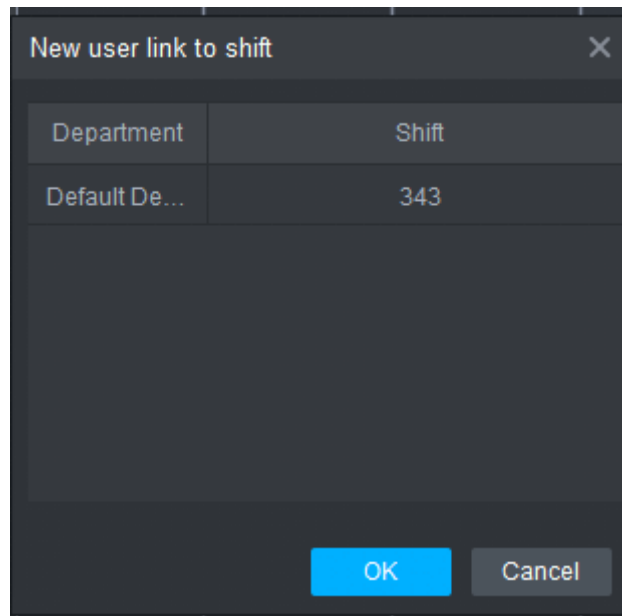

Figure 17-24

Step 4

Click department and select link shift.

Step 5

Click **OK**.

17.5 Report

In Report interface, you can search and extract statistical info. It supports processing of abnormal attendance.

17.5.1 Extract Attendance Info

If attendance info is only saved at local, then you can extract attendance info into client.

Step 1

Click . See Figure 17-25.

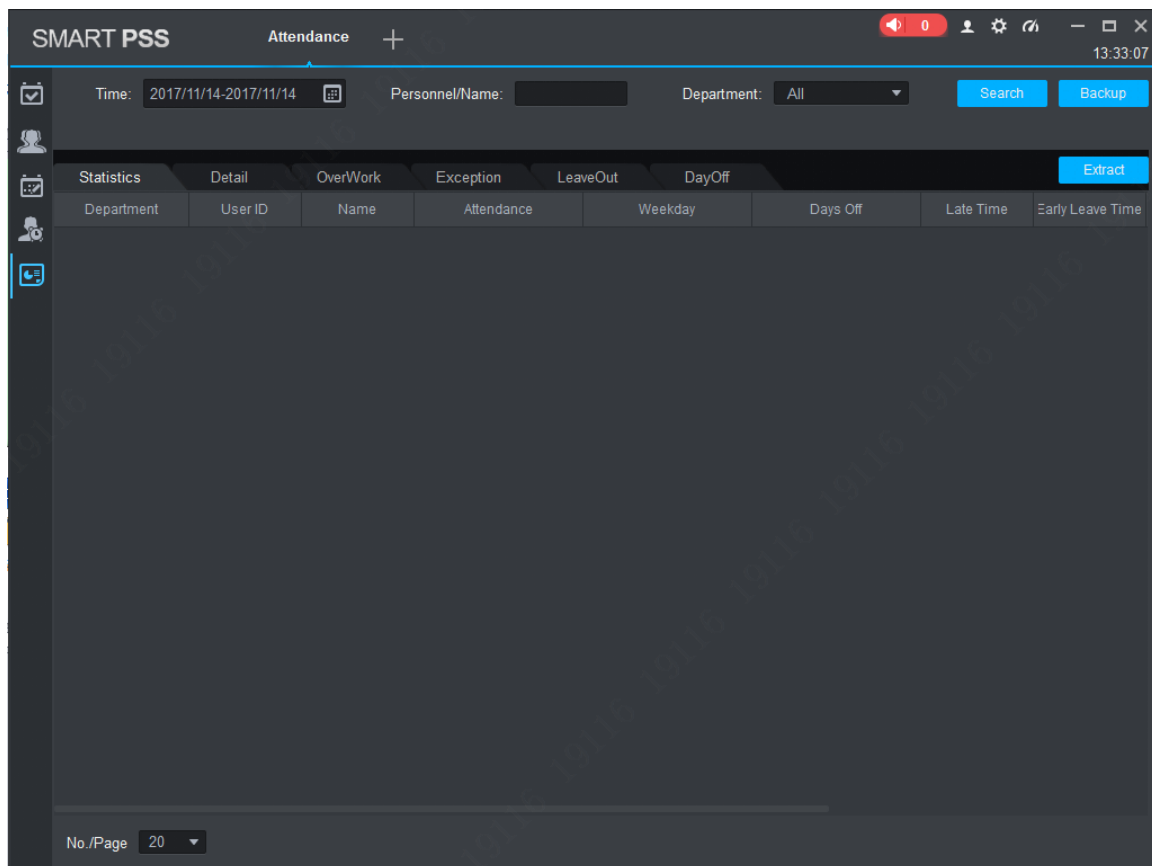

Figure 17-25

Step 2

Click Extract. System shows Manual Extract Record interface, see Figure 17-26.

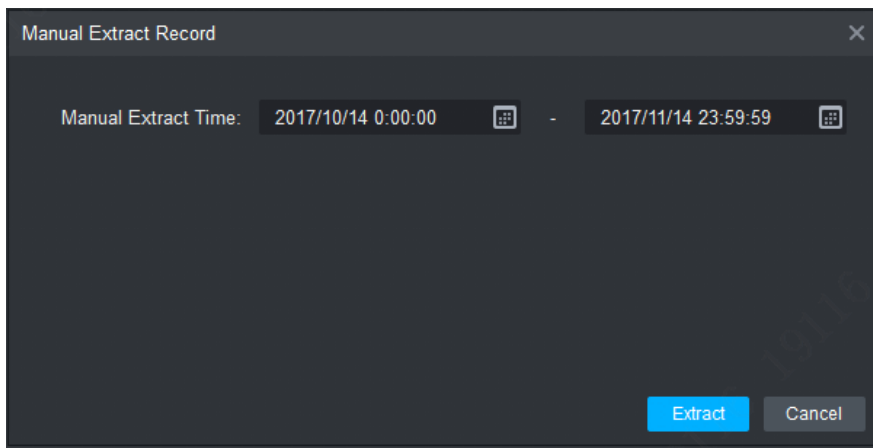

Figure 17-26

Step 3

Set manual extract time and date, click Extract.



After you extract attendance info, you shall click Search button to refresh attendance info.

17.5.2 Attendance Statistics

It supports statistics of attendance by time, user or department and export to local.

Step 1

Click . See Figure 17-25.

Step 2

Click tab you want to view, see Figure 17-27.

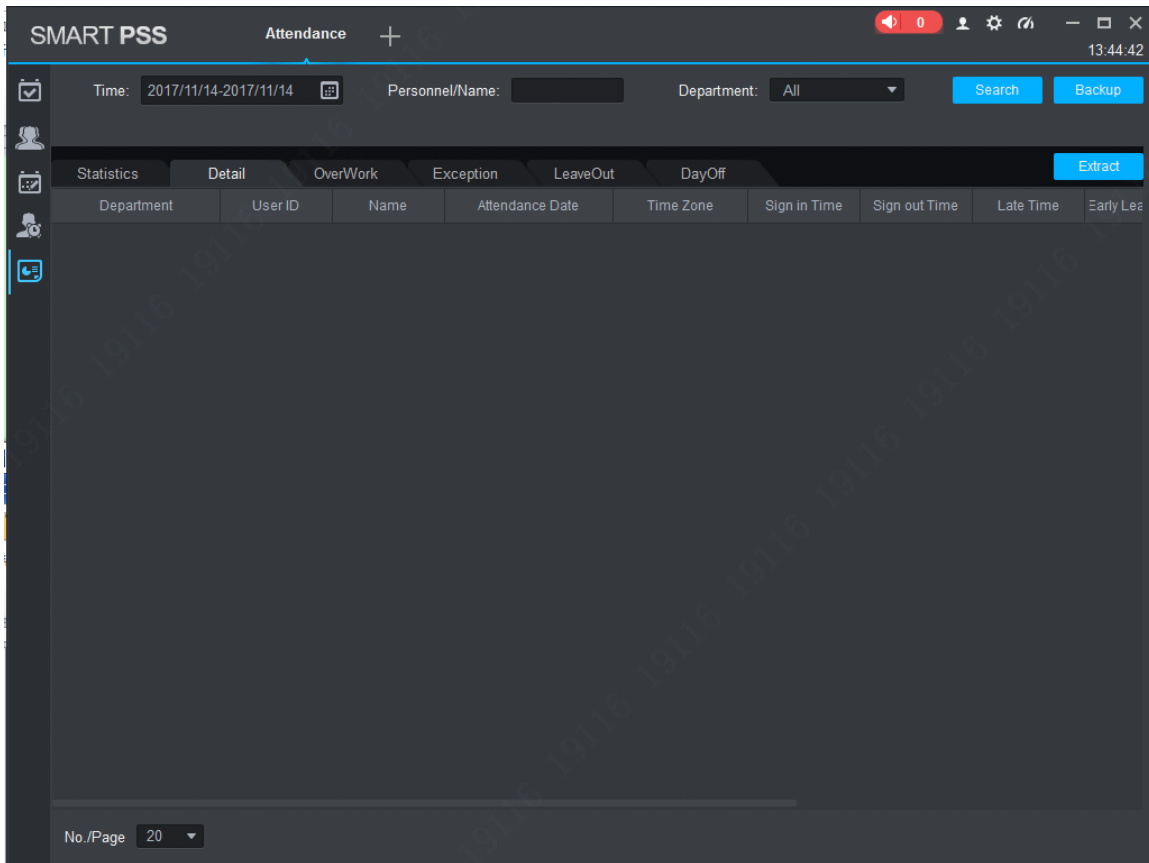

Figure 17-27

Step 3

Click Extract to save result as xlsx file at local.

17.5.3 Exception Attendance Processing

Abnormal attendance processing including absence as off duty, or late or early leave fixes.

Step 1

Click . See Figure 17-25.

Step 2

Click **Exception** tab.

Step 3

Set search criteria and click Search. See Search, see Figure 17-28.

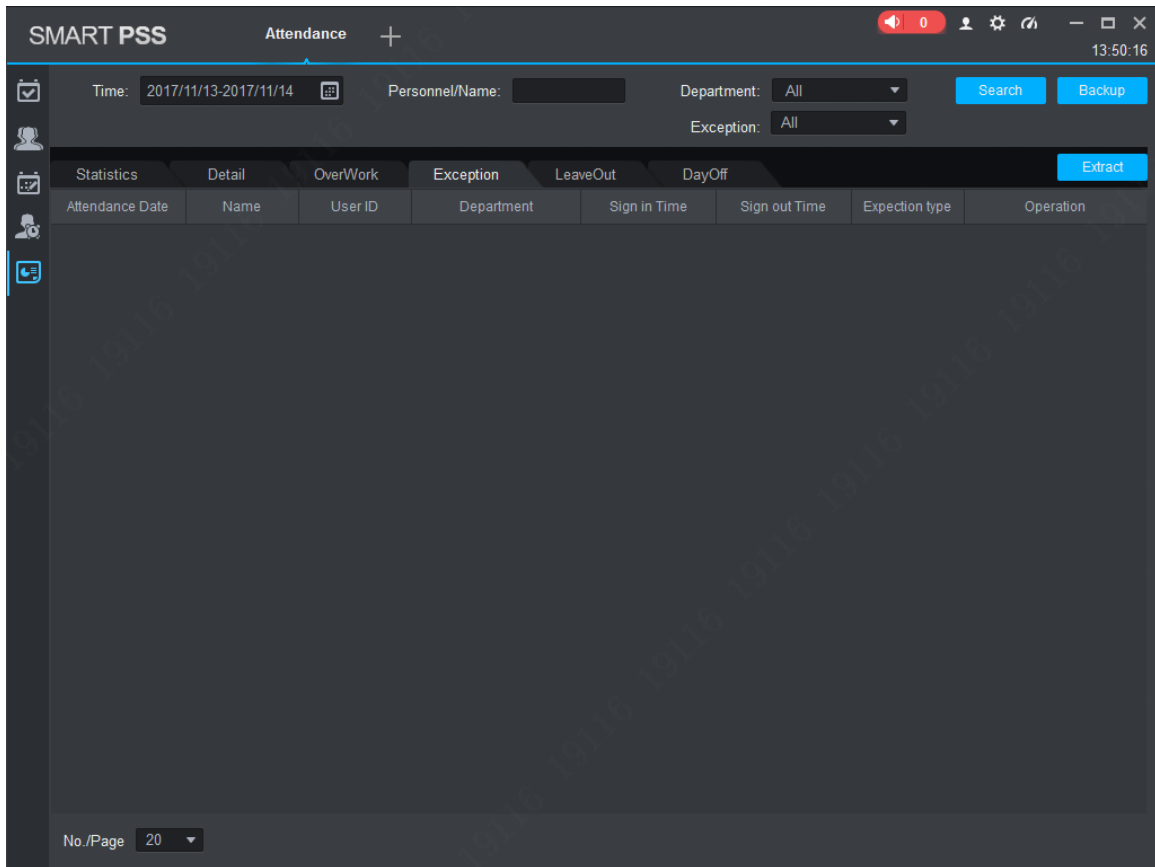



Figure 17-28

Step 4

Click  of item you want to change. In the pop-up window, fix attendance accordingly.

If you want to set exception to off duty, then this fixed item will be no longer shown in exception and meantime an off duty request is created.

18. Face Recognition

A collection of face recognition functions, SmartPSS enables face library management, taking snapshot of people, displaying the person comparison results, and searching for snapshots and comparison results.

 NOTE

SmartPSS is compatible with a variety of face recognition devices, including IVSS, smart NVR, and face recognition cameras. Before using the face recognition function, add proper devices that best suit your needs. See 3 Devices.

By default, face snapshots are stored in C:\Users\Public\SmartPSS\FacePictures. To change it, go to the System Config interface. See 8 System Config.

Click  and select Face Recognition in the New Functions interface. The Face Recognition interface is displayed.

18.1 Face Recognition Settings

Face recognition settings let you:

- Add a face library for storing face information to arm the library, thus placing all faces in the library under extensive surveillance. Edit and delete a face library.
- Add persons into a face library. Edit and delete a person.
- Arm and disarm a face library. After a face library is armed, face recognition devices (such as face recognition cameras, IVSS) compare snapshots against face pictures stored in the library. If the similarity is judged to be \geq the preset value, the face recognition device considers the two comparison subjects as one person, and uploads the comparison results to the client.

18.1.1 Managing face library

18.1.1.1 Adding face library

You can add up to five face libraries (10,000 faces) to a face recognition camera, and up to 20 face libraries (200,000 faces) to a smart NVR or IVSS.

Step 1

Click .

The Face Library Management interface is displayed. See Figure 18-1.

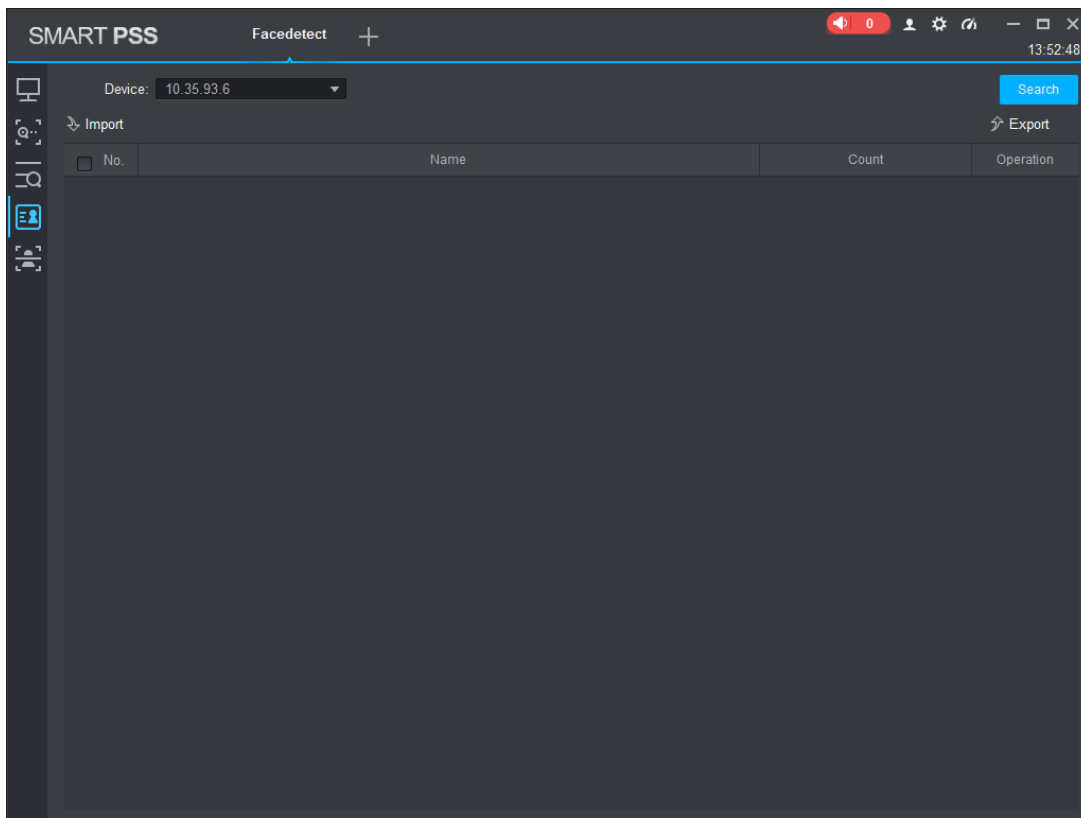

Figure 18-1

Step 2

Select Device and click Search.

The system reads and displays existing face libraries. See Figure 18-2.

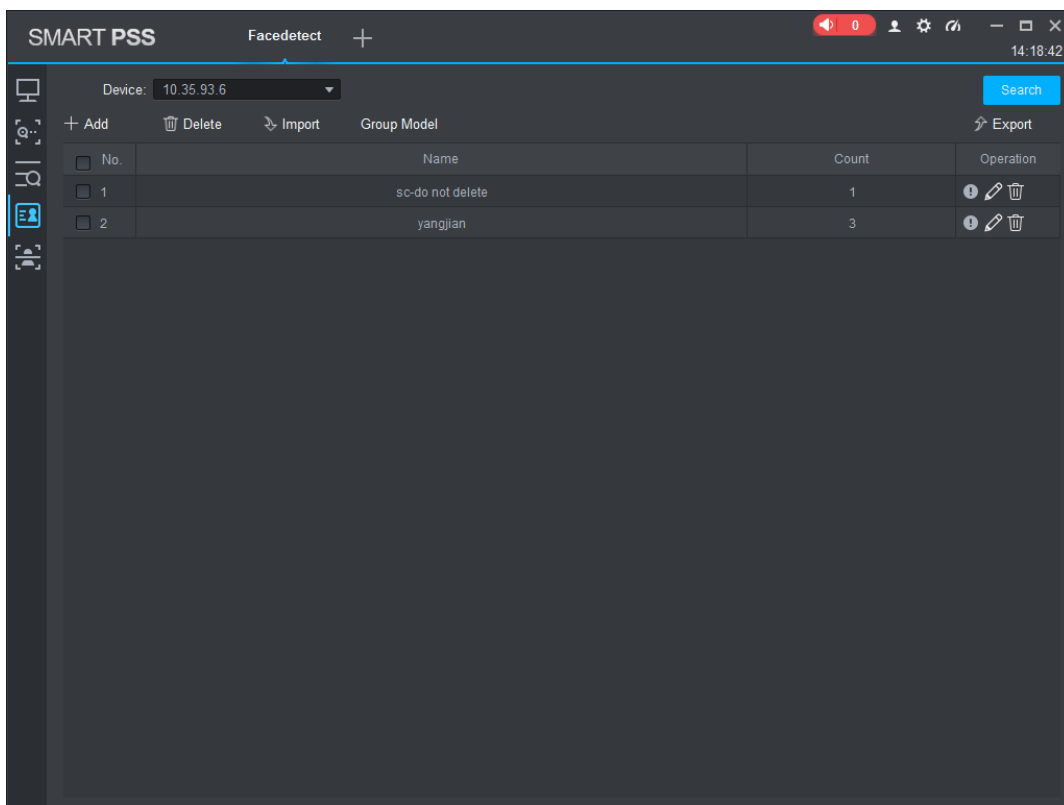

Figure 18-2

Step 3

Click **Add**.

The **Add Face Library** interface is displayed. See Figure 18-3.

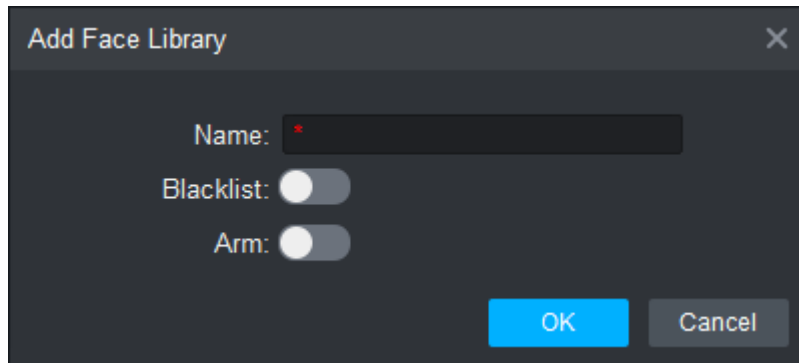

Figure 18-3

Step 4

Enter a name for the added library to **Name**. To enable blacklist alarms, toggle on **Blacklist**. To arm the library, toggle on **Arm**, set up the similarity threshold, and click **OK**.

18.1.1.2 Deleting Face Library

- Single Delete

Step 1

In the **Face Library Management** interface, click  next to a face library.

The system prompts Are you sure to delete face library? See Figure 18-4.

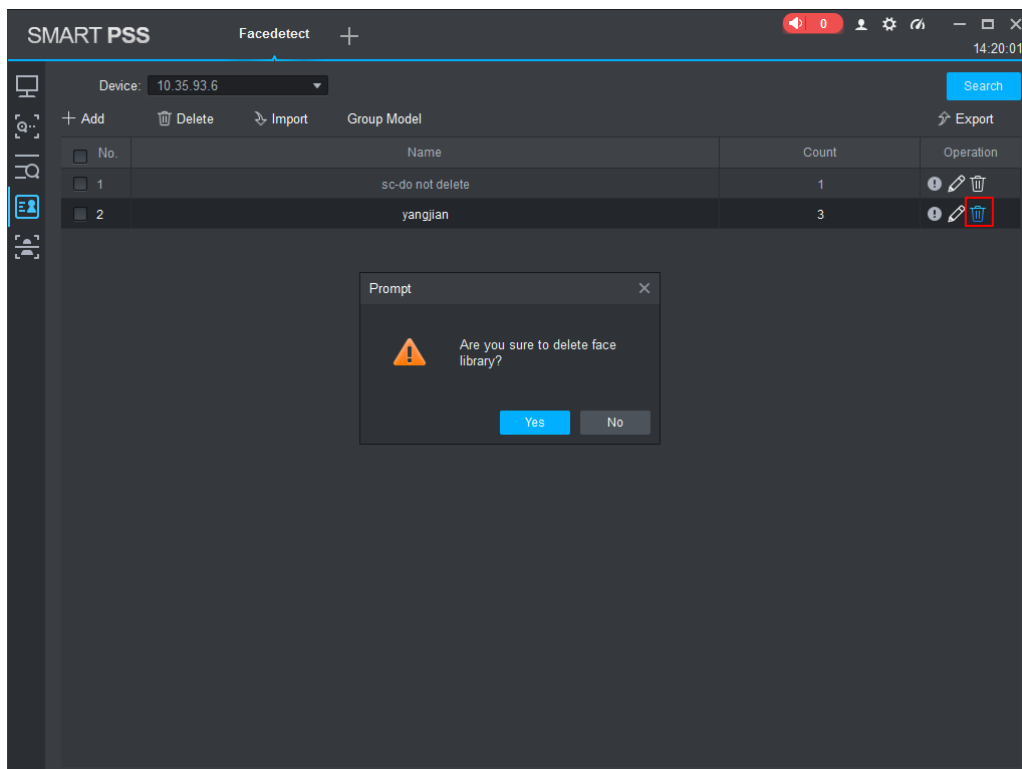

Figure 18-4

Step 2

Click **Yes** to delete the selected library.

- Batch delete

Step 3

In the **Face Library Management** interface, select a number of face libraries, and click **Delete** in the upper area of the interface.

The system prompts **Are you sure to delete selected face library?** See Figure 18-5

TIPS

Selecting **No.** can quickly select all face libraries.

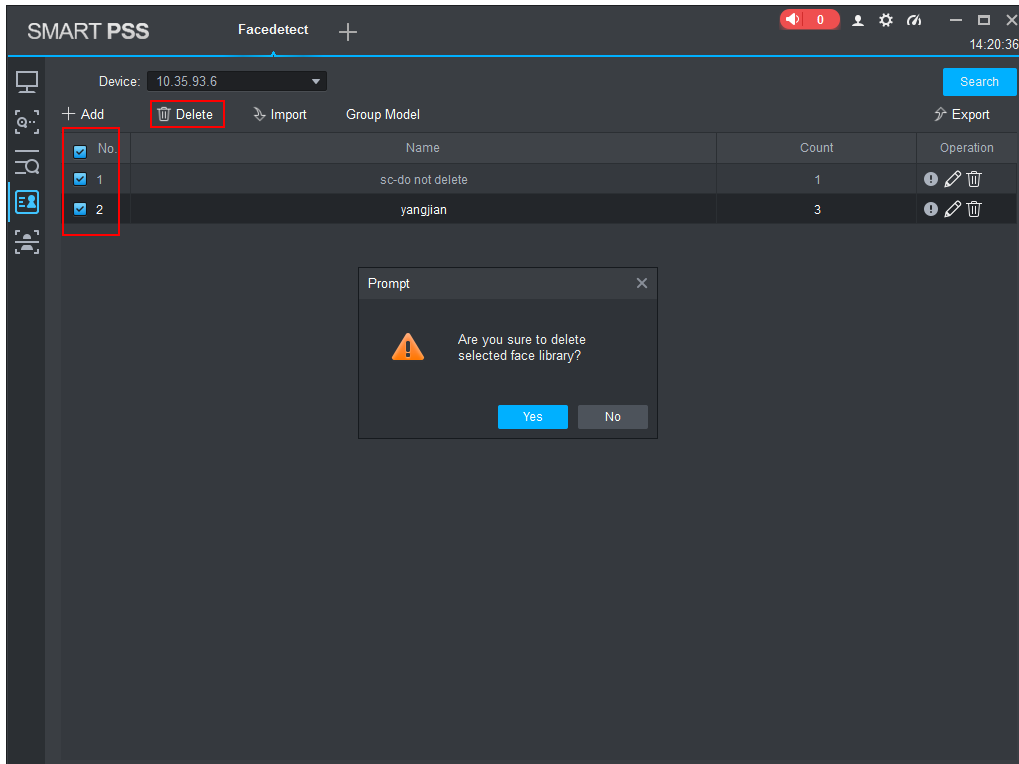

Figure 18-5

Step 4

Click **Yes** to delete the selected libraries.

18.1.1.3 Editing Face Library

This function lets you modify the name of a face library, toggle on/off blacklist, arm or disarm the library. With the library armed, you can modify the similarity threshold value.

Step 1

In the Face Library Management interface, click next to a face library.

The Edit Face Library interface is displayed. See Figure 18-6.

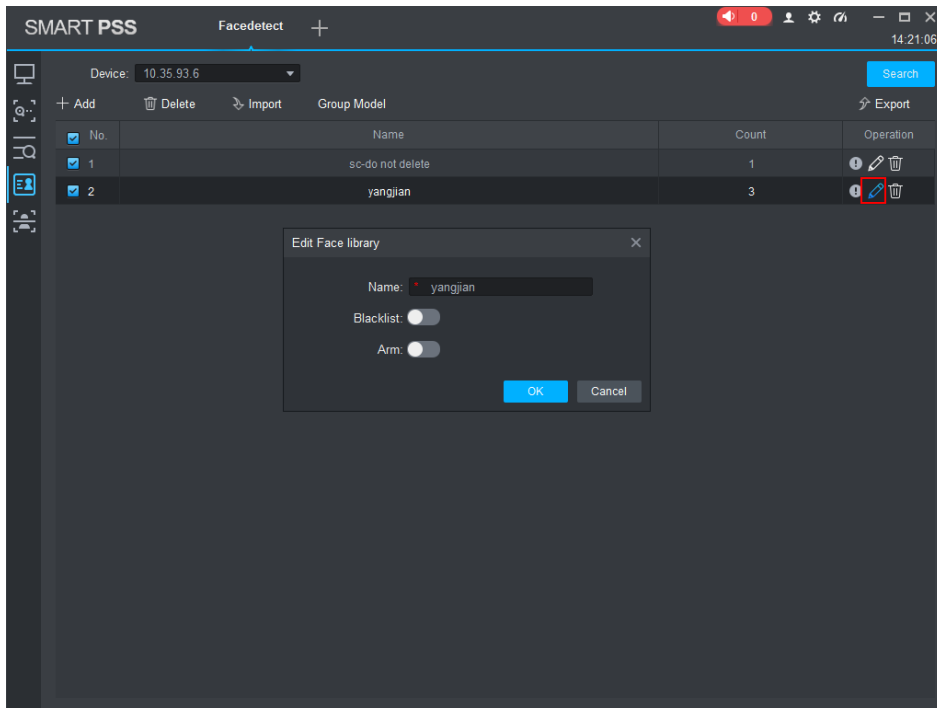

Figure 18-6

Step 2

Modify the face library information and click **OK**.

18.1.2 Person Management

If the information of persons (including face pictures) has been collected, the platform allows for adding this information of a single person or massive persons to the face library to prepare for arming.

18.1.2.1 Adding Person

18.1.2.1.1 Single Delete

In the **Face Library Management** interface, select Device and click Search.

The system displays information of existing face libraries. See Figure 18-7

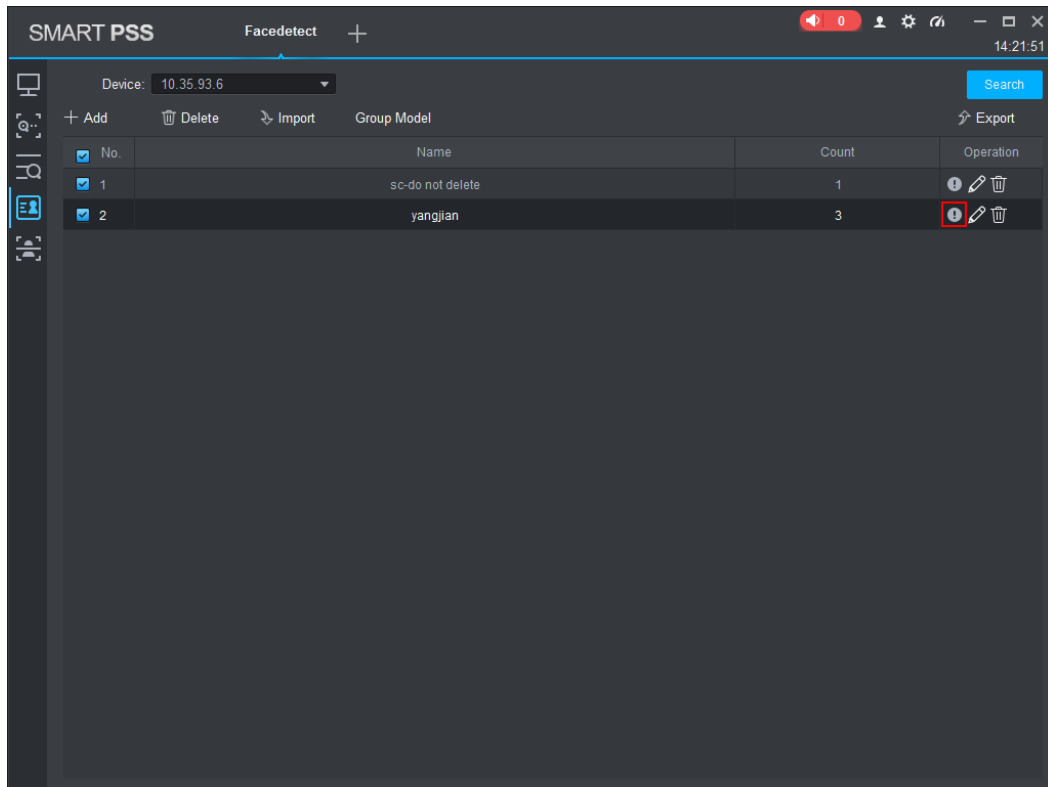

Figure 18-7

Step 2

Click [Warning] next to the face library.

The **Face Library Details** interface is displayed. See Figure 18-8.

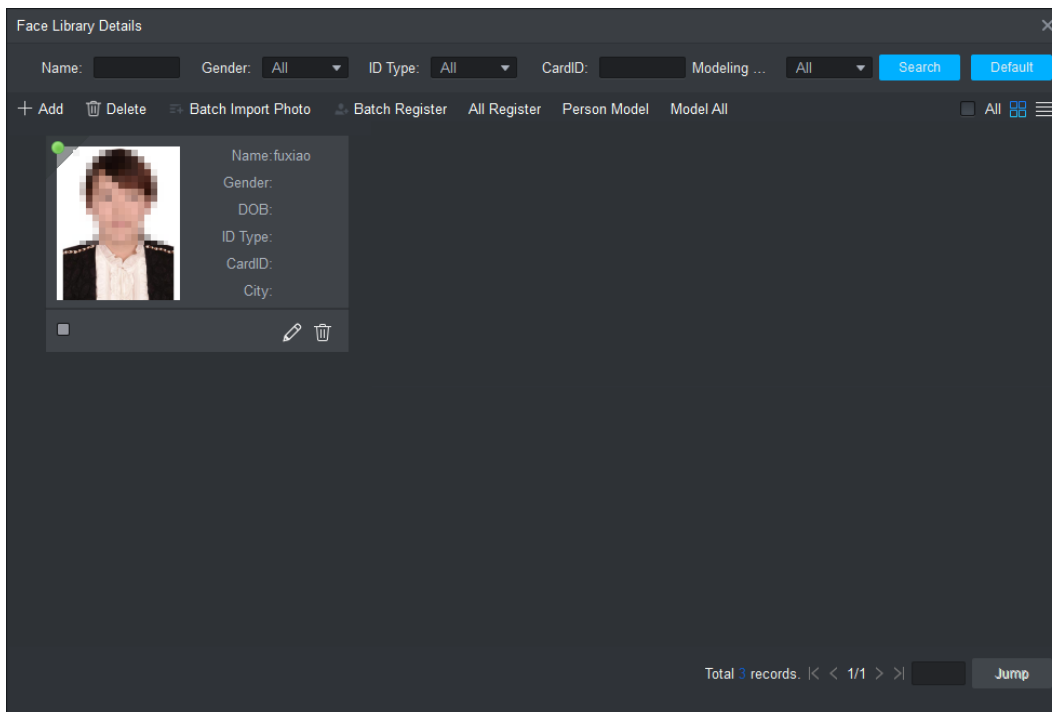

Figure 18-8

Step 3

Click Add.

The **Register Person Info** interface is displayed. See Figure 18-9.

Figure 18-9

Step 4

Follow on-screen instructions to upload face pictures, fill in person information, and Click **OK**.

The face library then displays the added information.

 NOTE

- Upload face pictures in jpeg or jpg only.
- To use the face recognition-based attendance system, make sure the No. of an added person is the same as that. of this person under the personnel management module.

18.1.2.1.2 Batch Add

 NOTE

Pictures of batch added persons in jpeg or jpg format must be stored in the same folder. Requirements on naming pictures are displayed in Figure 18-10. Import the picture naming fields as the information of related persons.

Name format: name#S gender #B DOB #N nation #P province #C city #T type #M ID
 Gender: 1. male 2. female; ID type: 1. ID 2. passport
 Province format: Zhejiang

Figure 18-10

Step 1

In the **Face Library Management** interface, select Device and click Search.

The system displays information of existing face libraries. See Figure 18-11.

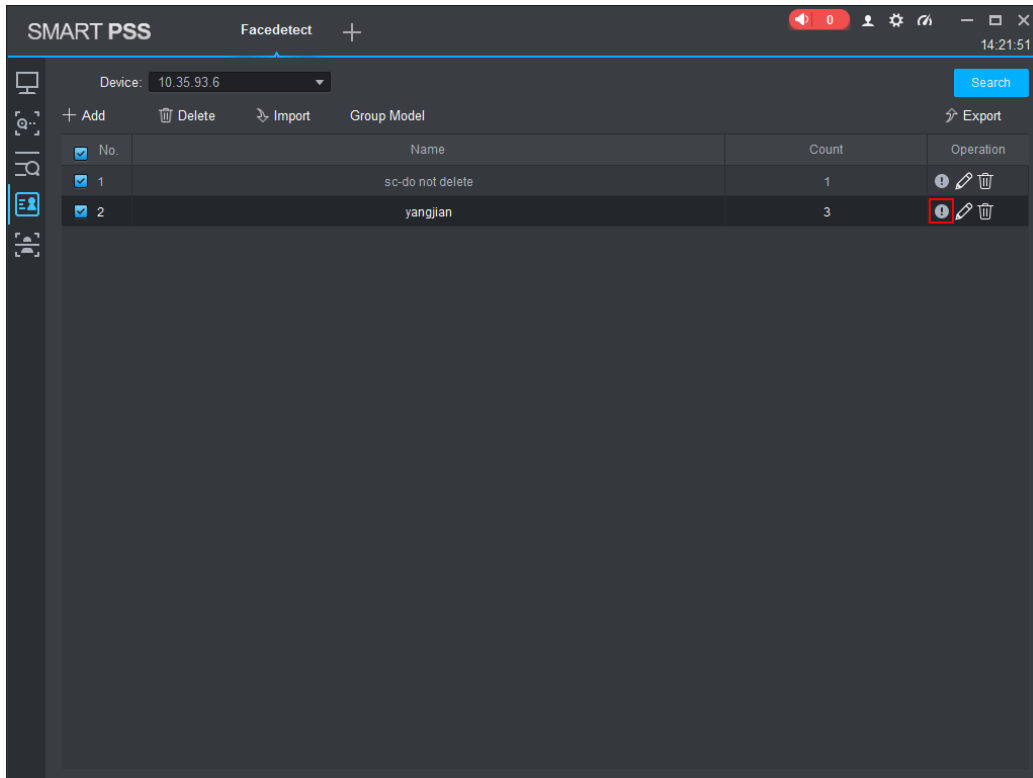



Figure 18-11

Step 2

Click  next to the face library.

The **Face Library Details** interface is displayed. See Figure 18-12.

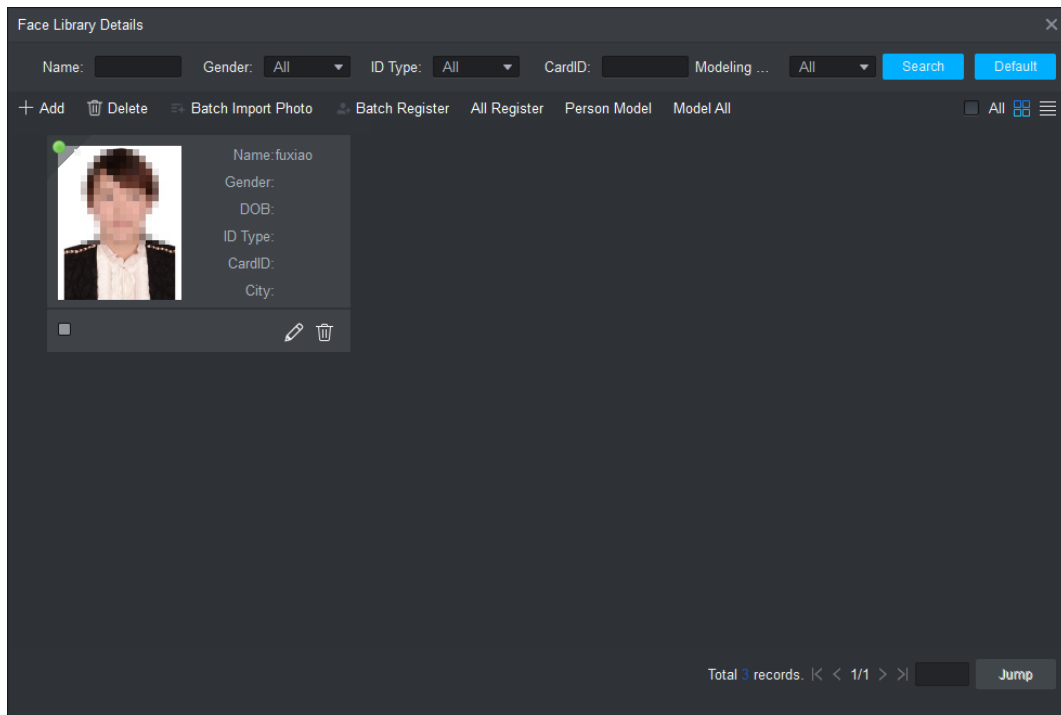

Figure 18-12

Step 3

Click **Batch Import Pictures**.

The **Batch Import** interface is displayed. See Figure 18-13.

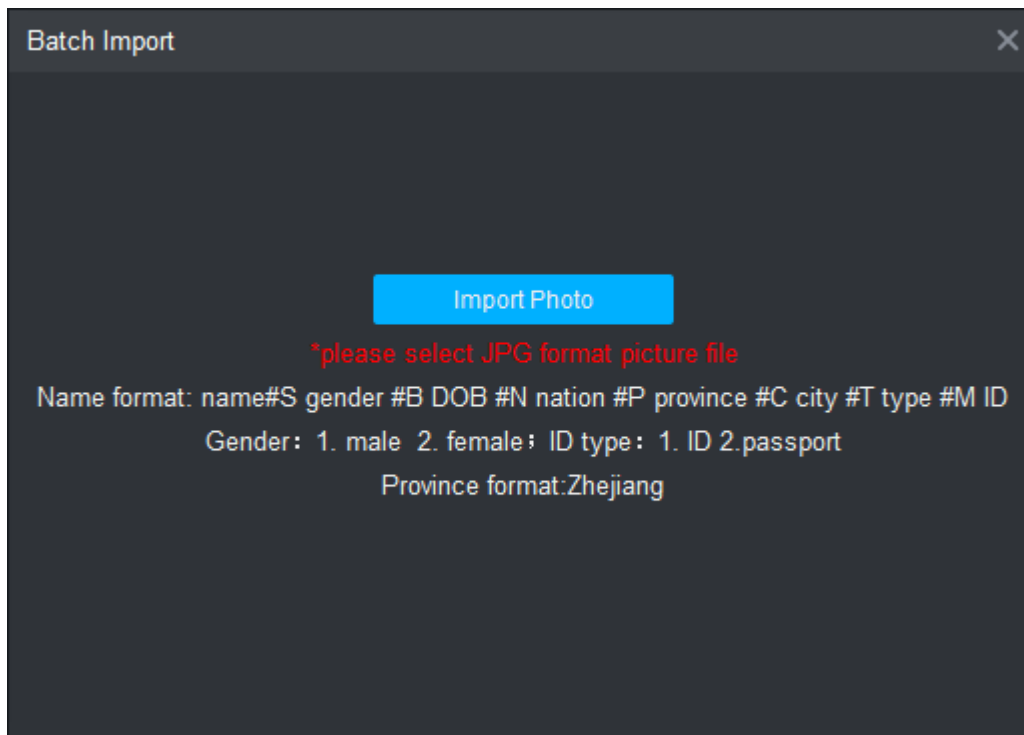

Figure 18-13

Step 4

Click **Import** to select the folder.

The system displays information of imported persons. See Figure 18-14. If the imported pictures are named according to the established rules, the system auto recognizes information of the persons, such as information of persons on the left in Figure 18-14. Otherwise, the information of persons is null.

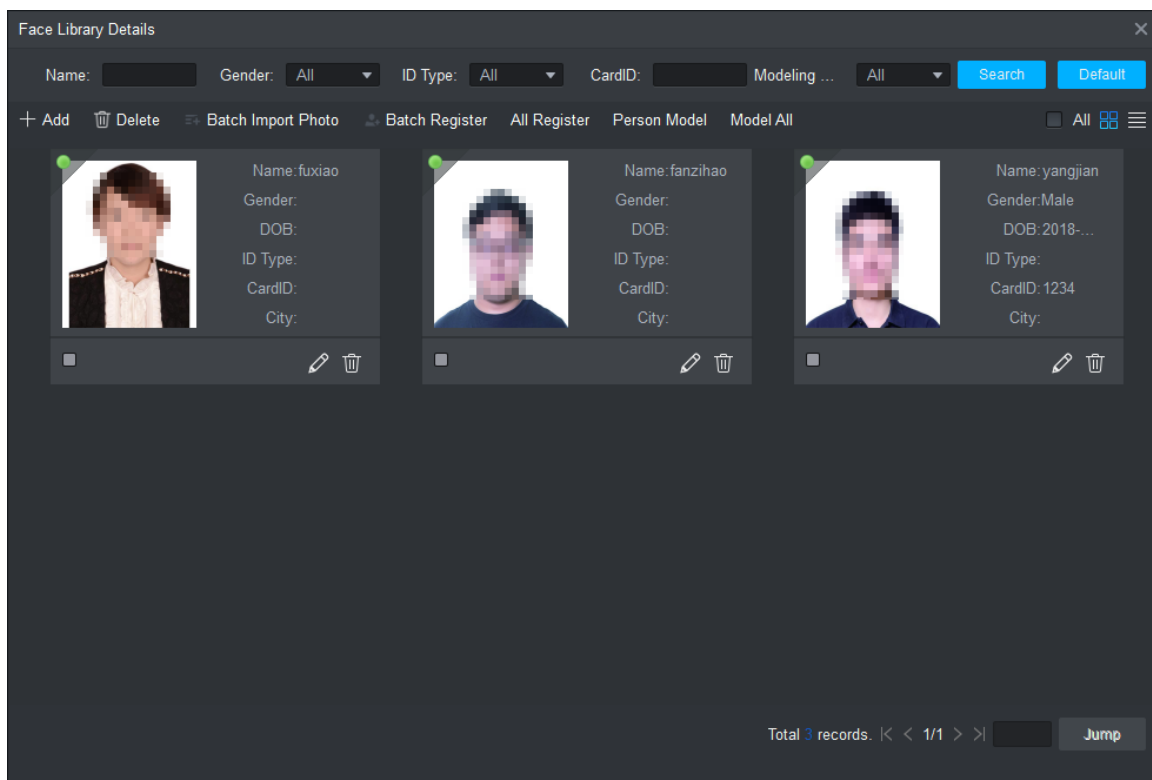

Figure 18-14

Step 5

Register persons.

- Batch register

Select persons to be registered, click **Batch Register** to complete registration.

- All Register

Click **All Register** and the registration progress, number of successful and failed registrations are displayed.

Step 6

Modeling

When the selected device is IVSS or face recognition camera, which has updated the algorithm, modeling is required. Otherwise, skip this step.

- Batch model persons in one library

In the **Face Library Details** interface, select target persons for modeling, click **Batch Model**, and the system displays the modeling progress.

- Model all persons in one library

In the **Face Library Details** interface, click **Model All**, and the system displays the modeling progress.

- Overall modeling of one or several libraries

In the **Face Library Management** interface, select **Device** and one or several face libraries, and the system displays the modeling progress.

18.1.2.2 Importing/Exporting Face Library Data

Importing/Exporting a face library allows for backing up the face library and information of persons in the library. This function can help quickly recover damaged data or quickly replicate data across different clients.

18.1.2.2.1 Exporting Face Library

Step 1

In the **Face Library Management** interface, select **Device** and a face library, and then click **Export**.

The **Face Library Export** interface is displayed. See Figure 18-15.

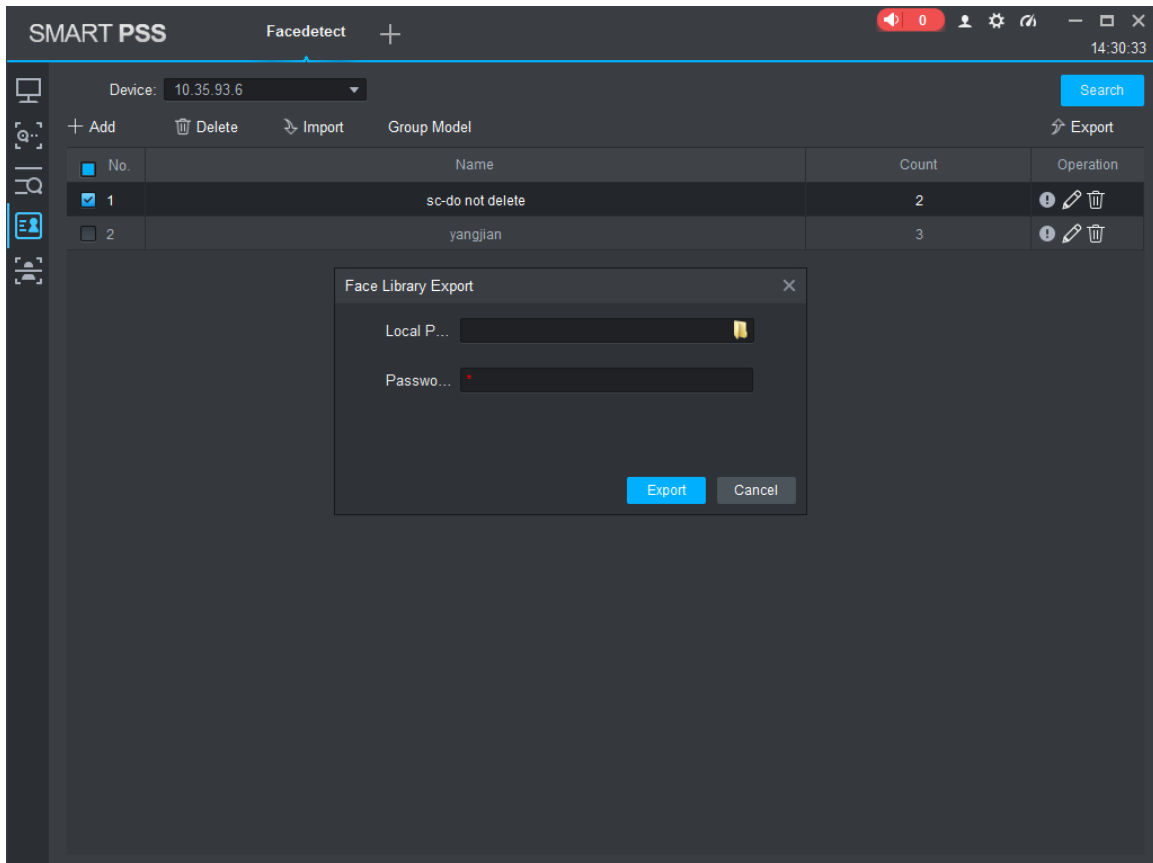

Figure 18-15

Step 2

Select the folder for exporting the bin file, set up the password for opening the exported bin file, and click **Export**.

The system displays the progress of the export.

Step 3

Click **OK**.

The system completes the export of face library data, and saves the exported file in the selected destination folder in the bin format.

18.1.2.2.2 Importing Face Library

Step 1

In the **Face Library Management** interface, select **Device** and click **Import**.

The **Face Library Import** interface is displayed. See Figure 18-16.

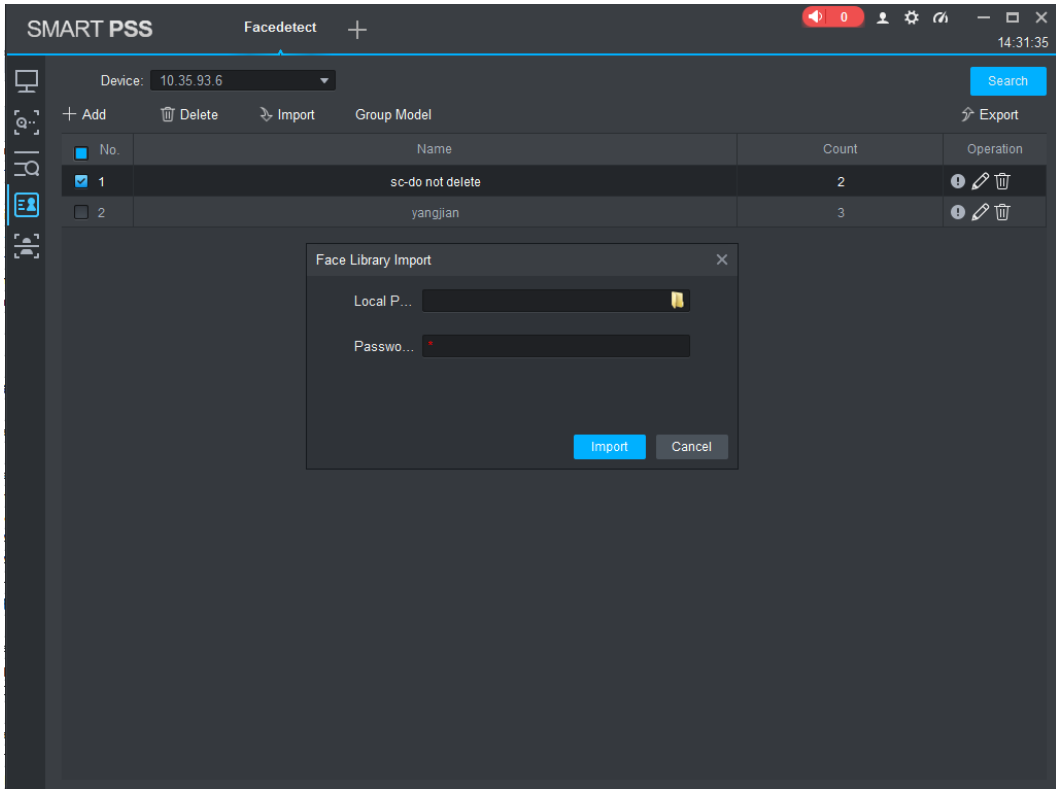

Figure 18-16

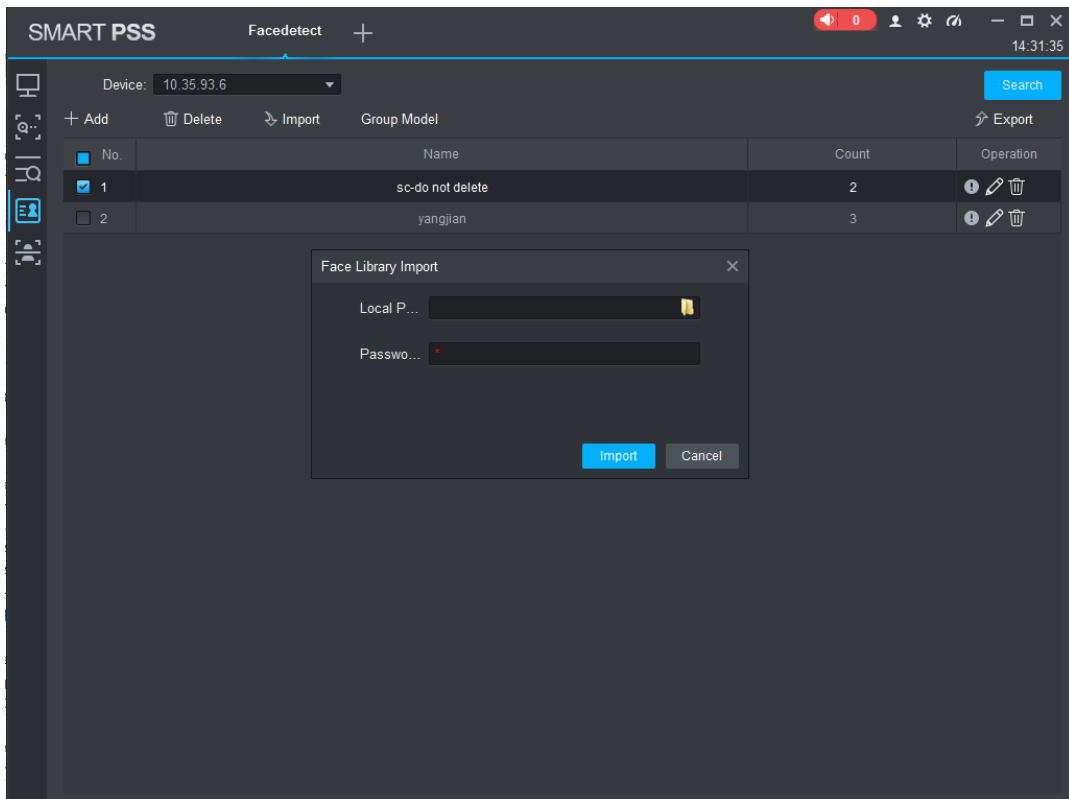

Figure 18-17

Step 2

Select the destination folder for storing the bin file, enter the password for opening the file, and click **Import**.

The system displays the progress of the import.

Step 3

Click **OK**.

The system completes importing the face library data, and the library is added to the corresponding device.

18.1.2.3 Modifying Person Information

Step 1

In the **Face Library Details** interface, click  in the entry of a person.

The **Register Person Info** interface is displayed. See Figure 18-18

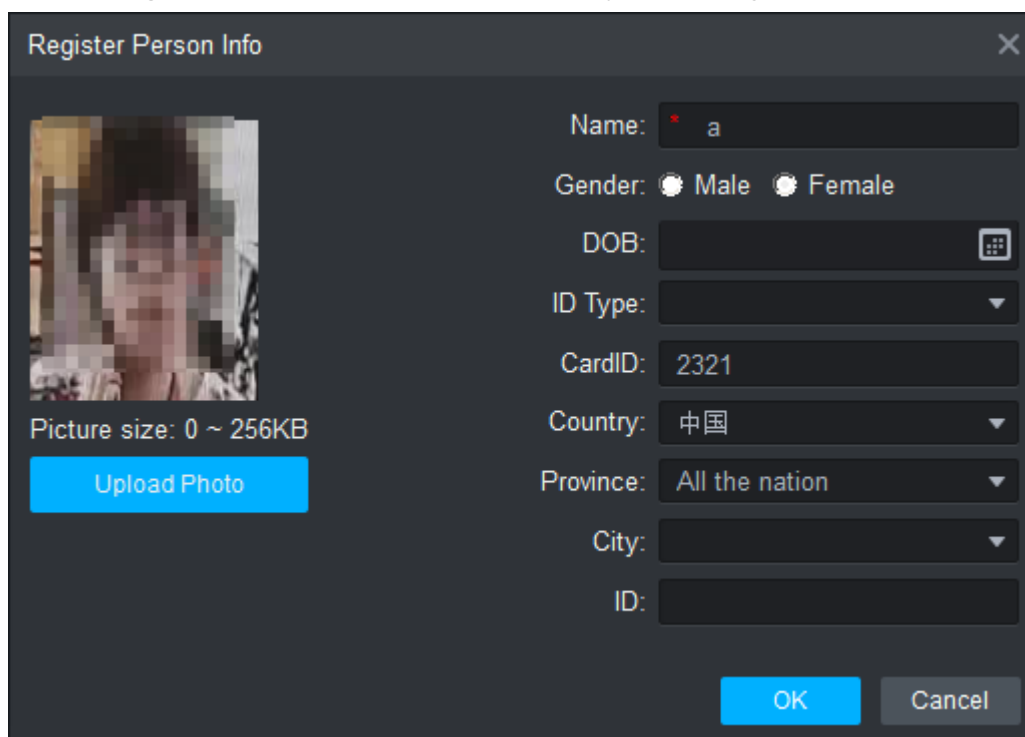

Figure 18-18

Step 2

Replace the face picture as needed, modify person information, and click **OK**.

18.1.2.4 Deleting Person

- Single delete

Step 1

In the **Face Library Details** interface, click  in the entry of a person.

The system prompts **Are you sure to delete the user?** See Figure 18-19.

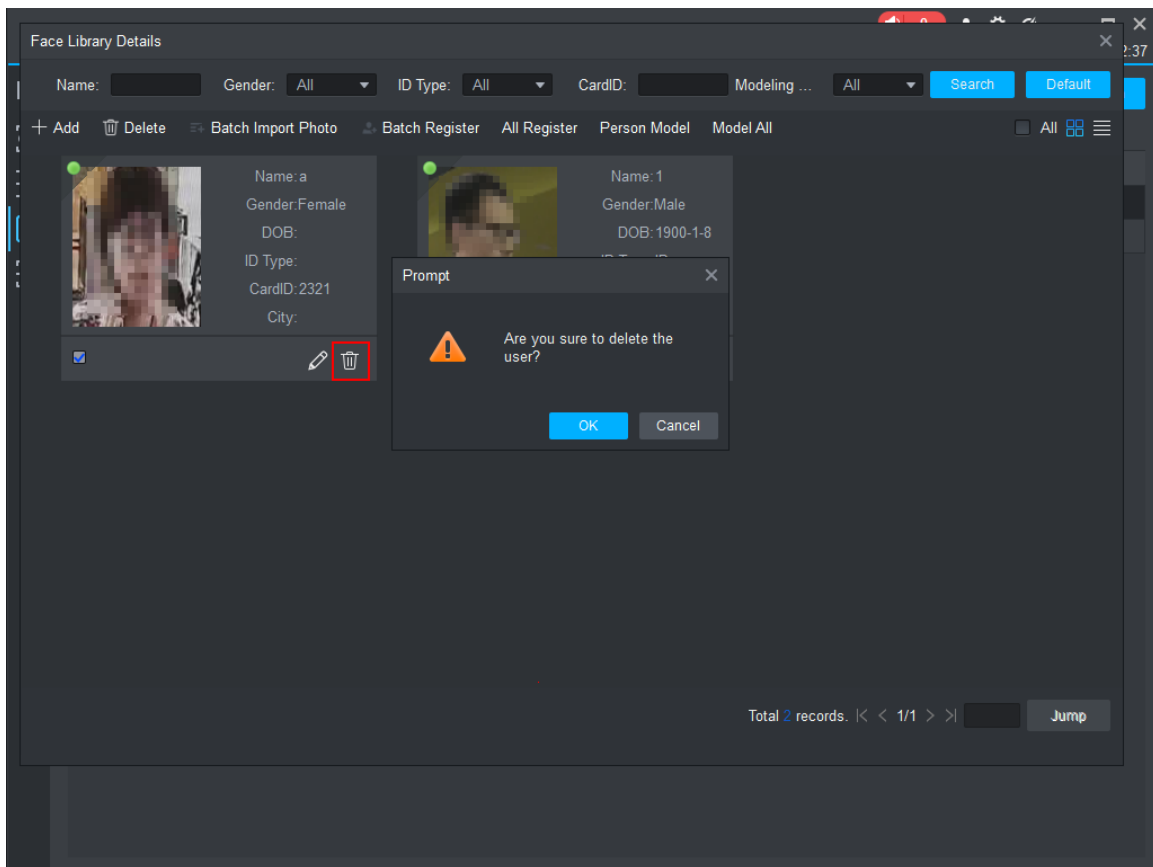

Figure 18-19

Step 2

To delete the user, click **OK**.

- Batch delete

Step 1

In the **Face Library Details** interface, select persons and click **Delete** in the upper part of the interface.

The system prompts **Are you sure to delete selected person info?** See Figure 18-20

TIPS

To delete all persons, select **All** at the upper right corner and click **Delete**.

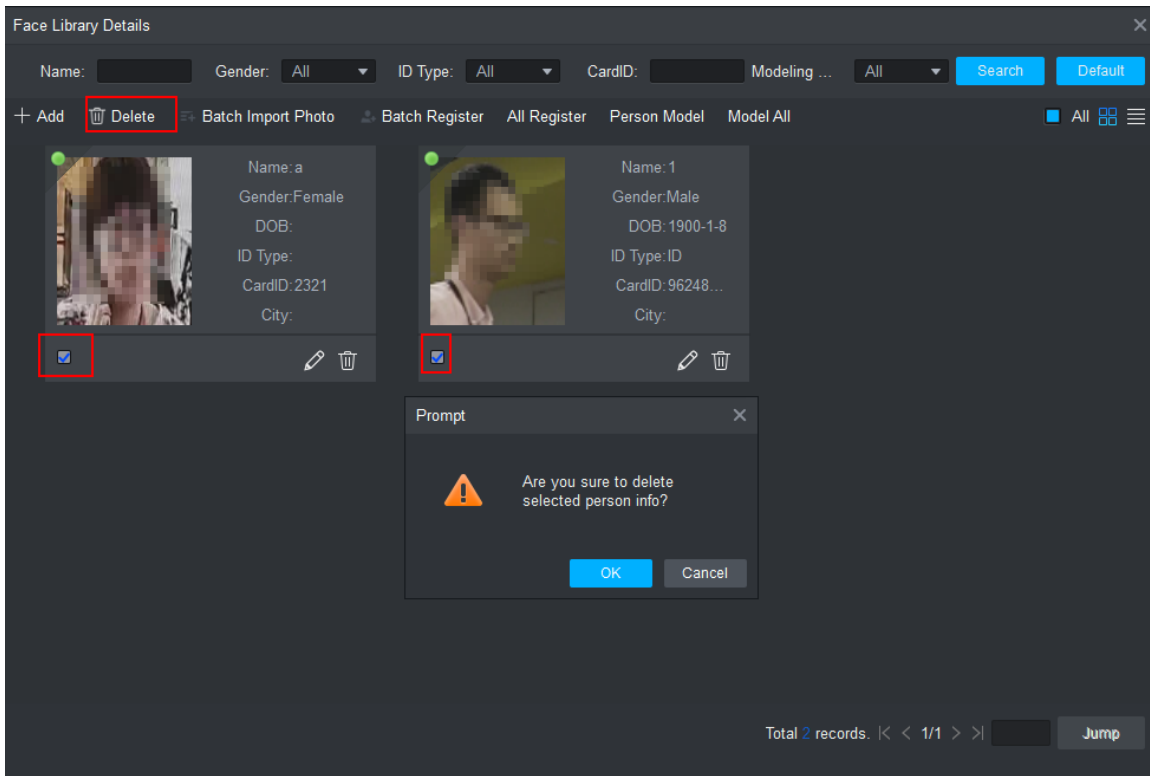

Figure 18-20

Step 2

Click **OK** to delete the selected users.

18.1.3 Arming Face Library

You can toggle on **Arm**, and then modify the similarity threshold value.

Step 1

In the **Face Library Management** interface, click  next to a face library.

The **Edit Face Library** interface is displayed. See Figure 18-21.

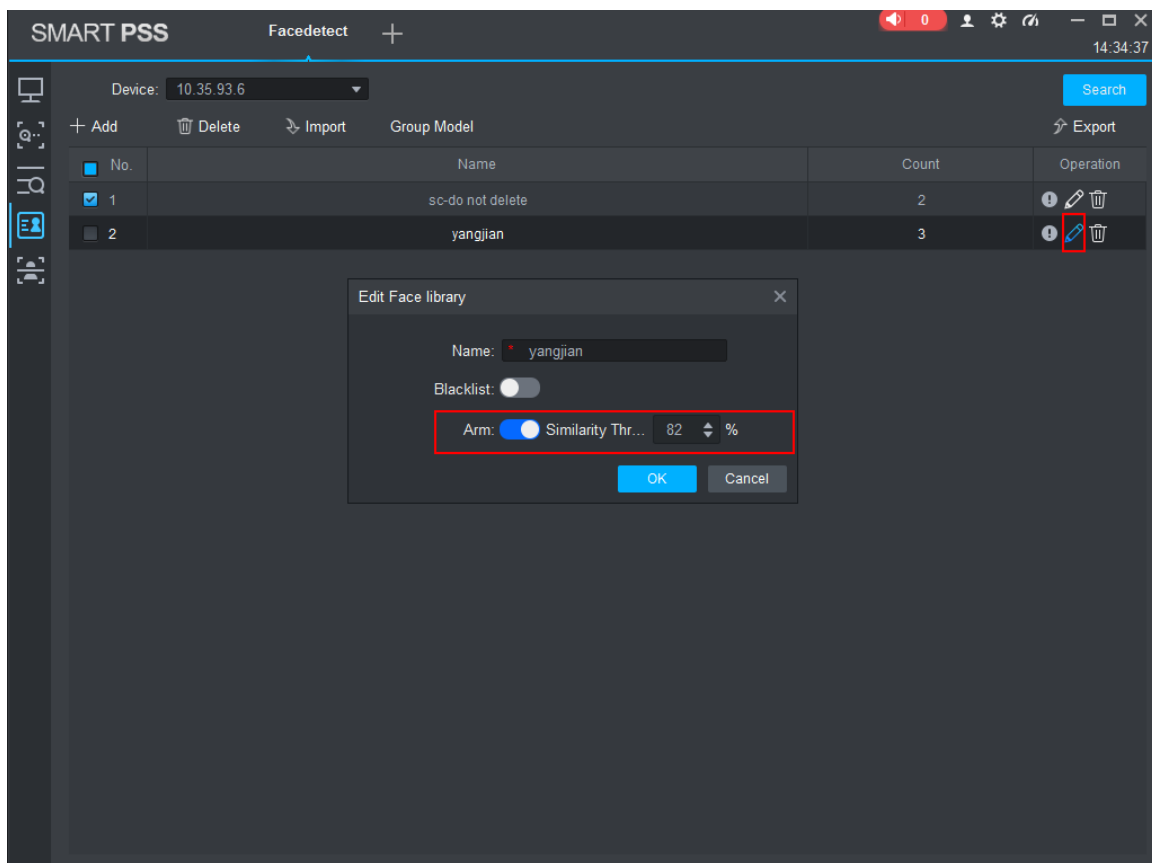

Figure 18-21

Step 2

Toggle on **Arm**, set up the similarity threshold, and click **OK**.

18.1.4 Face Collection

Connect to an integrated person-certificate machine and collect the face information detected by the machine. The collected face information can be distributed to different departments for recording attendance.

Step 1

Click .

The **Face Collection** interface is displayed. See Figure 18-22.

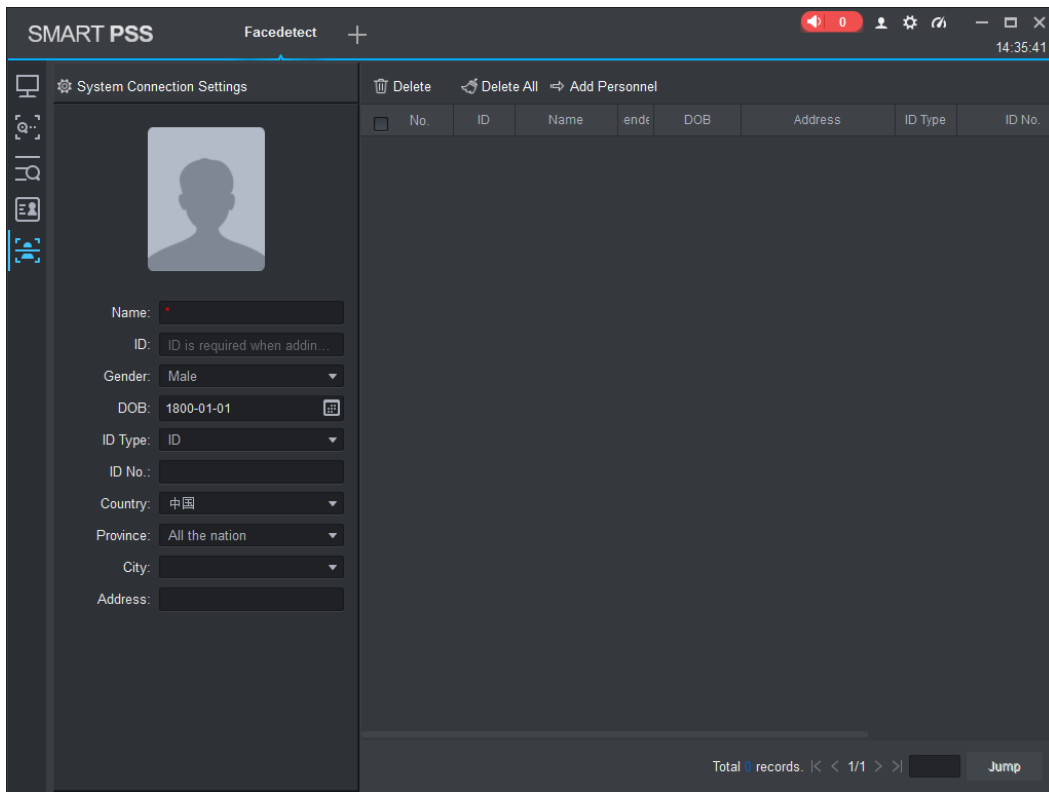

Figure 18-22

Step 2

Click **System Connection Settings** at the upper left corner.

The **ID Verification Connection Set (ID Verification Offline)** interface is displayed. See Figure 18-23.

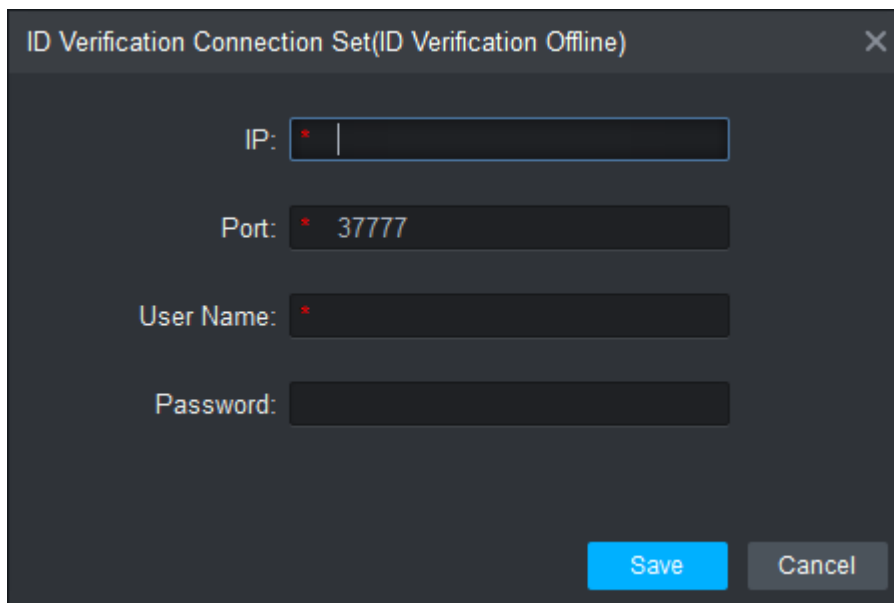

Figure 18-23

Step 3

Enter the IP, port number, username, and password of the integrated person-certificate machine, and click **Save**.

After saving, the system gives a prompt on whether the connection is successful. After a successful connection, if swiping the card on the machine, Smart PSS automatically

obtains and saves the information read from the machine, including the picture and ID number.

18.2 Face Recognition Applications

Face recognition applications at the client include:

- Video preview

In the real-time preview interface, you can review videos in real time, take snapshots, and compare results. You can also review person snapshots and comparison details.

- Snapshot query

Search for matching persons in the face library or snapshot results by characteristics information or face pictures.

- Recognition query

Search for faces that match the preset characteristics information from face comparison results.

18.2.1 Video Preview

Step 1

In the Face Recognition interface, click .

The system displays the **Preview** interface.

Step 2

Click  to unfold the device list. See Figure 18-24.

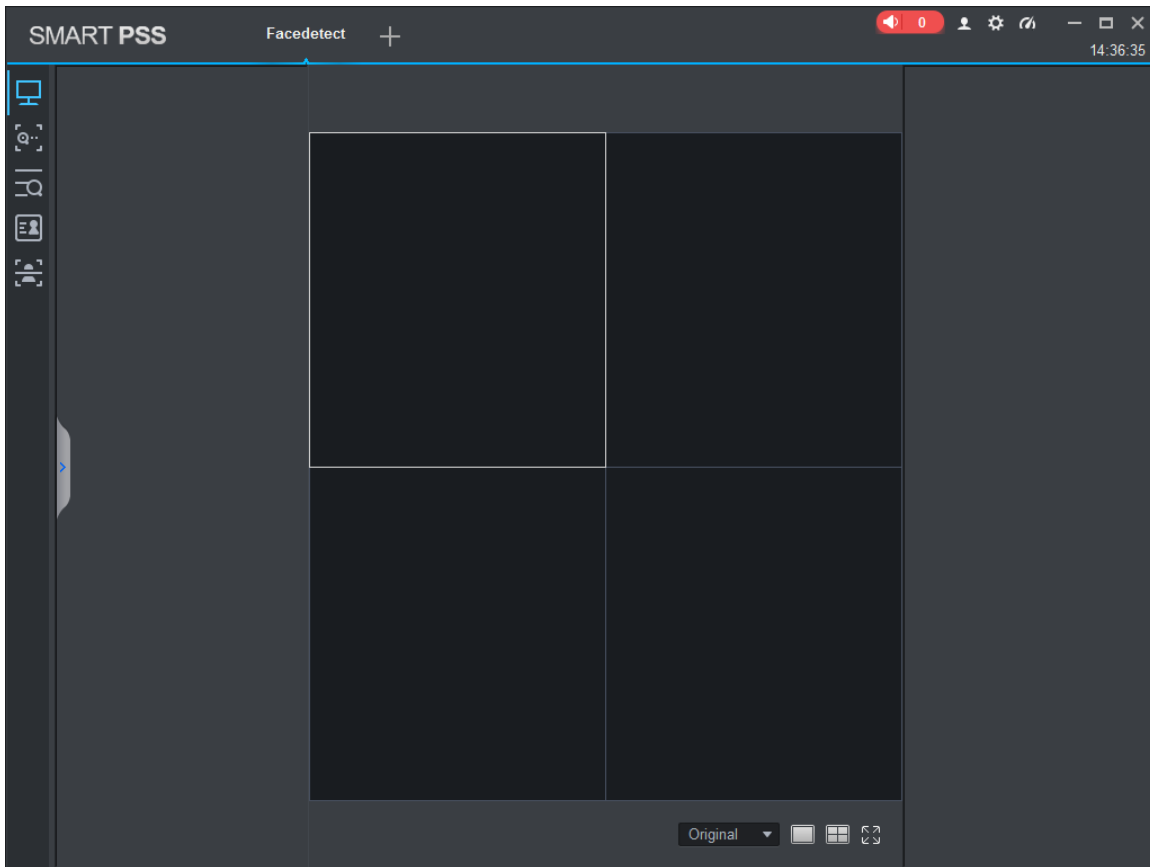



Figure 18-24

Step 3

Start real-time monitoring. See Figure 18-25.

- Select the monitor window, and double-click the channel from the channel list on the left to start real-time monitor.
- Drag the channel in the device list on the left to the monitor window.
- Right-click the device channel and select Preview to start real-time monitoring on the channel.

NOTE

Figure 20-28 displays the interface of the closed device list after clicking .

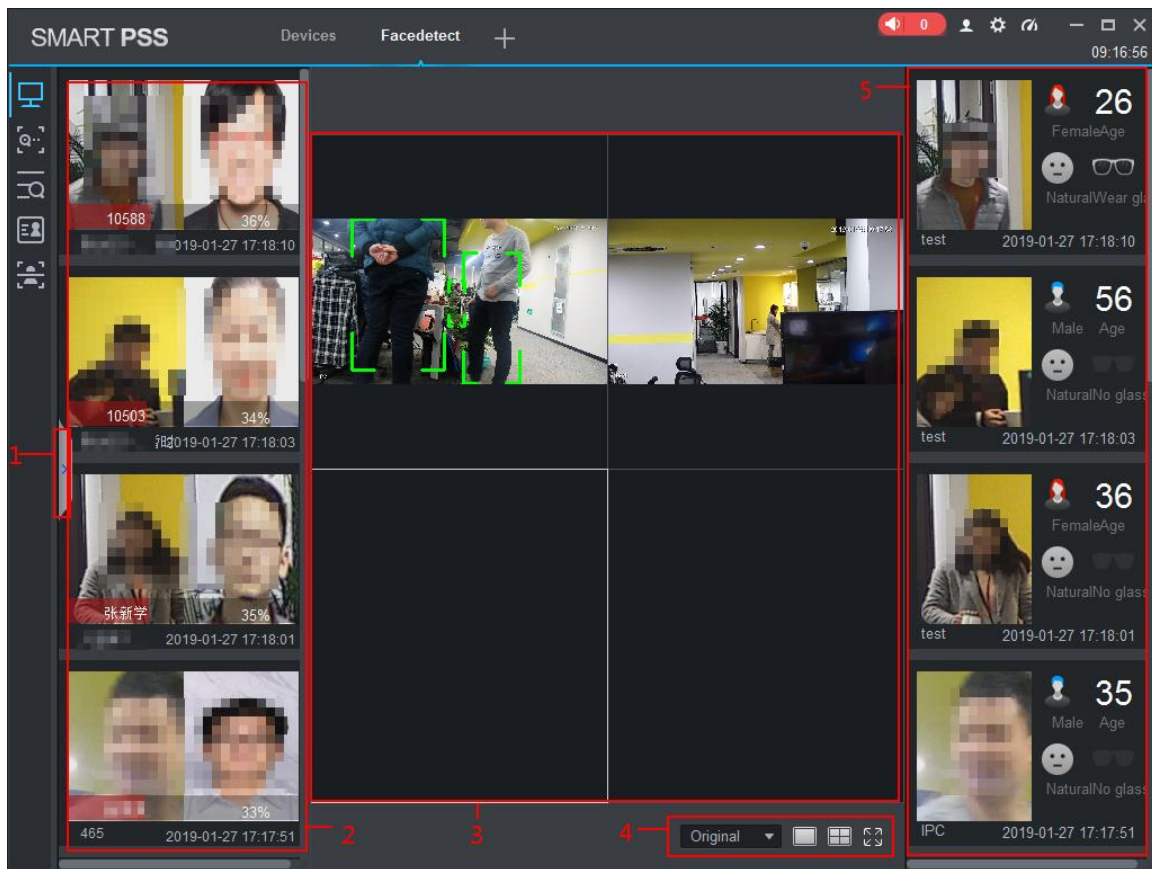





Figure 18-25

No.	Name	Description
1	Device list unfolding icon	Click this icon to display information of the device and its channels.
2	Comparison results display	Displays comparison results. If the device list has unfolded, click  to show the comparison results display area. Double-click the comparison results to check for details, including partial cut-out pictures or panorama, to compare against face pictures and person information in the face libraries.
3	Real-time review image	Displays the real-time video area.
4	 Video display ratio	Provides multiple options of video display ratio, such as full screen and original ratio.
	 Number of windows	Allows for switching between a single window and four windows.
	 Full screen display	Full screen display at the client.

No.	Name	Description
5	Face snapshots display area	Displays the captured face snapshots. Double-click a face snapshot to view details of the person in question, including partial cut-out pictures, panorama, and face attributes. If the face recognition device stores recorded videos at the time of capture, SmartPSS can play such videos.

Chart 18-1

18.2.2 Searching for Snapshots

You can search for matching persons from the snapshot results by characteristics information or face pictures.

18.2.2.1 Search by Images



If the face recognition device does not support this function, SmartPSS cannot search by images.

Step 1

In the Face Recognition interface, click .

The Snapshot Result Search interface is displayed. See Figure 18-26.

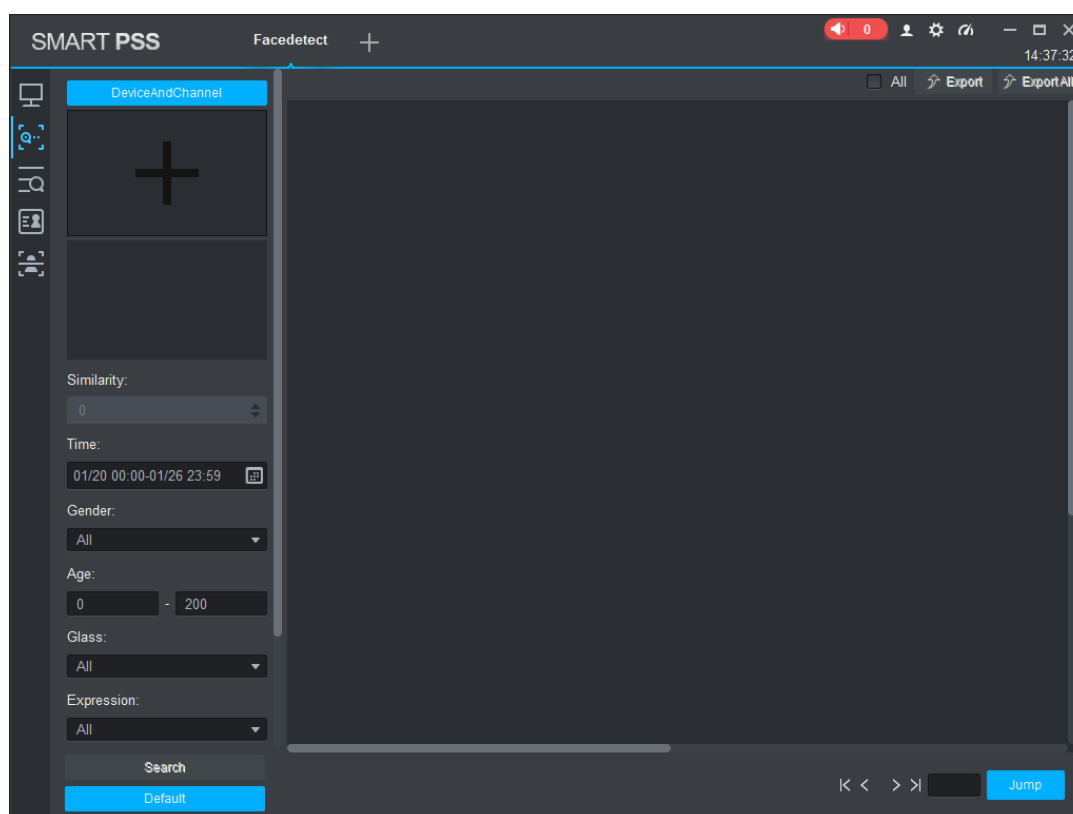

Figure 18-26

Step 2

Set up the search conditions. See Figure 18-27.

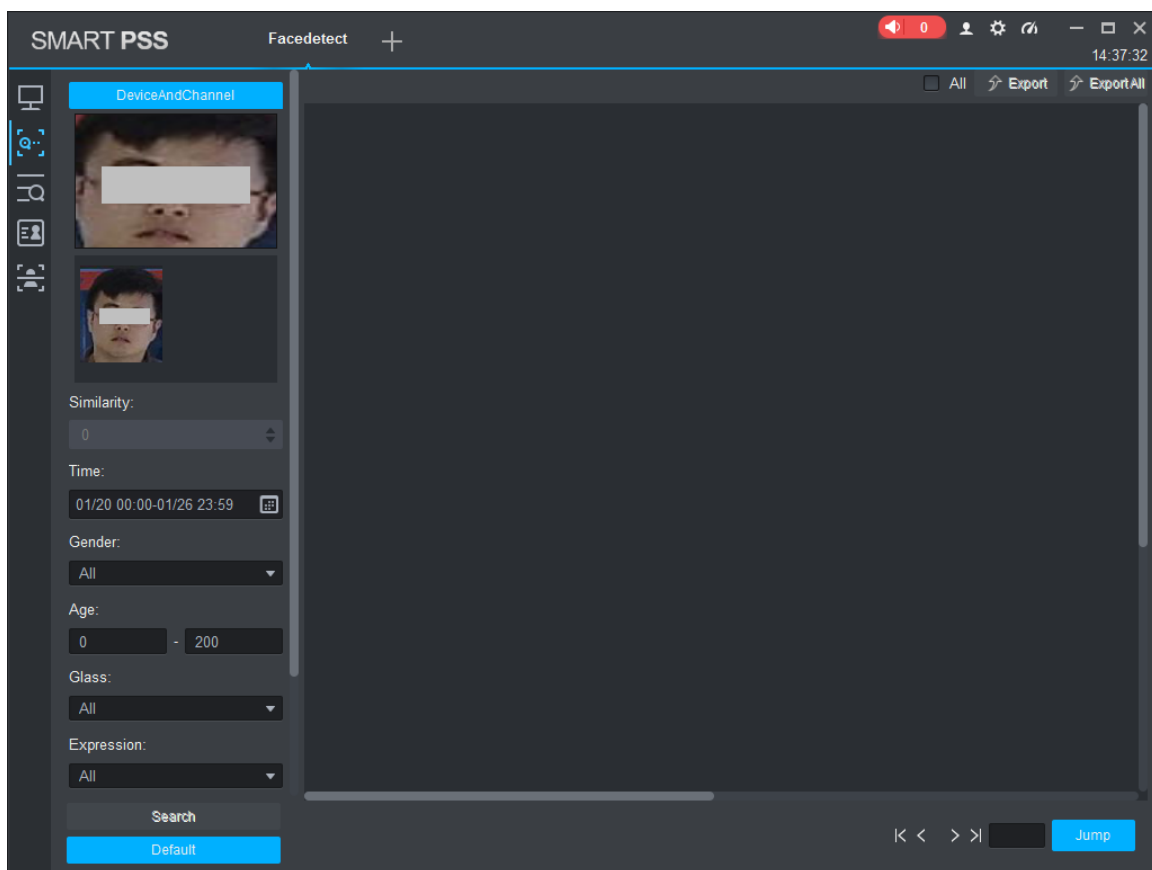



Figure 18-27

1. Select the Device and Channel. See Figure 18-28.

 **NOTE**

- The selected device must be compatible with the search-by-images function. These devices include IVSS and smart NVR. If the selected device does not support this function, the + sign in  is grayed out and cannot be used to add face pictures for searching for other pictures.
- You can select only one device, but multiple of its channels.

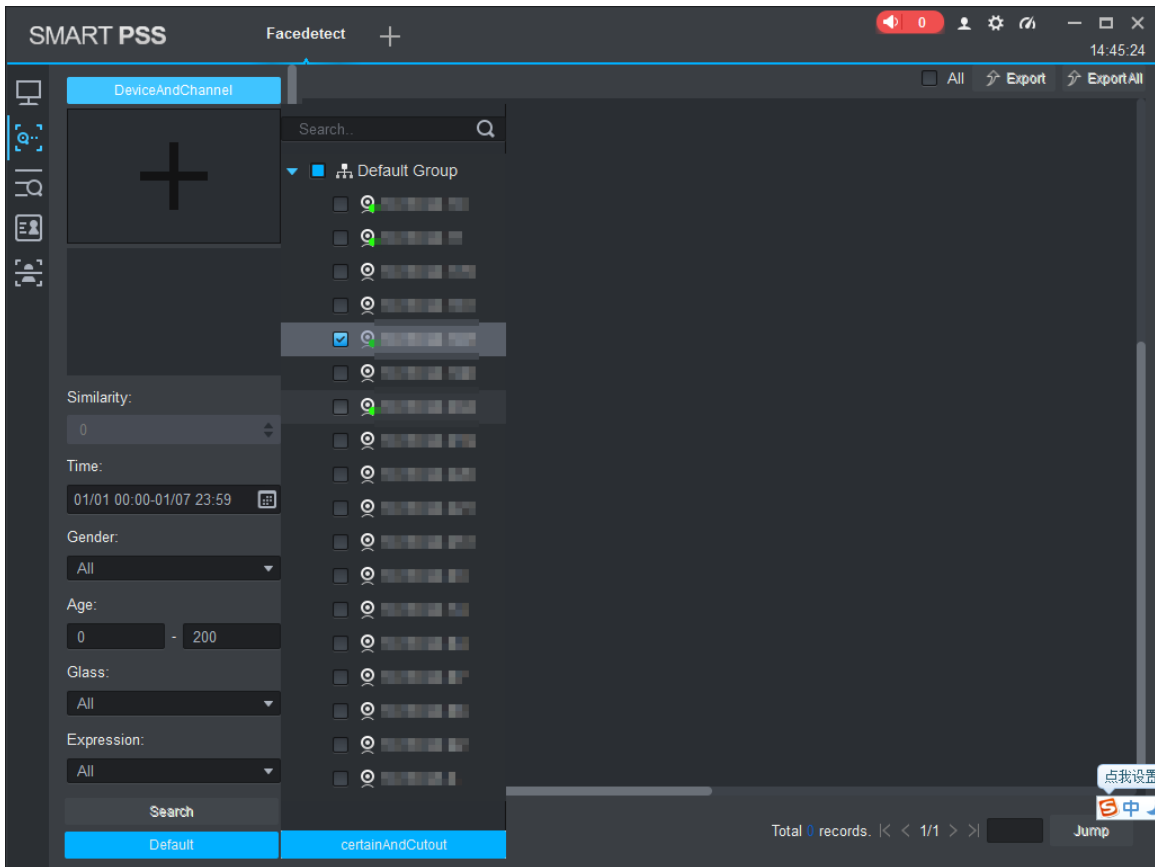

Figure 18-28

2. Click , and follow on-screen instructions to upload face pictures.
If a group picture of faces is uploaded, the system recognizes multiple faces in the picture. How well the system can do this relies on relevant face recognition devices.
3. Select the persons you want to search for. A selected person is circled with a blue box. See Figure 18-29.



Figure 18-29

4. Set up the **Similarity** and **Time**.

 **TIPS**

To quickly clear settings and search results, click **Default**.

Step 3

Click **Search**.

The system displays the search results.

Step 4

Double-click the search result.

The **Face Contrast Detail** interface is displayed. See Figure 18-30. In this interface,

you can view details of the person in question, including partial cut-out pictures, panorama, and face attributes. If the face recognition device stores recorded videos of the person, SmartPSS lets you review such videos.

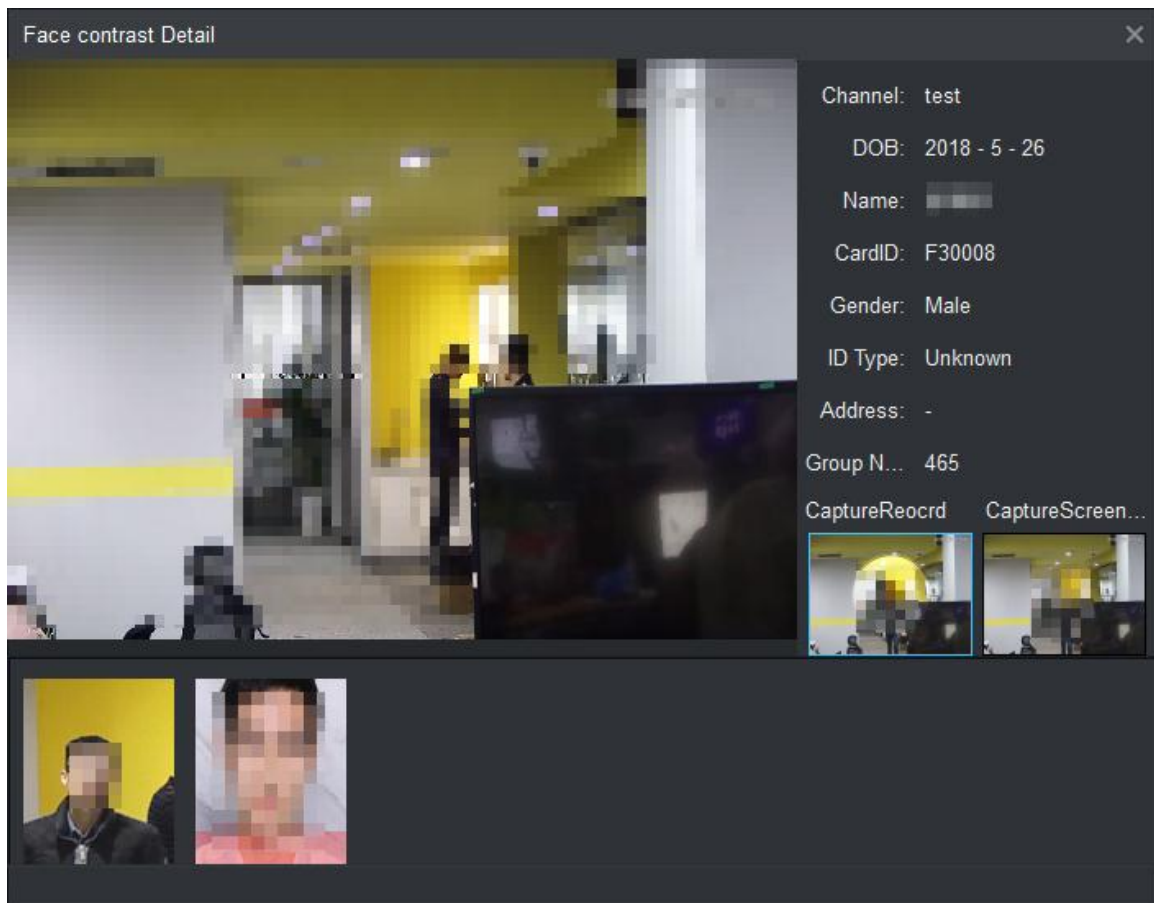

Figure 18-30

Step 5

Exporting search result.

- This function lets you export search results.

Select the exported search results, click Export, and follow on-screen instructions to locally save the results in the xls format.

TIPS

Clicking All can quickly select all search results in the current interface.

- Export all results

Click **Export All**, and follow on-screen instructions to locally save all results in the xls format.

18.2.2.2 Conditional Search

Step 1

In the Face Recognition interface, click .

The Snapshot Result Search interface is displayed. See Figure 18-31.

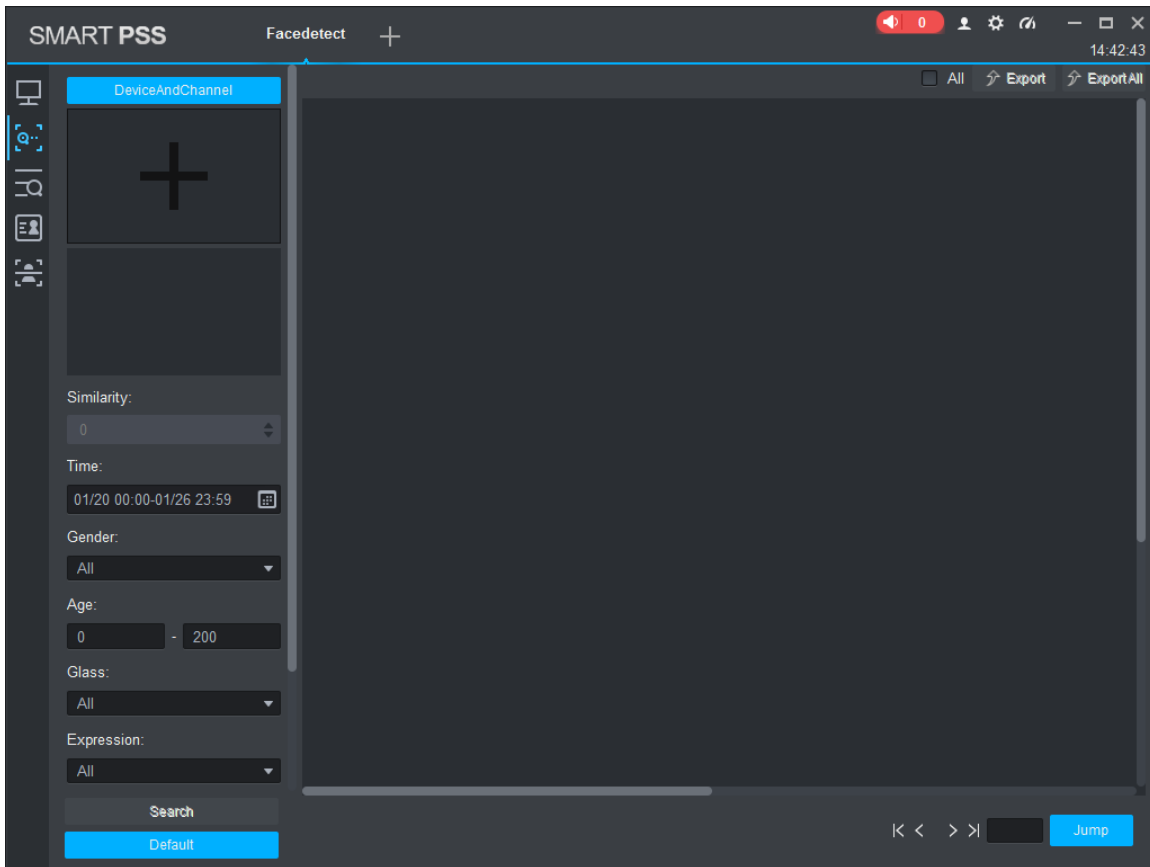



Figure 18-31

Step 2

Set up the search conditions.

1. Click Device and Channel to select Device and Channel. See Figure 18-32.

NOTE

- You can select only one device, but multiple of its channels.
- If the selected device does not support this function, the + sign in  is grayed out and cannot be used to add face pictures for searching for other pictures.

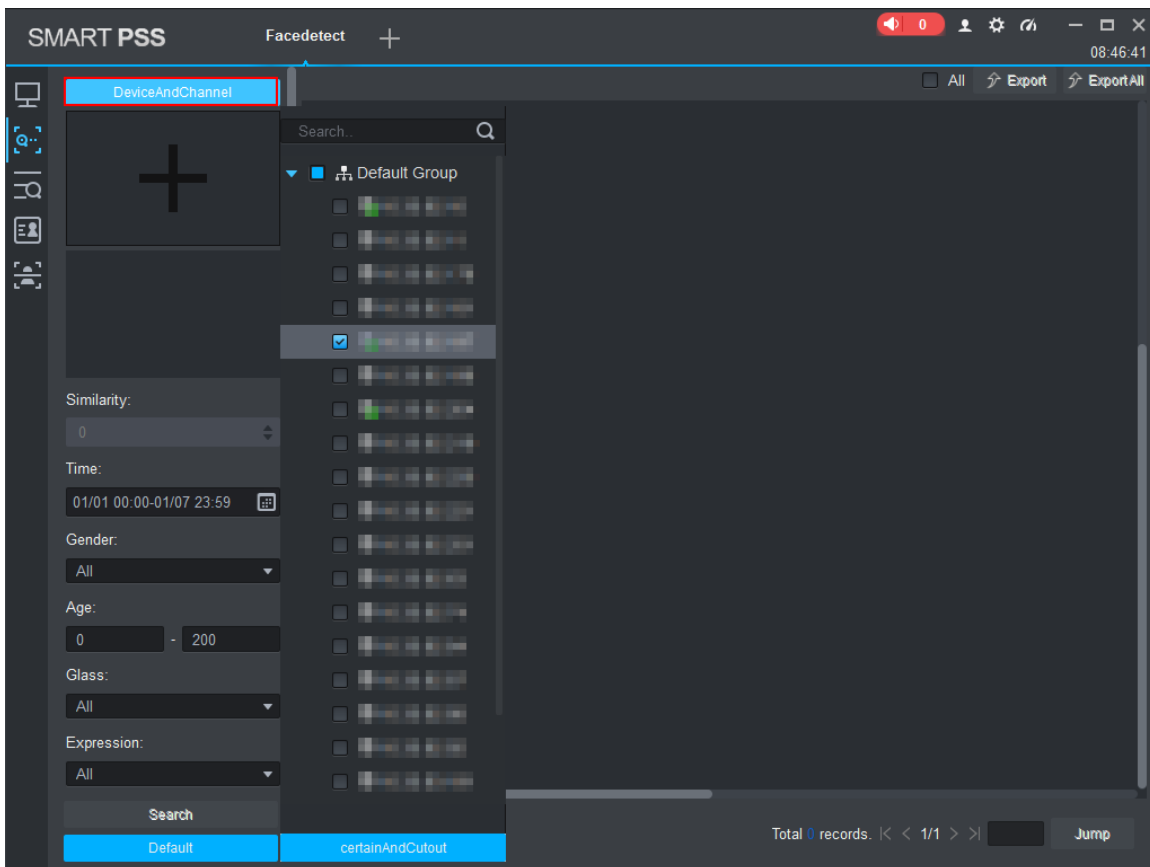

Figure 18-32

2. Set up Time, Gender, Age, and other conditions.

 TIPS

To quickly clear settings and search results, click Default.

Step 3

Click Search.

The system displays the search results. See Figure 18-33

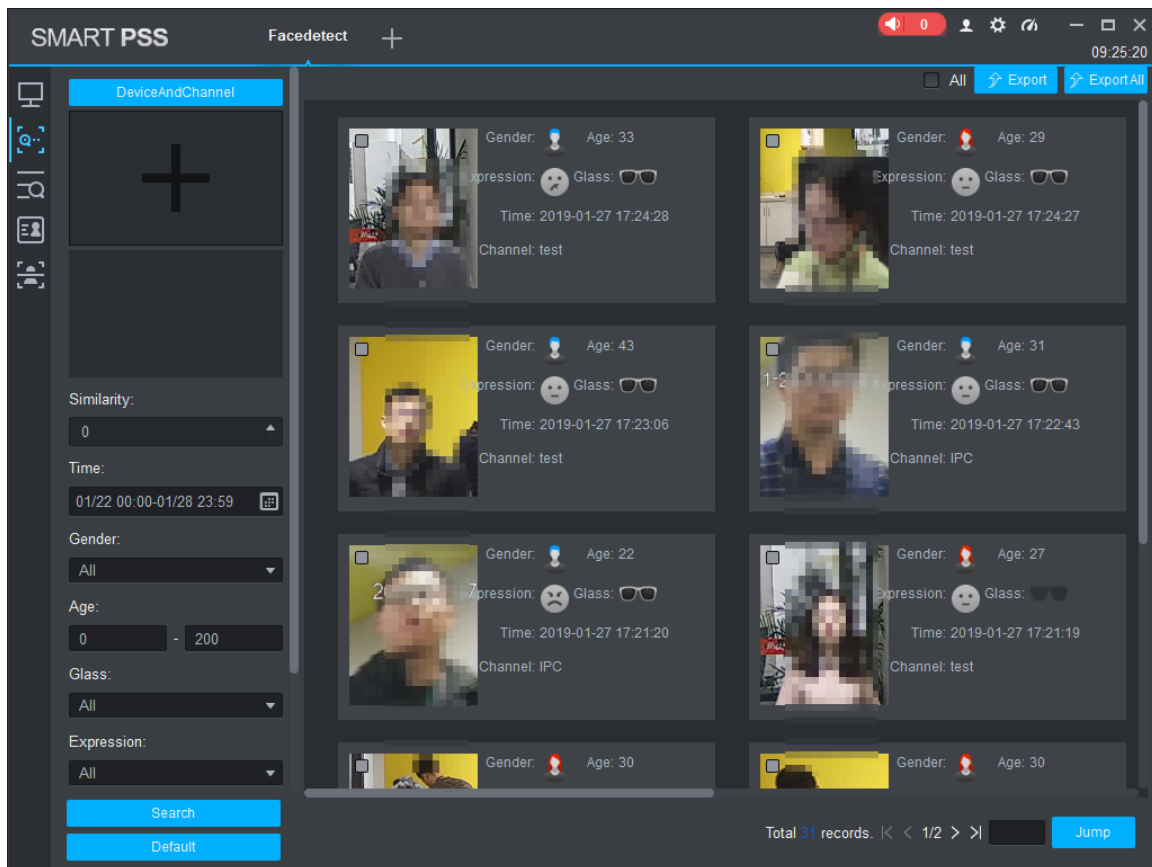

Figure 18-33

Step 4

Double-click the search results to review snapshot details. See Figure 18-34.

Get the associated videos on the right from the face recognition devices. If no videos are saved on the devices, SmartPSS cannot review these videos.

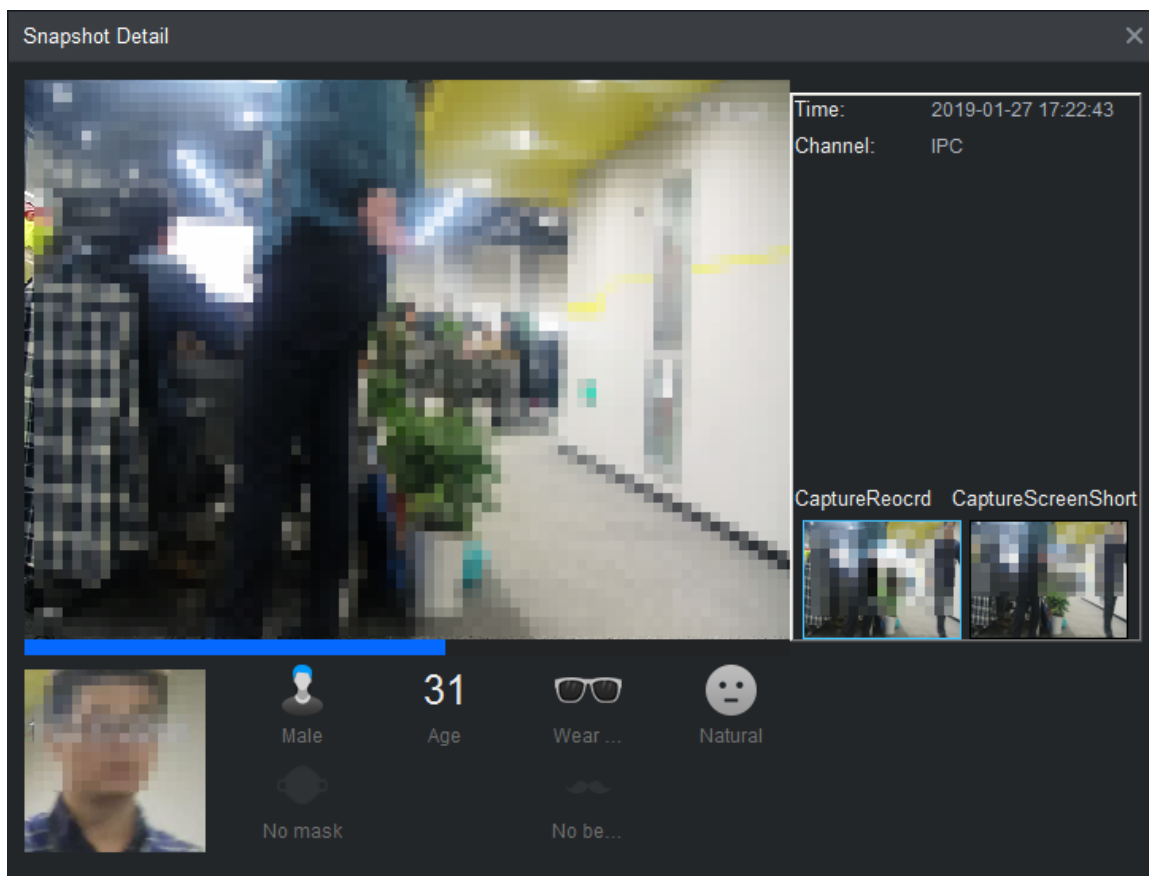

Figure 18-34

Step 5

Export search result.

- This function lets you export search results.

Select the exported search results, click **Export**, and follow on-screen instructions to locally save the results in the xls format.

🔑 TIPS

Clicking **All** can quickly select all search results in the current interface.

- Export all results

Click **Export All**, and follow on-screen instructions to locally save all results in the xls format.

18.2.3 Search Comparison Results

You can set up conditions and search for matching records in the comparison result.

Step 1

In the Face Recognition interface, click .

The Comparison Result Search interface is displayed. See Figure 18-35.

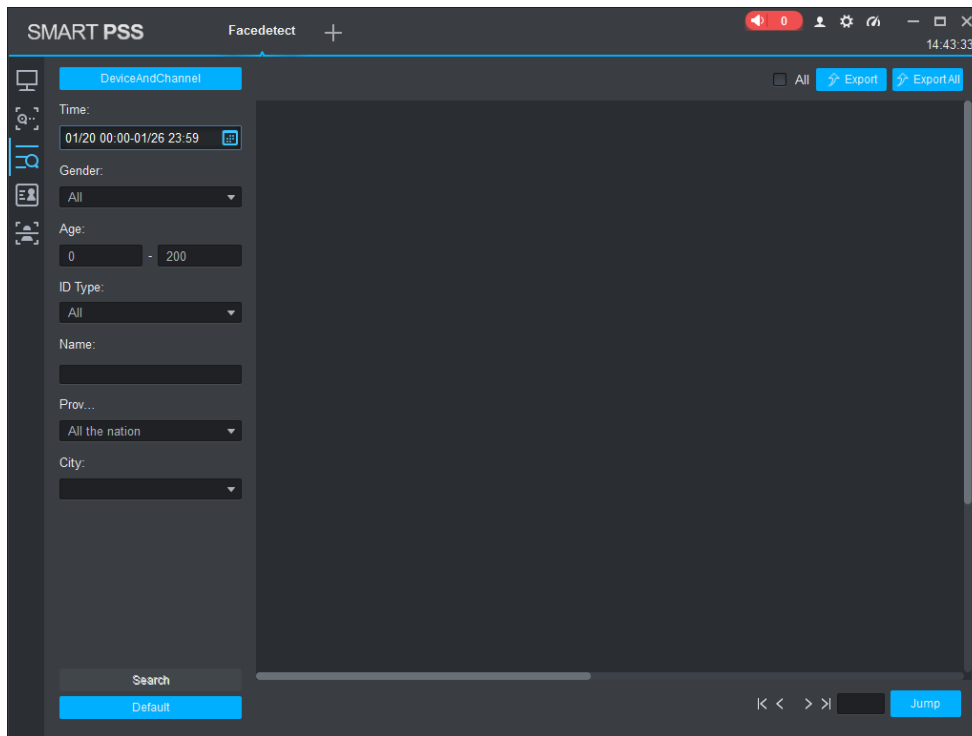

Figure 18-35

Step 2

Set up the search conditions and search for results.

1. Click Device and Channel to select Device and Channel. See Figure 18-36.

NOTE

You can select multiple devices and multiple channels.

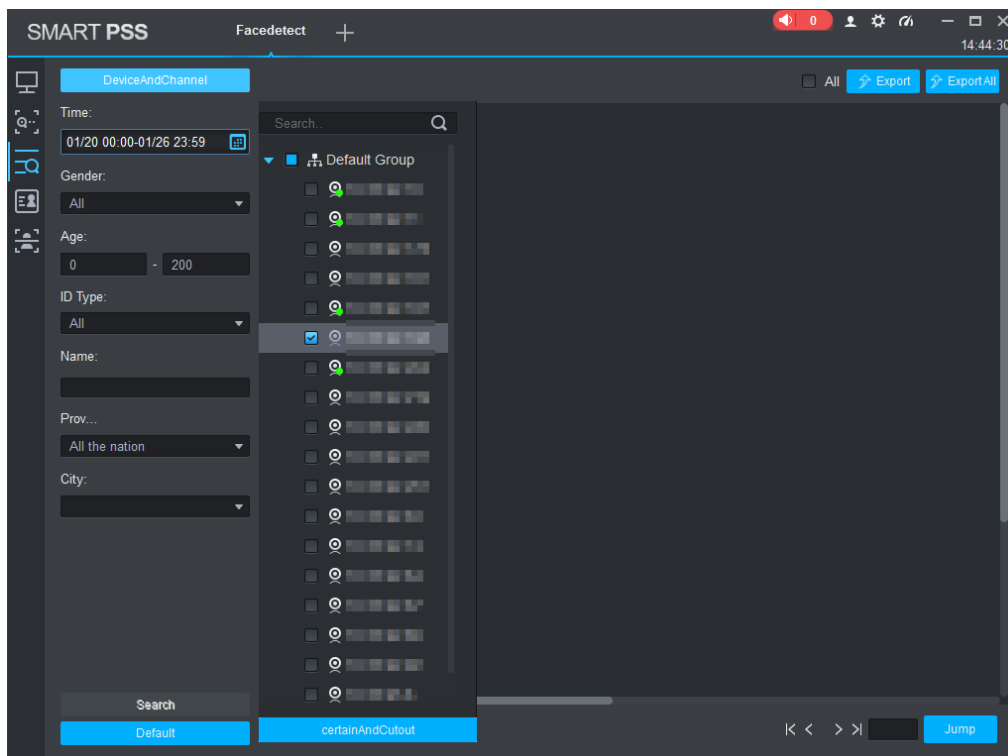

Figure 18-36

2. Set up **Time**, **Gender**, **Age**, and other conditions.

🔑 TIPS

To quickly clear settings and search results, click **Default**.

Step 3

Click **Search**.

The system displays the search results. See Figure 18-37.

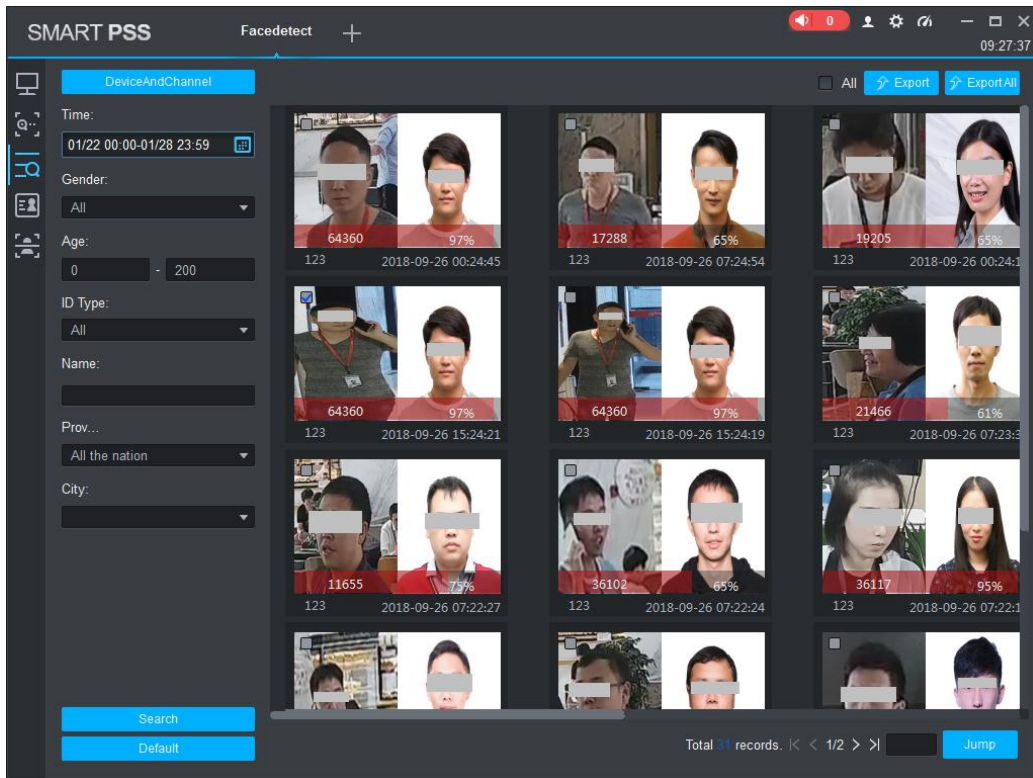

Figure 18-37

Step 4

Double-click the search results to review comparison details. See Figure 18-38.

Get the associated videos on the right from the face recognition devices. If no videos are saved on the devices, SmartPSS cannot review these videos.

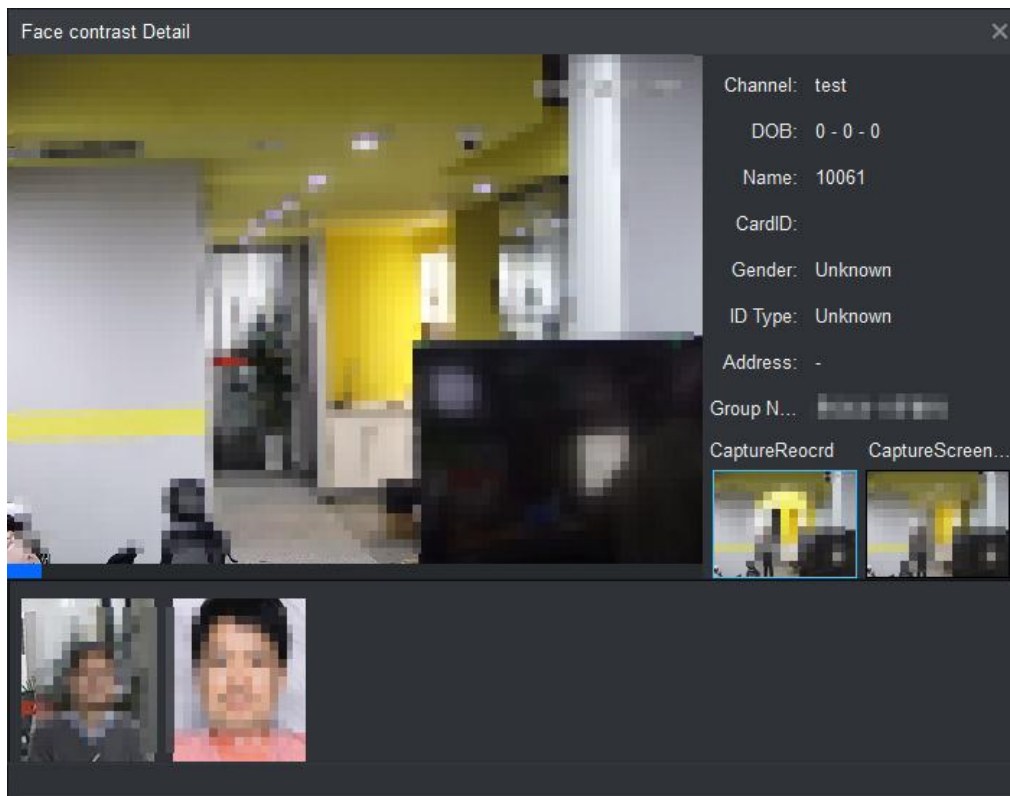

Figure 18-38

Step 5

Export search result.

- This function lets you export search results.

Select the exported search results, click **Export**, and follow on-screen instructions to locally save the results in the xls format.

TIPS

Clicking **All** can quickly select all search results in the current interface.

- Export all results

Click Export All, and follow on-screen instructions to locally save all results in the xls format.